



Totally Focused. Totally Independent.

EN

User manual

Self-regulating Alternators

Series ECO 38
Series ECO 40
Series ECO 43
Series ECO 46

Operating and maintenance instructions

Code: en_GB
Revision: 1
Date: 17/09/19 10:03

Translation of original language



The world's largest
independent producer of
alternators 1 – 5,000kVA

Contents	1
1 General Information: scope of the manual	1
1.1 Intended Users	1
1.2 Professional Profiles Involved	1
1.3 Manual use and storage	1
1.4 How to consult the manual	3
1.4.1 Description of the symbols/pictographs in the manual	3
1.5 Reference Regulations and Directives	4
1.6 Marking data	5
1.7 Declaration of Conformity	6
1.8 Support	8
1.9 Glossary	8
2 Alternator Overview	9
2.1 Main components	9
2.1.1 DSR Digital Regulator	10
2.1.2 DER1 Digital Regulator	10
2.2 General description and working principle	10
2.3 Technical Data	11
2.3.1 IP Protection Rating	11
2.3.2 Radial Loads	11
2.3.3 Noise level [dB(A)]	11
2.3.4 Weight	12
2.3.5 Air volumes [m ³ /min] for local alternators	12
2.3.6 Alignment tolerances in B3B14	13
2.3.7 Positioning dimension in MD35	13
2.3.8 Resistance of windings at 20°C ambient temperature	14
2.3.9 Overall dimensions	15

2.3.10 Materials	23
2.4 Operating ambient requirements	23
3 Safety	25
3.1 General Instructions	25
3.2 Alternator Safety devices	26
3.3 Safety tags	27
3.4 Personal Protective Equipment	28
3.5 Residual risks	28
4 Transportation, movement and storage	29
4.1 General Instructions	29
4.2 Packing materials lifting and transportation	30
4.3 Unpacking	30
4.4 How to dispose of the packing materials	30
4.5 Alternator Movement	31
4.6 Storage	31
5 Installation instructions / drive motor coupling	33
5.1 Installation Setup	33
5.2 Unpacking and disposal of packing materials	33
5.3 Mechanical coupling	34
5.3.1 Alternator Preparation	35
5.3.2 Aligning the drive motor to the B3B14 alternator	35
5.3.3 Aligning the drive motor to the MD35 alternator	36
5.3.4 Thermal Expansion Compensation	36
6 Electrical connection	39
6.1 Terminal board configurations	42
6.1.1 ECO 38 regulation box and cable connection	42
6.1.2 ECO 40 regulation box and cable connection	43

6.1.3 ECO 43 regulation box and cable connection	44
6.1.4 ECO 46 regulation box and cable connection	45
6.2 Parallel connection of alternators	46
6.2.1 Installation of a parallel device (series 38)	46
7 Startup Instructions	49
8 Electronic regulators	51
8.1 DSR Digital Regulator	51
8.1.1 Stability Adjustment	52
8.1.2 Protections	54
8.1.3 Inputs and Outputs: technical specifications	55
8.2 DER1 Digital Regulator	58
8.2.1 Stability Adjustment	59
8.2.2 Protections	61
8.2.3 Inputs and Outputs: technical specifications	62
8.3 UVR6-SR7 analog regulators	66
9 Maintenance	69
9.1 General Instructions	69
9.2 Maintenance summary table	70
9.2.1 Summary table of ordinary maintenance operations	70
9.2.2 Summary table of extraordinary maintenance operations	70
9.2.3 Summary table of maintenance operations in case of failure	71
9.3 Ordinary Maintenance	72
9.3.1 General cleaning	72
9.3.2 Air filter cleaning (if present)	73
9.3.3 Visual Inspection	74
9.3.4 Verification of winding state	75
9.3.5 Verification of correct alternator operation	76

9.3.6 Tightening torque check	76
9.3.7 Alternator exterior and interior cleaning	77
9.4 Extraordinary maintenance	78
9.4.1 Maintenance and potential replacement of bearings	78
9.4.2 Winding state and diode bridge fastening check	78
9.4.3 Copy of the alarms of the digital regulator	79
9.4.4 Verification of correct PMG fastening (optional component)	80
9.4.5 Cleaning of windings	81
9.5 Maintenance in case of failure	82
9.5.1 Fan replacement assembly	82
9.5.2 Verification and potential replacement of diode bridge	84
9.5.3 Mechanical disassembly for inspection (40-43-46 series)	85
9.5.3.1 Note for removal of ECO 43 - 46 alternators	90
9.5.4 Mechanical assembling (40 - 43 - 46 series)	91
9.5.5 PMG disassembling	95
9.5.6 PMG assembling (38 series)	96
9.5.7 PMG assembling (40-43-46 series)	96
9.5.8 Removal of disc holder hub	99
9.5.9 Loss of residual magnetism (reexcitation of the machine)	100
9.5.10 Verification and replacement of voltage regulator	101
9.5.11 DSR test and setup on test bench	104
9.5.12 DER1 test and setup on test bench	106
9.5.13 DER 2 test and setup on test bench	108
9.5.14 Main stator windings voltage test	110
9.5.14.1 Resistance/Continuity Test	111
9.5.14.2 Insulation Test	112
9.6 General Tightening Torques	114

9.6.1 ECO38 Series	114
9.6.2 ECO40 Series	116
9.6.3 ECO43 Series	118
9.6.4 ECO46 Series	120
9.7 Disc Tightening Torques	122
9.8 Terminal block Tightening Torques	122
10 DSR / DER1 alarm management	123
10.1 DSR/DER1 digital regulator alarms	124
11 Problems, causes and solutions	127
12 Electrical diagrams	129
12.1 DSR digital regulator electrical diagrams	130
12.2 DER 1 digital regulator electrical diagrams	133
12.3 Electrical diagrams with PMG	144
12.4 Electrical diagrams with UVR6 - SR7 regulators	149
13 Replacement parts	157
13.1 ECO 38A Construction type MD35	158
13.2 ECO 38A Construction type B3B14	160
13.3 ECO 40B Construction type MD35	162
13.4 ECO 40B Construction type B3B14	164
13.5 ECO 43A Construction type MD35	166
13.6 ECO 43A Construction type B3B14	168
13.7 ECO 46A Construction type MD35	170
13.8 ECO 46A Construction type B3B14	172
14 Dismantlement and disposal	175

1 General Information: scope of the manual

This manual is intended to provide support and guidance during the stages of work on the alternator. It contains information on the use, maintenance and handling of faults and malfunctions providing indications for the most adequate behavior to the correct use and to the correct operation of the machine as specified by the Manufacturer.

This manual is an essential safety requirement and it must accompany the alternator throughout its life cycle. It is indispensable to store this manual and to make it available to everyone involved in using and servicing the alternator.



This document and/or its parts may not be reproduced or disclosed to third parties without the prior consent of MECC ALTE S.p.A.



MECC ALTE S.p.A. is not responsible or liable for any damages suffered by people or things as a result of improper use not indicated in this manual and by failure to comply with the specifications of the technical characteristics table pertaining to every model.

1.1 Intended Users

This manual is intended for the authorized personnel adequately trained to operate this kind of product.



Warning

The operators must not carry out operations reserved to maintenance technicians or to specialized technicians. The Manufacturer disclaims all responsibility for damages suffered as a result of failure to comply with this warning.

1.2 Professional Profiles Involved

Below we describe the professional profiles who may operate the alternator based on the kind of activity to be carried out.

Handler



Authorized skilled personnel able to safely lift and handle the alternator. The operator is not authorized to carry out maintenance operations.

Mechanical maintenance technician



A qualified technician able to carry out the installation, adjustment, maintenance and ordinary repair operations required. Not allowed to carry out operations with the power on.

Electrical Maintenance Operator



A qualified technician in charge with all the electrical works of connection, adjustment, maintenance and repair. Authorized to carry out operations with the power on.

Field Service Technician



A qualified technician provided by the manufacturer to carry out complex operations in special cases or, anyway, as previously agreed with the user.

1.3 Manual use and storage

Warning



Read this manual carefully before starting up the alternator or carrying out any operation on it. If you do not read it you might not be able to recognize potential hazardous situations that may lead to death or serious injuries inflicted to yourself or to others.

This manual is intended to provide all the information required for a correct use of the alternator and its most autonomous and safest possible management.

It is mandatory for all the users and the maintenance technicians to carefully read the instructions contained in this manual and in all possible annexes, before carrying out any operation on the product.

In case of doubts on the correct interpretation of the information reported in the documentation, please contact the manufacturer for clarifications.

Caution



Keep this manual and all its annexes in good condition, legible and complete in all its parts. Keep the documentation close to your alternator, in an accessible place known to all the operators and maintenance technicians and, more generally, to everyone who for various reasons should operate the alternator.

Warning



Keep the manual in its original condition. It is forbidden to rewrite, change or remove pages from the manual and their contents. The manufacturer disclaims all responsibility for any potential damages to people, animals or things as a result of failure to comply with the instructions and with the operational modalities described in this manual.



This manual is an integral part of the alternator and it must be stored for future reference.

Caution



This manual must be delivered together with the alternator in case the alternator is transferred/sold to another user.

Caution



In case the manual is lost or damaged ask for a copy from the Manufacturer indicating its identification data: document name, code, revision number and issue date.

1.4 How to consult the manual

- The manual is divided in chapters, paragraphs and subparagraphs listed in the table of contents: an easy way to find any topic of interest.
- The symbols used provide direct knowledge on the kind of information expressed by each symbol. For instance the symbol:



This symbol indicates a NOTE.

1.4.1 Description of the symbols/pictographs in the manual

Below you will find the various symbols used in the manual to highlight information of particular importance or the intended recipients of the specific pieces of information.



Danger

The risks described in this manner indicate a HIGH LEVEL of hazard that, unless avoided, could cause severe injuries or death.



Warning

The risks described in this manner indicate an INTERMEDIATE LEVEL of hazard that, unless avoided, could cause severe injuries or death.



Caution

The risks described in this manner indicate a LOW LEVEL of hazard that, unless avoided, could cause minor or moderate injuries.



This symbol indicates a NOTE; a fundamentally important piece of information or in-depth explanation.



This symbol indicates a CROSS REFERENCE; the presence of a module, of a drawing or of an annexed document that should be consulted and, if required, filled in.

1.5 Reference Regulations and Directives

List of the reference regulations and directives used for the design and construction of the alternator.

Directives

- Machinery Directive 2006/42/EC.
- Low Voltage Directive 2014/35/EC.
- EMC Directive 2014/30/EC.

Applicable Harmonized Technical Standards

- EN ISO 12100 (2010) : Safety of machinery – General principles of design – Risk assessment and risk reduction
- EN 60034-1 : Rotating Electrical Machines - Part 1 : Rating and performance.
- EN 60204-1: Safety of machinery. Electrical equipment of machines. Part 1: General Requirements
- EN61000-6-3 : Electromagnetic Compatibility (EMC) Part 6-3: Generic Standards - Emission standard for Residential, Commercial and Light-industrial Environments.
- EN61000-6-2 : Electromagnetic Compatibility (EMC) Part 6-2: Generic Standards - Immunity for industrial environments

Applicable Technical Standards

- EN 60034-2 : Method for determining losses and efficiency
- EN 60034-5 : Classification of degrees of protection (IP).
- EN 60034-6 : Methods of cooling (IC)
- EN 60034-7 : Types of construction (IM code)
- EN 60034-8 : Terminal markings and direction of rotation
- EN 60034-9 : Noise limits
- EN 60034-14 : Mechanical vibration limits
- EN 60085 : Classification of insulating materials
- ISO 1940-1 : Balance quality requirements of rigid rotors

Technical standards to be applied by the installer

- ISO 8528-9 : Reciprocating internal combustion engine driven alternating current generating sets Part 9: Measurement and evaluation of mechanical vibrations.

1.6 Marking data

Alternator Nameplate

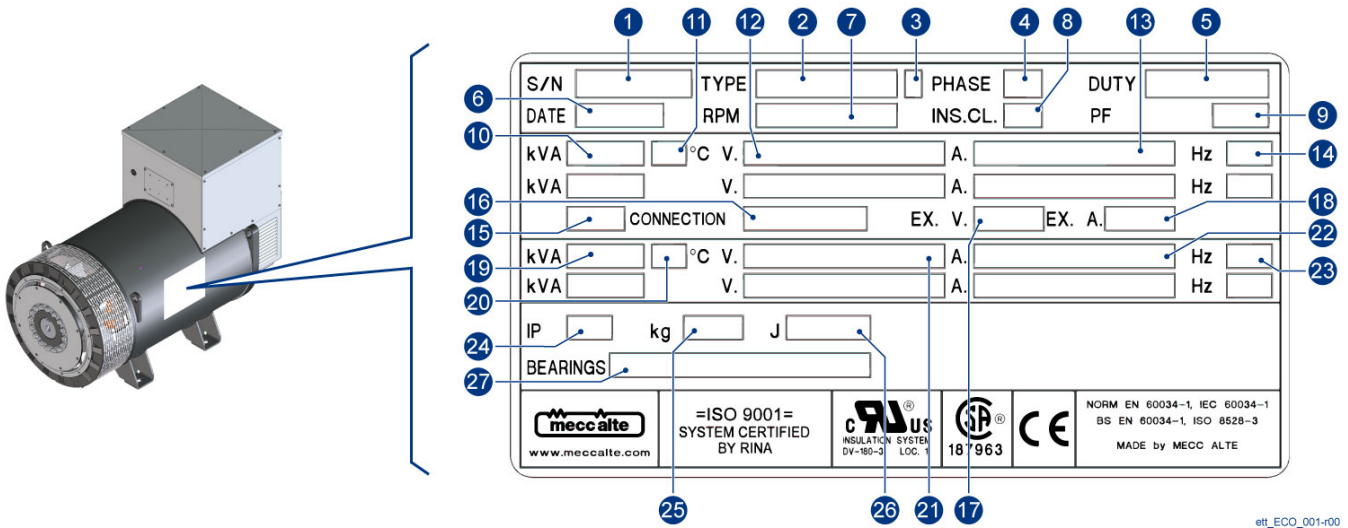

- | | |
|---|---------------------------------------|
| 1. Serial number | 15. Nominal characteristics class |
| 2. Model | 16. Connection type |
| 3. Revision index | 17. Excitation Voltage |
| 4. Phase number | 18. Excitation Current |
| 5. Service type | 19. Power related to temperature (20) |
| 6. Manufacture month / year | 20. Ambient temperature |
| 7. Nominal speed | 21. Nominal Voltage |
| 8. Insulation class | 22. Current related to power (19) |
| 9. Power factor | 23. Nominal Frequency |
| 10. Nominal power related to temperature (11) | 24. Protection Rating |
| 11. Maximum ambient temperature | 25. Total weight |
| 12. Nominal Voltage | 26. Moment of inertia |
| 13. Nominal Current | 27. Bearing type |
| 14. Nominal Frequency | |



Ask for a new nameplate if the one attached to the alternator cannot be read anymore.

The nameplate is affixed on the alternator in the position indicated in the figure.

1.7 Declaration of Conformity



Below a copy of the declaration of conformity of the product. The original is placed inside the terminal box of every alternator. A true copy may be requested in case of loss.

DICHIARAZIONE DI CONFORMITA'	CONFORMITY DECLARATION	DECLARATION DE CONFORMITE'	KONFORMITÄTS ERKLÄRUNG	DECLARACION DE CONFORMIDAD
CE				
Noi,	We,	Nous,	Wir,	Notros,
dichiaro sotto la nostra sola responsabilità che la macchina	declare under our sole responsibility that machine	declaron sous notre responsabilité que la machine	erkären unter unsere Verantwortlichkeit, daß die Maschine	declaramos bajo nuestra exclusiva responsabilidad que la máquina
<div style="border: 1px solid black; width: 100%; height: 100%; display: flex; align-items: center; justify-content: center;"> </div>				
<p>come descritta nella documentazione allegata e nei nostri archivi, è in conformità con la direttiva 2006/42, alla direttiva 2014/35, alla direttiva 2014/30, alle norme europee EN ISO 12100, EN 60204-1, EN 61000-6-2, EN 61000-6-3, EN 60034-1.</p> <p>Questa macchina non può essere messa in servizio prima che la macchina in cui sarà assemblata, sia stata dichiarata conforme alle disposizioni della direttiva macchine 2006/42/CEE.</p>	<p>as described in the attached documentation and in our files, is in conformity with the 2006/42 directive, with 2014/35 directive, with 2014/30 directive, with EN ISO 12100, EN 60204-1, EN 61000-6-2, EN 61000-6-3, EN 60034-1 european norms.</p> <p>This machine must not be put into service until the machine in which it is intended to be incorporated into, has been declared in conformity with the provisions of 2006/42/CEE machinery directive.</p>	<p>comme decrite dans la documentation jointe et dans nos archives, est en conformité avec la directive 2006/42, à la directive 2014/35, à la directive 2014/30 et aux normes européennes EN ISO 12100, EN 60204-1, EN 61000-6-2, EN 61000-6-3, EN 60034-1.</p> <p>L'utilisation de l'alternateur n'est pas autorisée avant que l'ensemble alternateur et système d'entraînement, soit déclaré conforme aux dispositions de la directive 2006/42/CEE.</p>	<p>in der anliegenden Dokumentation in unserer Beschreibung, mit der Richtlinie 2006/42, mit der Richtlinie 2014/35, mit der Richtlinie 2014/30 und mit den Europäischen Vorschriften EN ISO 12100, EN 60204-1, EN 61000-6-2, EN 61000-6-3 und EN 60034-1, konform ist.</p> <p>Der Betrieb der o.g. Maschine nach dem Zusammenbau darf nur dann erfolgen, wenn die Vorschriften der Maschinenrichtlinien 2006/42/EWG eingehalten werden.</p>	<p>como descrita en la documentación adjunta y en nuestros archivos es conforme con la directiva 2006/42, con la directiva 2014/35, con la directiva 2014/30, a los normas europeas EN ISO 12100, EN 60204-1, EN 61000-6-2, EN 61000-6-3 y EN 60034-1.</p> <p>Esta máquina no puede ser puesta en servicio antes que la máquina resultante, con la cual será acoplada, sea declarada conforme con los disposiciones de la directiva máquinas 2006/42/CEE.</p>
Posizione / Position / Position / Stellung / Position Nome e cognome / First name and surname / Nom et prenom / Vor-und Nachname / Nombre y apellido Firma / Signature / Signature / Unterschrift / Firma				#Presidente DIEGO CARRARO
Questa macchina è stata prodotta in: / This machine was produced in: / Cette machine a été produite en: / Diese Maschine wurde produziert: / Esta máquina se produjo en:				
<input checked="" type="checkbox"/> MECC ALTE via ROMA 20, 38051 Cressano, Vicenza ITALY P. IVA 01267440244 TEL +39 0444 396111 FAX +39 0444 396168 info@meccalte.it	<input type="checkbox"/> MECC ALTE ITALY via VOLTATI, 1, 37038 Soave, Verona ITALY P. IVA 01267440244 TEL +39 0444 396111 FAX +39 0444 396168 info@meccalte.it	<input type="checkbox"/> MECC ALTE UK LTD 6 LANG'S END WAY OAKHAM RUTLAND UK VAT GB 690 7302 32 +44 01572 771160 +44 01572 771161 info@meccalte.co.uk	<input type="checkbox"/> MECC ALTE ALTERNATOR (SHANGHAI) LTD 755 NANHAI EAST ROAD JIANGSU HAIMEN ECONOMIC DEVELOPMENT AREA PRC VAT 320684785587760 (86) 0513-82325768 (86) 0513-82325768 info@meccalte.cn	<input type="checkbox"/> MECC ALTE INDIA PVT LTD PLOT NO. 1 SANASWADI TALEGAON DHANUWERE ROAD TALUKA: SHIRUR, DISTRICT: PUNE 412208 MAHARASHTRA INDIA TEL. +91 2137 61900 FAX +91 2137 619999 info@meccalte.in
www.meccalte.com				
LA LISTA DEI RISCHI RESIDUI SI TROVA SUL RETRO DI QUESTO FOGGIO.	RESIDUAL RISKS LIST IS ON THE BACK OF THIS SHEET.	LA LIST DES RISQUES RESIDUELS EST SUR LA PARTIE VERSO DE CE FEUILLET.	DIE LISTE DER NACHBLEIBENDEN GEFAHREN BEFINDET SICH AUF DER RÜCKSEITE VON DIESEM BLATT.	LA LISTA DE LOS RIESGOS RESIDUALES SE ENCUENTRA DEL OTRO LADO DE LA PAGINA.
Questa dichiarazione è in conformità ai criteri generali indicati dalla norma europea EN17050.	This declaration is in conformity with the general criteria indicated by EN17050 european standard.	Cette declaration est en conformité aux critères générales indiqués de la norme européenne EN17050.	Diese Erklärung ist konform mit dem allgemeinen Kriterien der Europäischen Vorschrift EN17050.	Esta declaración es conforme a los criterios generales indicados por la norma europea EN 17050.

Mod. CE rev. 014 - IT

LISTA DEI RISCHI RESIDUI.

La MECC ALTE ha fatto tutto il possibile per fabbricare il generatore con il massimo della conoscenza sulle sicurezze in Suo possesso e consultando tutte le Direttive e Norme attualmente applicabili.

Il manuale d'uso ed istruzione riporta passo-passo tutte le indicazioni richieste dal punto 1.7.4 (istruzioni d'uso) della Direttiva Macchine ed è fatta specifica richiesta di leggerlo attentamente così' da non incorrere in operazioni errate che, se pur minime, possono arrecare danni alle persone. Se vengono rispettate tutte le indicazioni fornite, non rimangono particolari rischi residui, ma solamente delle attenzioni che sono di :

- 1) movimentare il generatore con accortezza (imballato e disimballato)
- 2) far accoppiare il generatore alla macchina di trascinamento e far collegare elettricamente lo stesso, da personale adeguatamente istruito
- 3) non toccare il generatore durante il funzionamento e subito dopo l'arresto dello stesso, in quanto vi potrebbero essere parti del generatore a temperature elevate.

RESIDUAL RISKS LIST.

The manufacturer MECC ALTE took all possible precautions to construct the generator following all safety regulations and present applicable Safety Norms.

The instruction manual explains step by step all indications required in point 1.7.4 (user instructions) of the Machines Directive and all users are specifically asked to read it carefully in order to avoid wrong operations which, even though simple, could cause damage to persons. If all instructions given are followed, no residual risks are left ; however, one has to pay attention to the warnings given :

- 1) move carefully the generator (packed and unpacked)
- 2) the coupling of the generator with the drive-machine and the electrical connections should be performed by skilled personnel
- 3) do not touch the generator during function and immediately after being stopped since some part of the generator could be hot.

LIST DES RISQUES RESIDUELS.

La société Mecc Alte a pris toutes ses précautions pour fabriquer les alternateurs avec un maximum de sécurité à sa connaissance et, en consultant toutes les directives et normes actuellement applicables.

Le manuel d'utilisation et d'instruction explique point par point toutes les indications requises en point 1.7.4 (instruction d'utilisation) de la Directive des machines et, tous les utilisateurs sont spécifiquement sollicités pour lire ceci avec attention afin d'éviter toutes fausses opérations qui, si elles peuvent être minimes, peuvent aussi être dangereuses pour l'utilisateur.

Si toutes les instructions données sont suivies, il n'y a aucun risque résiduel particulier, mais, seulement quelques précautions à prendre qui sont :

- 1) manipuler l'alternateur avec prudence (emballage et déemballage)
- 2) l'accouplement entre l'alternateur avec le système d'entraînement, et les connexions électriques doit être effectué par du personnel qualifié
- 3) ne pas toucher l'alternateur durant son fonctionnement et aussitôt après son arrêt car, certaines pièces peuvent être encore de température élevée.

LISTE DER NACHBLEIBENDEN GEFAHREN.

Der Hersteller MECC ALTE hat alle möglichen Vorsichtsmaßnahmen bei der Herstellung des Generators nach geltenden Sicherheitsvorschriften und den z.Zt. anwendbaren Sicherheitsnormen eingehalten.

Die Bedienungsanleitung erklärt schrittweise alle Indikatoren, die in Pkt.1.7.4 (Gebrauchsanweisung) der Maschinenbauvorschrift gefragt sind. Alle Anwender werden dringend gebeten, diese Anweisungen zu lesen, um auch den kleinsten Fehler zu vermeiden, der Personenschaden verursachen könnte.

Bei genauer Beachtung der Vorschriften bleibt kein Risiko; jedoch müssen die folgenden Warnungen beachtet werden :

- 1) den Generator verpackt und unverpackt vorsichtig transportieren
- 2) die Kopplung des Generators an die Antriebsmaschine und die elektrischen Verbindungen nur durch qualifiziertes Personal ausführen lassen.
- 3) den Generator während des Betriebs und kurz nach dem Abstellen nicht berühren, da Teile des Generators heiß sein können.

LISTA DE LOS RIESGOS RESIDUALES.

La MECC ALTE ha hecho todo el posible para fabricar el generador con los máximos conocimientos sobre seguridad en su poder, y consultando todas las directivas y normas actualmente aplicables.

El manual de uso e instrucciones explica paso a paso todas las indicaciones requeridas por el punto 1.7.4 (instrucciones de uso) de la Directiva Máquinas, y hace una particular solicitud de leer atentamente el mismo, de manera de evitar operaciones erradas, que si bien mínimas, podrían provocar daños a las personas.

Si son respetadas todas las indicaciones dadas, prácticamente no quedan riesgos residuales, a parte los siguientes puntos :

- 1) manipular el generador con cuidado (embalado y desembalado)
- 2) acoplar el generador con la máquina que da el movimiento primario, y conectar eléctricamente el mismo, por personal adecuadamente calificado.
- 3) no tocar el generador durante el funcionamiento, así como, inmediatamente después que el mismo se detiene, debido a que podrían existir partes del generador a altas temperaturas.

Mod. CE rev. 014 - IT

1.8 Support

For any inquiry on the use, the maintenance or a request of replacement parts, the buyer must contact the Manufacturer directly (or the help desk if present), specifying the alternator identification data indicated on the nameplate.

The Customer may resort to the technical and commercial support provided by the area representatives or by foreign branches, which are in direct contact with MECC ALTE S.p.A. and have their addresses and contact data indicated on the back cover.

In case of fault or an insurmountable inconvenience, the Customer may contact directly the headquarters using the following data:

PHONE NUMBER (Landline):	+ 39 0444 396111
FAX NUMBER:	+ 39 0444 396166
E-MAIL:	aftersales@meccalte.it
WEBSITE:	www.meccalte.com
MAILING ADDRESS:	MECC ALTE S.p.A Via Roma 36051 Creazzo, Vicenza Italy



In case of ownership transfer or company transfers of the alternator you should always inform the manufacturing company or your reference help desk.

1.9 Glossary

System:	System means, in brief, the drive motor and the alternator.
Installer:	A person / company that is in charge of building the "Fully assembled Machine" and/or installing it at the user's premises.
Fully Assembled Machine:	It is the name of the complete machine mainly made up of a "drive motor" and the alternator.
Drive motor:	It is the motor to which the alternator is connected. The manual also defines it as the "drive machine".
PPE:	Personal Protective Equipment.

2 Alternator Overview

ECO Series alternators are self-regulated, 4-pole brushless alternators.

They are equipped with a rotating inductor (1) fitted with a damper cage and stationary armature with inclined grooves. The winding is short pitched so as to reduce the harmonics.

The electromagnetic compatibility tests were carried out in compliance with the standard specifications, with the neutral wire connected to ground.

Testing in accordance with other specifications may be carried out on request of the customer.

The mechanical structure, always very robust, allows easy access to the connections and inspections of the various components.

The case is made of steel, the shields are made of cast iron, the shaft is made of C45 steel with a fan splined onto the shaft.

The protection rating is IP23 (higher protection ratings can be achieved on request).

Insulation is of class H standard.

The impregnations are realized with polyester resin for the rotating parts and with vacuum treatment for the parts that have higher voltage such as for instance the stators.

Special treatments may also be carried out on request.

2.1 Main components

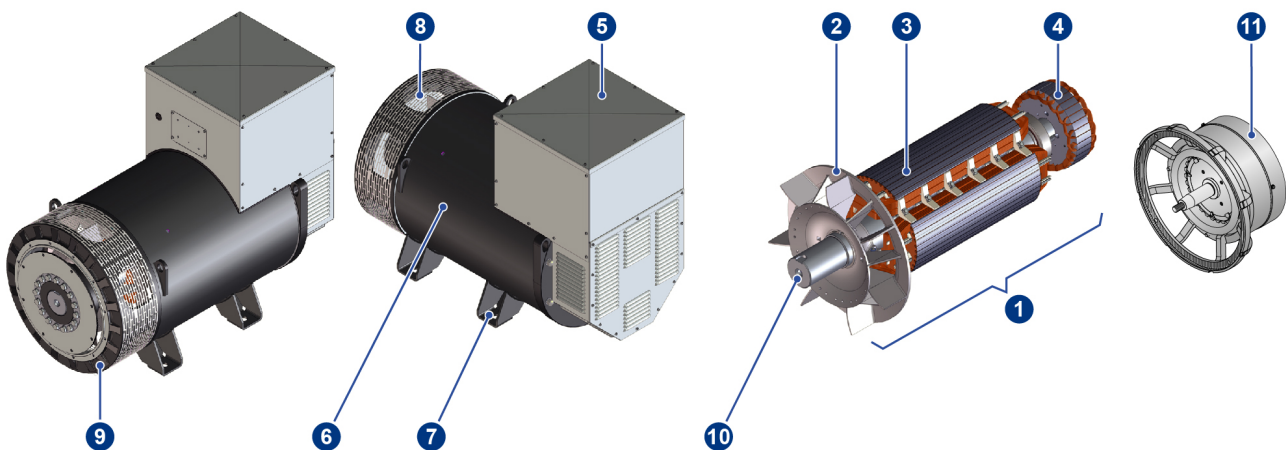

dis_ECO_021-r00

- | | |
|----------------------|--------------------|
| 1. Rotating Inductor | 7. Mounting Feet |
| 2. Cooling fan | 8. Protection Grid |
| 3. Main rotor | 9. Front Cover |
| 4. Exciter Rotor | 10. Shaft |
| 5. Terminal Box | 11. PMG |
| 6. Stator Frame | |

2.1.1 DSR Digital Regulator

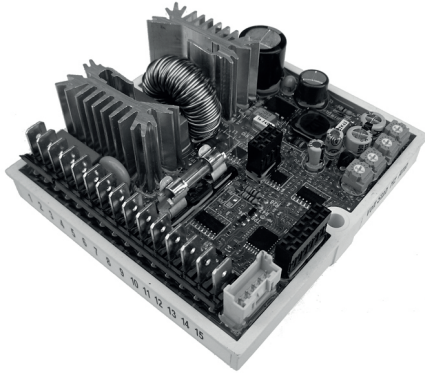

dis_ECO_022-r00

The electronic regulators may be of 2 types: DSR, DSR/A. Standard supply comes with the DSR on the 38 series. DSR/A can be mounted on the 40-43-46 series on customer request. The regulator is normally installed in the terminal box of the alternator.

2.1.2 DER1 Digital Regulator

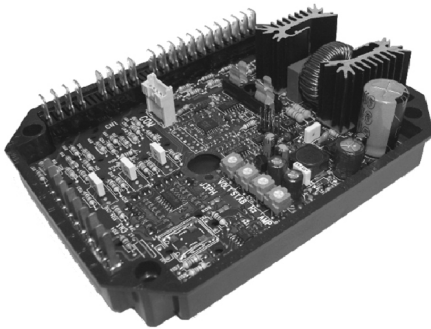

dis_ECO_023-r00

The electronic regulators may be of 2 types: DER1, DER1/A. Standard supply comes with the DER1 on the 40-43-46 series. DER1/A can be mounted on the 38 series on customer request. The regulator is normally installed in the terminal box of the alternator.

2.2 General description and working principle

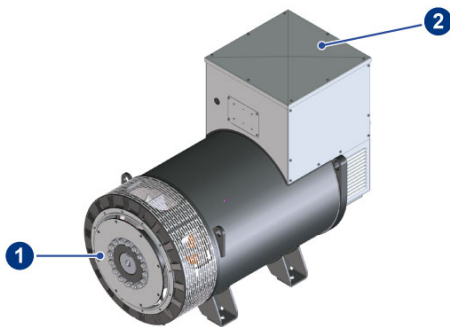

dis_ECO_030-r00

The drive motor is connected to the flange and disks (1) of the alternator. The alternator rotor, started up by the drive motor, generates electricity. The cables for the electric power supply to the user are connected on the terminal block inside the "terminal box" (2).

The DSR/DER1 digital regulators are equipped with an LED Indicator. During normal operation the LED blinks with a 2-second period and a 50% duty cycle (1 second on, 1 second off), in case of faults it flashes differently.



See diagrams in chapter 10 "Alarm Management".

2.3 Technical Data

2.3.1 IP Protection Rating

The alternator is built with an IP23 protection rating.

2.3.2 Radial Loads

Maximum allowable radial loads applied to shaft projection, for double-bearing alternators.

Series	Radial force [N]
ECO 38	16000
ECO 40	16000
ECO 43	19000
ECO 46	30000

2.3.3 Noise level [dB(A)]

Series	50 Hz		60 Hz	
	1 m	7 m	1 m	7 m
ECO 38	82	69	86	73
ECO 40	94	82	98	88
ECO 43	95	84	99	99
ECO 46	97	86	100	91

2.3.4 Weight



Weights for MD35 construction type alternators.

Series	Model	Weight [Kg]
ECO 38	1S4 A	530
	2S4 A	573
	3S4 A	602
	1L4 A	692
	2L4 A	790
	3L4 A	930
ECO 40	1S4 A	1024
	2S4 A	1100
	3S4 A	1152
	1L4 A	1305
	1.5L4 A	1400
	2L4 A	1560
	VL4 A	1693
ECO 43	1S4 A	1920
	2S4 A	2140
	1M4 A	2275
	2M4 A	2370
	2L4 A	2700
	VL4 A	2980
ECO 46	1S4 A	3005
	1.5S4 A	3375
	2S4 A	3560
	1L4 A	3805
	1.5L4 A	4255
	2L4 A	4375
	VL4 A	5120

2.3.5 Air volumes [m³/min] for local alternators

Series	50 Hz	60 Hz
ECO 38	32	39
ECO 40	54	64.8
ECO 43	90	108
ECO 46	135	162

2.3.6 Alignment tolerances in B3B14

Tolerance table of drive motor alignment with the alternator.

RPM	Radial tolerance (mm)	Angular tolerance (mm / 100 mm)
1200	0.08	0.05
1500	0.06	0.05
1800	0.05	0.05
3000	0.04	0.05
3600	0.03	0.05

2.3.7 Positioning dimension in MD35

Positioning dimension for flywheel referred to flange face.

Series	SAE	L (mm)
ECO 38	11 ½	39.6
	14	25.4
ECO 40	14	25.4
	18	15.7
ECO 43	14	25.4
	18	15.7
	21	0
ECO 46	18	15.7
	21	0

2.3.8 Resistance of windings at 20°C ambient temperature

Resistance of windings at 20°C ambient temperature						
Type	V/Hz	Alternator			Exciter	
		Stator $\Omega (\pm 5\%)$	Rotor $\Omega (\pm 5\%)$	Auxiliary winding $\Omega (\pm 5\%)$	Stator $\Omega (\pm 5\%)$	Rotor PHASE-PHASE $\Omega (\pm 5\%)$
ECO38 1S4 A	115/200/230/400 - 50	0,0130	3,905	0,854	15,28	0,685
ECO38 2S4 A	115/200/230/400 - 50	0,0105	4,133	0,845	15,28	0,685
ECO38 3S4 A	115/200/230/400 - 50	0,0085	4,449	0,778	15,28	0,685
ECO38 1L4 A	115/200/230/400 - 50	0,0065	4,887	0,796	15,28	0,685
ECO38 2L4 A	115/200/230/400 - 50	0,0055	5,604	0,751	15,28	0,685
ECO38 3L4 A	115/200/230/400 - 50	0,0042	6,780	0,700	15,28	0,685
ECO40 1S4 B	230/400/460/800 - 50	0,0174	4,488	0,558	8,85	0,317
ECO40 2S4 B	230/400/460/800 - 50	0,0136	4,881	0,521	8,85	0,317
ECO40 3S4 B	230/400/460/800 - 50	0,0140	5,176	0,540	8,85	0,317
ECO40 1L4 B	230/400/460/800 - 50	0,0104	6,025	0,476	8,85	0,317
ECO40 1.5L4 B	230/400/460/800 - 50	0,0090	1,376	0,550	8,85	0,050
ECO40 2L4 B	230/400/460/800 - 50	0,0093	1,500	0,481	8,85	0,050
ECO40 VL4 B	230/400/460/800 - 50	0,0082	1,592	0,300	8,85	0,050
ECO43 1S4 A	230/400/460/800 - 50	0,0110	2,100	0,440	10,63	0,130
ECO43 2S4 A	230/400/460/800 - 50	0,0080	2,300	0,413	10,63	0,130
ECO43 1M4 A	230/400/460/800 - 50	0,0150	2,500	0,523	10,63	0,130
ECO43 2M4 A	230/400/460/800 - 50	0,0150	2,500	0,413	10,63	0,130
ECO43 2L4 A	230/400/460/800 - 50	0,0070	2,800	0,677	10,63	0,130
ECO43 VL4 A	230/400/460/800 - 50	0,0050	2,886	0,400	10,63	0,130
ECO46 1S4 A	230/400/460/800 - 50	0,0020	2,972	0,414	12,72	0,121
ECO46 1.5S4 A	230/400/460/800 - 50	0,0040	3,294	0,350	12,72	0,121
ECO46 2S4 A	230/400/460/800 - 50	0,0010	3,330	0,330	12,72	0,121
ECO46 1L4 A	230/400/460/800 - 50	0,0020	3,970	0,360	12,72	0,121
ECO46 1.5L4 A	230/400/460/800 - 50	0,0020	4,270	0,400	12,72	0,121
ECO46 2L4 A	230/400/460/800 - 50	0,0020	4,310	0,390	12,72	0,121
ECO46 VL4 A	230/400/460/800 - 50	0,0020	4,898	0,310	12,59	0,117

tab_ECO_014-r00

2.3.9 Overall dimensions

ECO 38A Construction type MD35

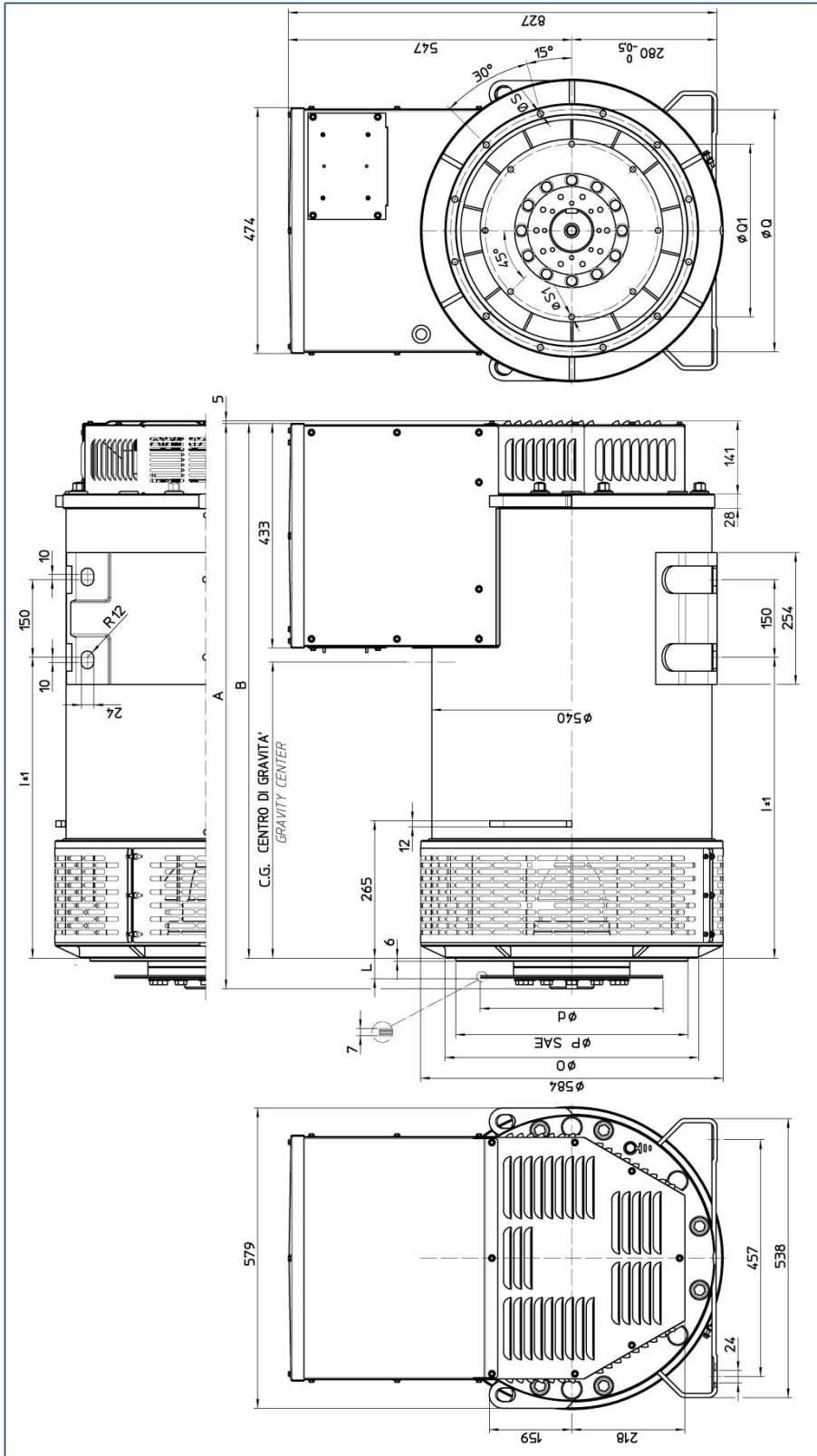

SAE	Giunti a dischi Disc couplings			
	d	L	Q1	S1
11 1/2	352.42	39.6	333.37	11
14	466.72	25.4	438.15	13.5

SAE	Flangia / Flange		
	O	P	Q
3	451	409.36	428.6
2	490	447.7	466.7
1	552	511.2	530.2
1/2	648	584.2	619.1

Serie Series	Modello Model	C.G.	A	B	I
ECO 38	1S/4A	407	880	821	420
	2S/4A	412	880	821	420
	3S/4A	421	1090	1031	580
	1L/4A	480	1090	1031	580
	2L/4A	498	1090	1031	580
	3L/4A	530	1090	1031	580

AP132_01_ECO38A_MD35

ECO 40B Construction type MD35

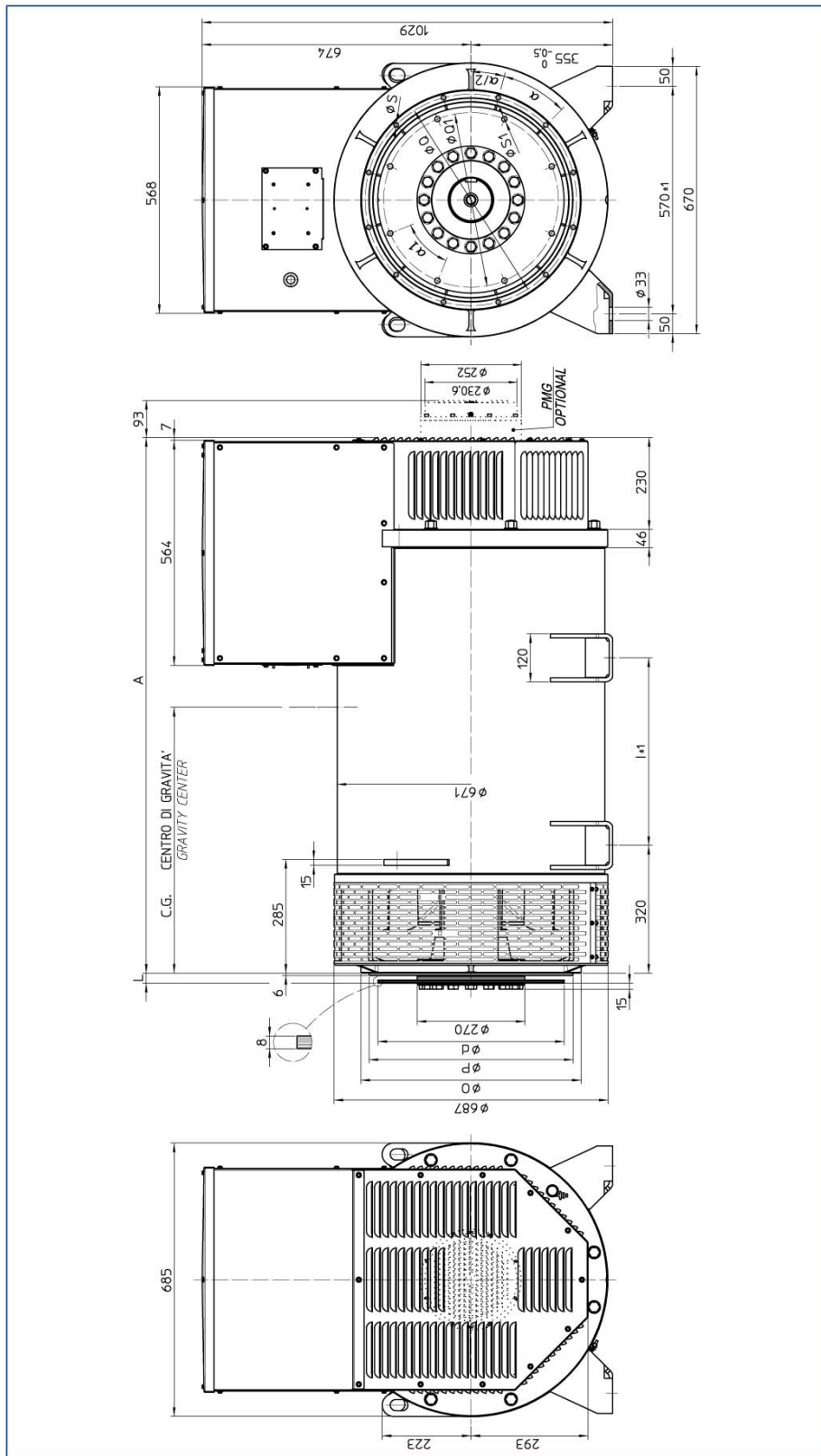

SAE	Giunti a dischi / Disc couplings				
	d	L	Q1	S1	α
14	466.72	25.4	438.15	13.5	45°
18	571.5	15.7	542.92	16.5	60°

SAE	Flangia / Flange				
	O	P	Q	S	α
1	560	511.2	530.2	11	30°
1/2	648	584.2	619.1	14	30°
0	711	647.7	679.5	14	22.5°
00	883	787.4	850.9	14	22.5°

Serie / Series	Modello / Model	C.G. /		A	I	
		Versione / Version	PMG3			
ECO 40	1S/4B	482	504	1076	305	
	2S/4B	494	514			
	3S/4B	505	524	1241	470	
	1L/4B	552	574			
	1.5L/4B	578	597			
	2L/4B	591	609			
		VL/4B	642	659	1341	470

A9520_02_ECO40B_MD35

ECO 40B Construction type B3B14

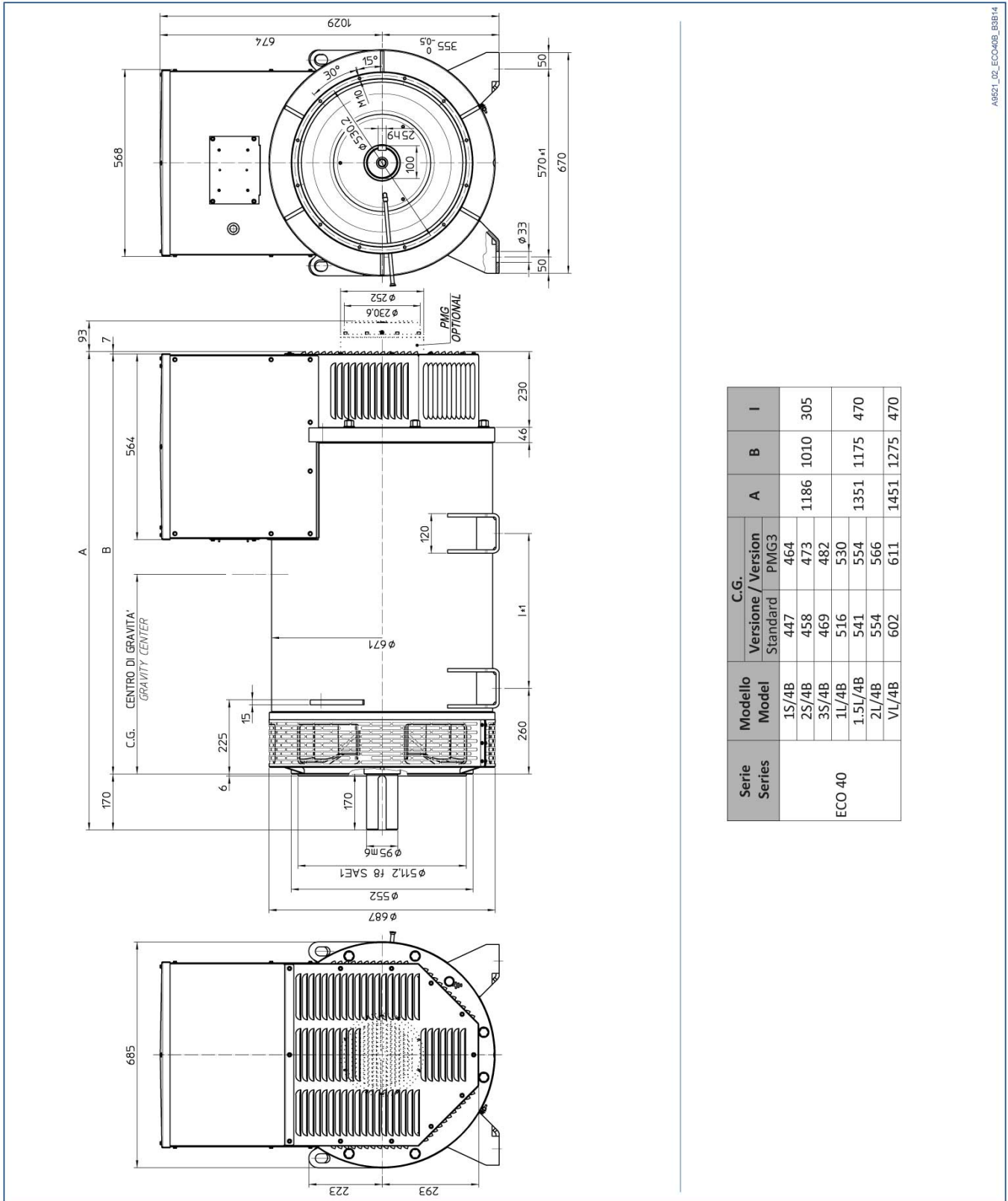

A8521_02_ECO40B_B3B14

ECO 43A Construction type B3B14

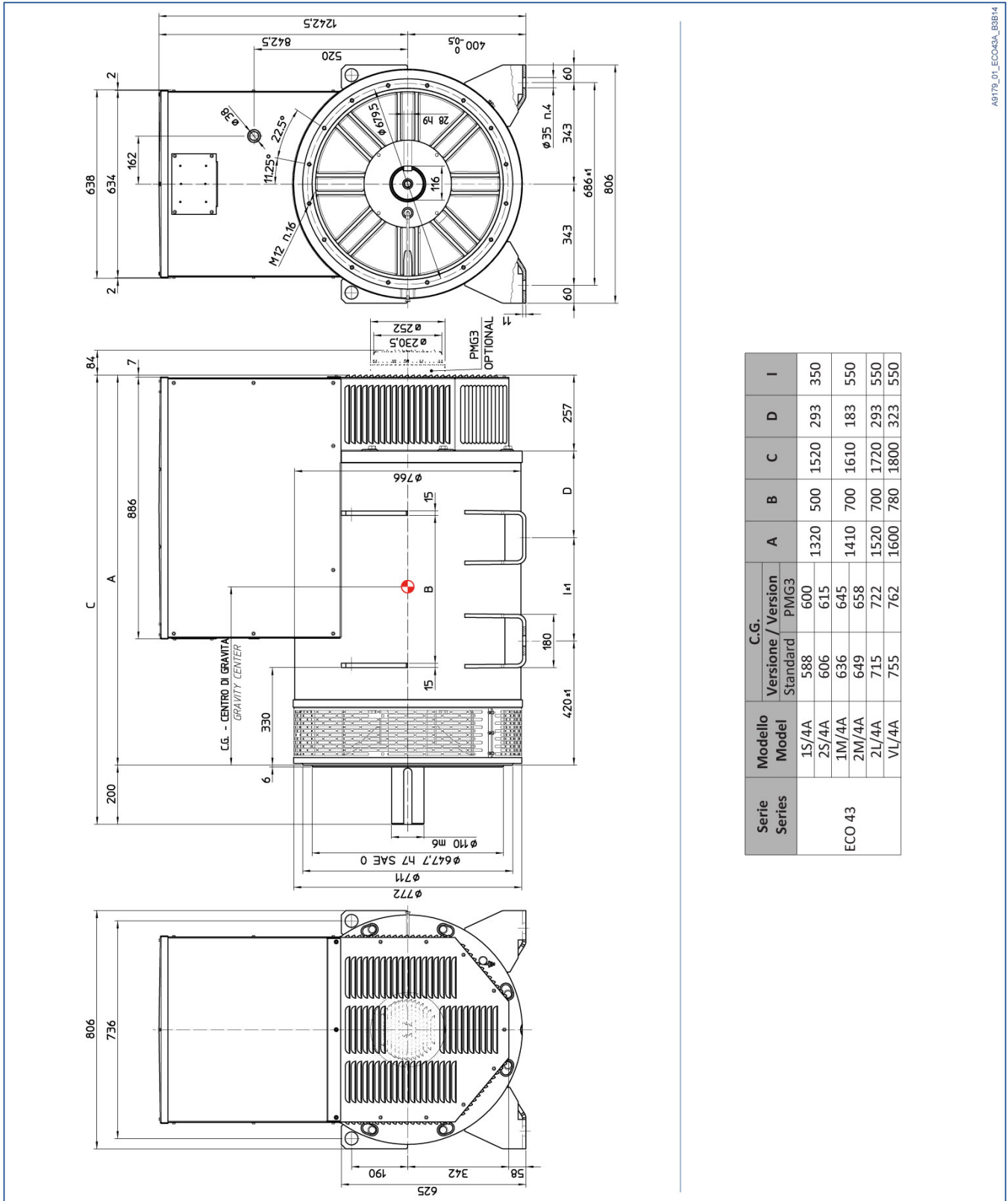

Serie Series	Modello Model	C.G.		A	B	C	D	I
		Versione / Version Standard	PMG3					
ECO 43	1S/4A	588	600	1320	500	1520	293	350
	2S/4A	606	615	1410	700	1610	183	550
	1M/4A	636	645	1410	700	1610	183	550
	2M/4A	649	658	1520	700	1720	293	550
	2L/4A	715	722	1520	700	1720	293	550
	VL/4A	755	762	1600	780	1800	323	550

AB179_01_ECO43A_B3B14

ECO 46A Construction type B3B14

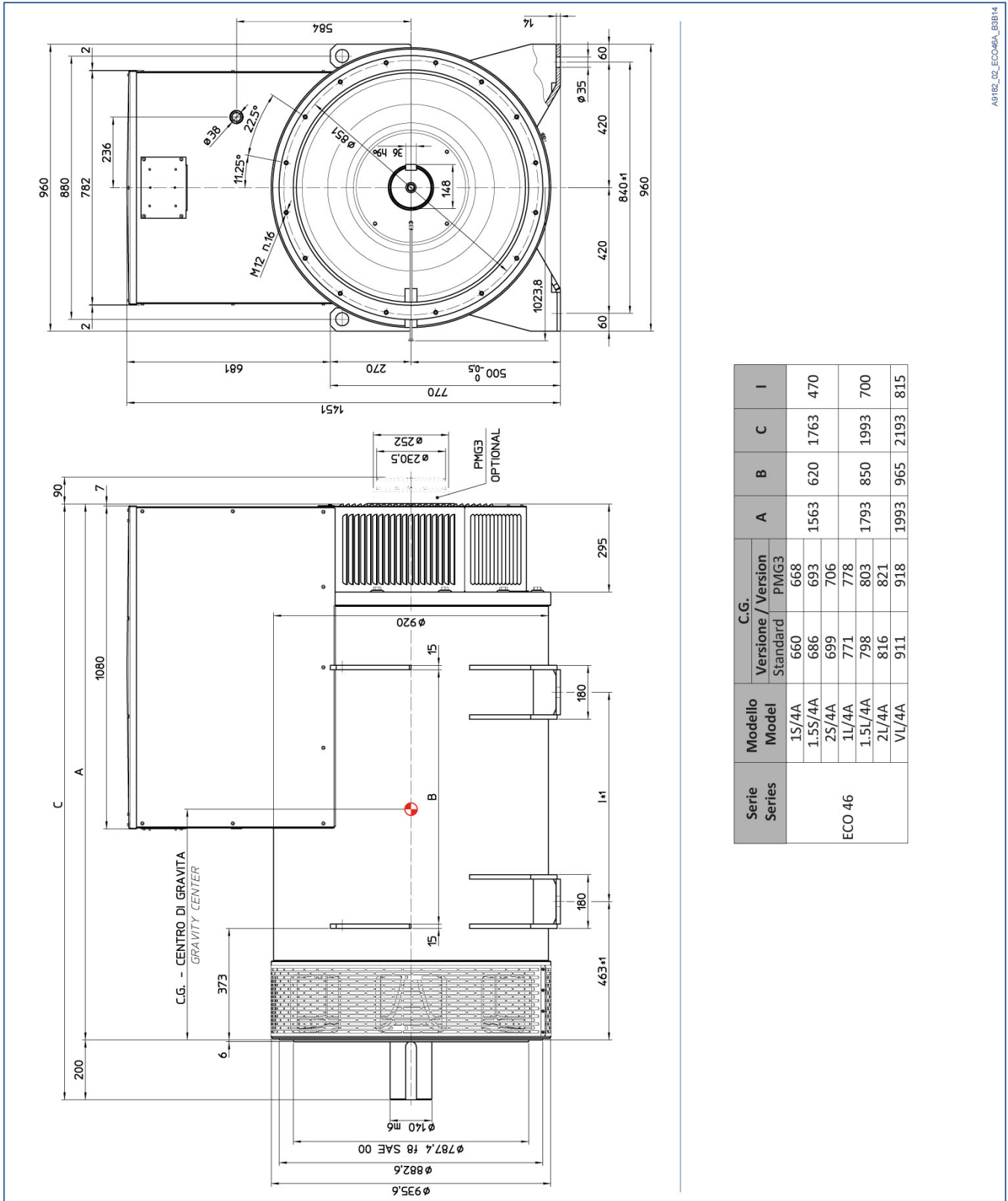

AB182_02_ECO46A_B3B14

2.3.10 Materials

The table below contains the approximate percentages of the materials used in Mecc Alte S.p.A's alternators.

Material	Percentage
Steel Parts	45%
Cast Iron Parts	20%
Copper Parts	20%
Aluminum Parts	10%
Plastic Parts	3%
Electronic parts	2%

2.4 Operating ambient requirements

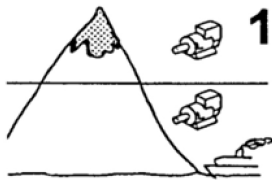

1000m

Max ambient temperature to guarantee the nominal power:

40°C

40°C

Max operating altitude to guarantee the nominal power:

Less than
1000 m.

dis_ECO_032-r00



Install the alternator in a well-aired room. Insufficient ventilation may cause overheating and malfunctioning of the alternator.



For the air volumes required see paragraph 2.3.5.

dis_ECO_038-r00

3 Safety

3.1 General Instructions

The alternator may be used only for the purpose for which it was designed and built.

Caution



The ECO series alternators comply with the Directive 2006/42/EC as amended, therefore they do not pose threats to the operators, if installed, used and serviced in accordance with the instructions provided by Mecc Alte and on condition that the safety devices are kept in perfect state of efficiency.

Danger



Install the alternator only after having read and understood all the sections of this manual.

Danger



Do not operate it while under the influence of intoxicating agents that might delay reaction time such as, for instance, alcohol or drugs.

Danger



The alternator installation, operation and maintenance technicians must be adequately qualified specialists who know the characteristics of the alternators.

Warning



Adequate work clothing is recommended. Avoid wearing chains, bracelets, scarves and cumbersome clothing, long hair must be tied.

Warning



Do not neutralize, remove, alter or otherwise render ineffective any safety, protection or control device of the alternator.

Warning



Maintain the work areas and the routes defined for the installation of the alternator always free from materials and/or elements that may hinder the movement of or cause accidents to the operator.

Caution



The work area must always be adequately lit.

Caution



Keep the floor in the operating area always clean and dry to prevent the forklift truck from sliding sideways when in movement.

Danger



Never operate the alternator with wet hands and objects when it is energized.



Warning

Do not lean on and do not step onto the alternator.



Warning

At the end of each operation that involved removal of the safeguards, put them back and make sure that the correct positioning and efficiency are restored.



Danger

Keep the alternator at a safe distance from flammable materials.



Danger

The alternators, when working, release heat even to a high level based on the power being generated. Before touching it wait for the alternator to cool off.



Danger

Working alternators are noisy (see paragraph 2.3.3). Install the alternator in insulated rooms and wear earmuffs to operate it.

3.2 Alternator Safety devices

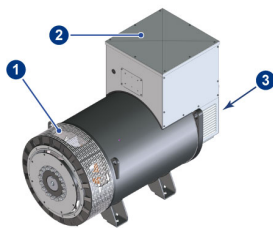

dx_ECO_031-00

The safety devices of the alternator are:

1. Protective net on the front shield.
2. Cover of terminal box.
3. Back latch.



Danger

During the operation of the alternator the safeguards must always be closed.

3.3 Safety tags



Caution

Do not remove under any circumstances the tags attached to the alternator.

The following safety tags are attached to the machine

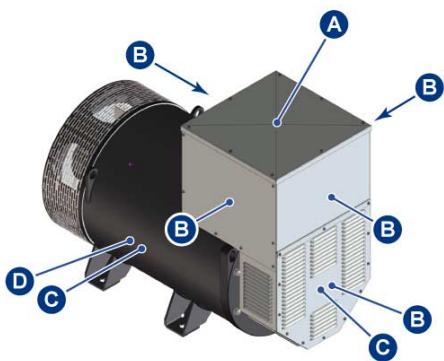

lay_ECO_004-r00

Pos.	Label	Code	Description
A		XXX	Refer to instruction manual before removing covers
B		XXX	Danger!
C		XXX	Danger - Electricity!
D		XXX	Danger - Hot surface!



Caution



The labels must be replaced if they are worn out or cannot be read anymore.

3.4 Personal Protective Equipment



Caution

The staff in charge with the operation of the alternator must wear the personal protective equipment (PPE) indicated in the table below.

PPE	Operation
	Always wear
	Maintenance or lifting the alternator or its components.



Caution

The operator must observe the accident prevention regulations in force in the specific country where the alternator is used.



Caution

The PPE assigned may not be altered.

The manufacturer disclaims all responsibility for any potential damages caused to people by failure to use the PPE.

3.5 Residual risks

The alternator presents the following residual risks:



Danger

Burning risk. The working alternator may release heat even to a high level. Before touching the alternator wait for it to cool off.



Caution

Risk of crushing while lifting. Do not stand under the suspended load, do not come close to it, use adequate PPE.

4 Transportation, movement and storage.

The ECO series alternators are delivered by road on pallets, by sea in fumigated wood cases. Other shipment methods available on customer request.

The cases shipped by sea are covered with nylon to avoid salt infiltration that could compromise the correct operation of the alternator.

Any potential replacement parts are however shipped in cardboard packing that is disposed of according to the local regulations. Packing is always accompanied by a packing list.

Transportation of the packing to the installation place will be provided by the customer.



Upon delivery of the alternator check against the delivery note that there are no missing parts and/or damages; in case there are any, immediately inform the carrier, the insurance company and the reseller or Mecc Alte.

4.1 General Instructions



Warning

The instructions of this chapter must be strictly followed when lifting the alternator.



Warning

Use adequate, tested and certified lifting devices.



Warning

Lifting and transportation must be carried out by members of staff who were trained for this purpose.



Warning

To carry out any lifting, transportation and handling operation wear the PPE indicated by the regulations (see paragraph 3.4).



Warning

When lifting the alternator with the forklift truck keep its forks at the longest possible distance one from the other so as to prevent the alternator from falling or sliding off.

Always make sure that the devices and means for packing materials removal, the alternator and any disassembled part are suitable and undamaged.

4.2 Packing materials lifting and transportation



Danger

Pay attention during all transportation and movement operations. Do not stand under suspended loads.



Warning

Check the packing or the documentation attached to it for the weight to lift, the predefined anchor points and use suitable equipment for the lifting.

4.3 Unpacking



Unpack the alternator carefully without breaking/damaging the packing materials. Both the cases (equipped with metal hinges so that they may be folded) and the pallet must be returned to Mecc Alte.

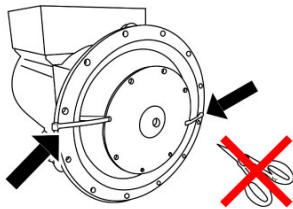

dis_ECO_042-r00

Once the single-bearing alternator is unpacked do not cut the tie strips of the rotor to prevent it from sliding.

4.4 How to dispose of the packing materials

Please recycle the packing materials in accordance with the applicable regulations in the country where the alternator is installed.

4.5 Alternator Movement



Unpacked alternators must always be handled hooking the eyebolts to a lifting device.



For the weight of the alternator see paragraph 2.3.4

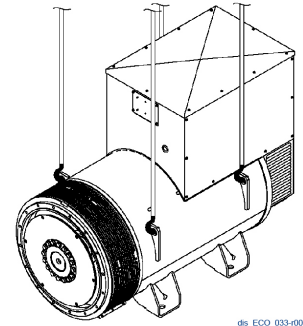

dis_ECO_033-00



Caution

Lift the alternator to a height not exceeding 30 cm.



Do not add any other load. The eyebolts are only designed for the lifting of the alternator. Do not use the alternator eyebolts to lift the fully assembled machine.



Danger

Once it is coupled to the drive motor, to lift the alternator you must follow the instructions provided by the manufacturer of the fully assembled machine.

4.6 Storage

In case of storage, the alternators, be them packed or not, must be stored in a cool, dry place away from vibrations and never exposed to the elements.



The bearings require special maintenance but it is advisable to turn the shaft around once or twice a month to prevent contact corrosion and grease hardening; before startup, where regular lubrication is required, you must also lubricate it.



After being stored for a long time or if there are obvious signs of humidity/condensation, check the insulation state.



Warning

The insulation test must be carried out by a qualified technician.



Warning

Before carrying out the test you must disconnect the voltage regulator.



If the result of the test is too low (less than 1 M Ω) (EN60204-1) you will have to dry the alternator by blowing 50-60 C° pressurized air into the air intakes and exhausts of the alternator.

5 Installation instructions / drive motor coupling

Warning



The final installer is in charge with assembling all the safeguards (disconnect switches, safeguards against direct and indirect contact, safeguards against overcurrent and overvoltage, emergency stop and so on) required to make the machine and the user system comply with the European and International Safety Regulations.



The installation and first startup operations of the fully assembled machine must be carried out by qualified personnel.

Danger



Working alternators are noisy (see paragraph 2.3.3). Install the alternator in insulated rooms and wear earmuffs to operate it.

5.1 Installation Setup



The alternator must be grounded before installation. Please ensure that the grounding system is effective and it complies with the directives of the country where the alternator will be installed.

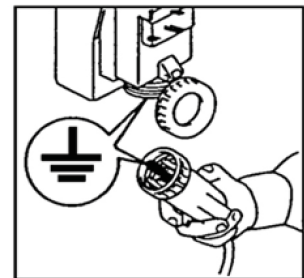

dis_ECO_034-r00

The alternator is designed and built to be installed in well-ventilated environments.



See paragraph 2.4.

Danger



Install the alternator in a ventilated room. Insufficient ventilation may cause overheating and malfunctioning of the alternator.

Please ensure that the base of the alternator and of the drive motor is calculated so as to support the weight of all potential stresses caused by the operation.

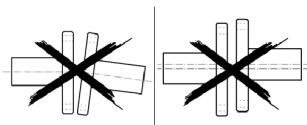

dis_ECO_049-r00

The installer is in charge with correctly coupling the alternator to the drive motor and all the other measures required to guarantee the correct operation of the alternator and to avoid anomalous stresses that might damage the alternator (such as vibrations, misalignments, various kinds of mechanical stresses).

5.2 Unpacking and disposal of packing materials



Danger

Pay attention during all transportation and movement operations.



Danger

Do not stand under suspended loads.



Carefully remove the packing.



Please recycle the packing materials.

5.3 Mechanical coupling

The coupling of the alternator to the drive motor must be carried out by the end user. It is carried out at his sole discretion, but it must:

- Be realized in accordance with the safety regulations in force.
- Ensure the ideal operating conditions for the alternator (air temperature below 40 °C and air vents not blocked).
- Ensure easy access for its verification and maintenance.
- Be assembled on a strong base able to hold the total weight of the alternator and the drive motor.
- Observe the assembly tolerances.

Control the correct fastening of the discs to the alternator rotor.



See paragraph 9.7



Imprecise alignment may cause vibrations and damages to the bearings.

Moreover, it is advisable to check the compatibility of the torsional characteristics of the motor / alternator (to be carried out by the customer).



Please see the related technical documentation.



In case of double-bearing alternators, ensure that the radial loads applied to the shaft protrusion do not exceed the admissible values.



See paragraph 2.3.2.

These values are calculated so as to prevent excessive shaft flexure. The load that may be supported by the bearings is statically and dynamically higher than the one supported by the shaft, however, the presence of excessive vibrations or adverse environmental conditions may reduce the bearing's life or lead to a lower maximum allowable load in proportion to the bearing's life.



During the assembly and disassembly stages of the net, make sure you hold it in position with your hands so as to prevent the elastic net from hitting the operator or anyone else nearby.



In case of single-bearing alternators, during the drive motor coupling stage make sure the rotor does not slip out by keeping the alternator in a horizontal position. Remove the rotor fastening system, if present.

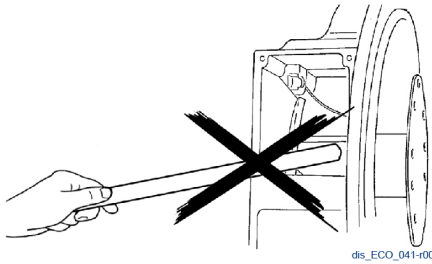

During the mechanical coupling procedures do not use the fan as a lever to turn the rotor.

5.3.1 Alternator Preparation

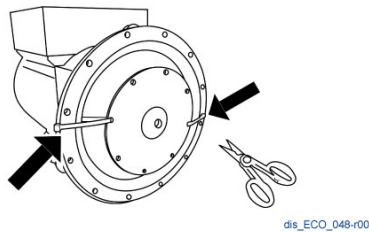

1. In case of single-bearing alternators remove the safety straps from the rotor. After this operation make sure the rotor does not slip out when handling it.
2. Remove the anti rust protective paint from the flange and, if it is a double-bearing alternator, also from the shaft.
3. In case the alternator was stored for more than one year, before startup lubricate the bearings again if they are not sealed (see paragraph 9.4.1).

5.3.2 Aligning the drive motor to the B3B14 alternator

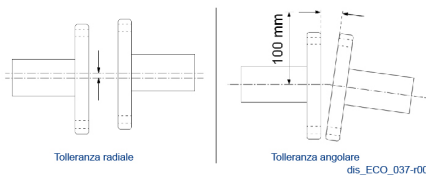

To ensure regular operation of the B3B14 construction type alternator you must align it to the drive motor in observance of the radial and angular tolerances between the two shafts of the drive motor - alternator.



Misalignment may cause damages to the shaft or to the bearing. For alignment tolerances see 2.3.6.

5.3.3 Aligning the drive motor to the MD35 alternator

The (MD35) single-bearing alternator needs a solid flat base in order for the alignment to be realized correctly.

ECO 38 - 40 - 43 - 46

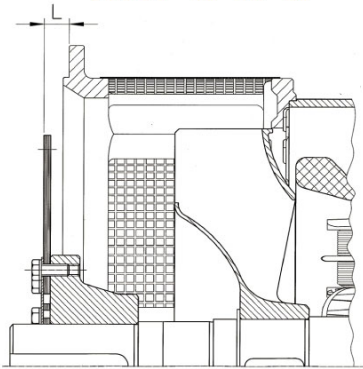

Always check rigorously the accuracy of the L dimension.



Errors on the L dimension may lead to high axial loads on the bearings and potential damages to the drive motor as well.



For alignment tolerances see paragraph 2.3.7.



The presence of flexures on the alternator coupling flange may cause high vibrations and in the worst cases even mechanical breaks.

5.3.4 Thermal Expansion Compensation

The compensation of thermal expansion is particularly important for the single-bearing generators inasmuch as they are connected directly to the motor and a perfect alignment is essential so as to guarantee the intended useful life of the bearings.

In case of double-bearing generators the importance of this aspect depends on the type of motor-generator coupling.

Operating temperatures have a significant impact on the alignment tolerances and must be taken into consideration. Because of them, actually, during the operation, the alternator shaft may be in a different position than its position when powered off.

A compensation of the alignment may therefore be required and it depends on the operating temperatures, on the coupling type, on the distance between the two machines and so on.

The two more important types of thermal expansion to take into consideration are:

- Vertical thermal expansion
- Axial thermal expansion

Vertical thermal expansion

This thermal expansion may cause variations of the radial tolerance value and it may be calculated using the following formula:

$$\Delta H = \alpha \times \Delta T \times H$$

ΔH = Variation of height.

α = Coefficient of thermal expansion (value $\alpha = 10 \times 10^{-6} \text{ K}^{-1}$ may be used).

ΔT = Difference between the alignment temperature and the operating temperature.

H = Axle height.

Axial thermal expansion

The axial thermal expansion value may diminish the axial tolerance between the two shafts.

It is a very important value inasmuch as, when the whole system reaches a uniform temperature, a very narrow non-operating tolerance may lead to an axial force that may burden the bearings damaging them or causing them to break.

The following formula may be used to calculate it:

$$\Delta L = \alpha \times \Delta T \times L$$

ΔL = Variation of the shaft length.

α = Coefficient of thermal expansion (value $\alpha = 10 \times 10^{-6} \text{ K}^{-1}$ may be used).

ΔT = Difference between the alignment temperature and the operating temperature.

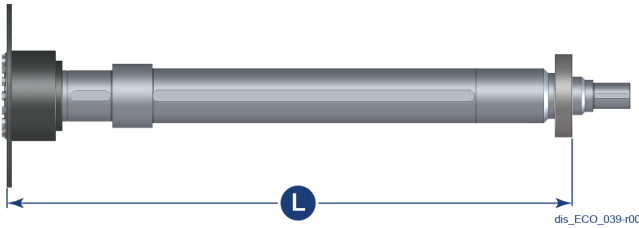

L = Shaft length, calculated between the bearing and the drive motor coupling discs.

The variation of the axial tolerance is calculated by relating the axial thermal expansion of the alternator to that of the motor.

6 Electrical connection



The operation must be carried out by an electrical maintenance technician.

The electrical connection shall be provided by the end user and it is carried out at his sole discretion

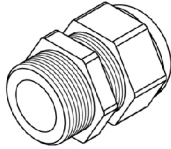

dis_GEN_003-r00

For the entry into the terminal box it is advisable to use cable glands and cable reliefs in compliance with the specifications of the user country.



The jumpers supplied with the 38 series are used in case of rewiring only where indicated.



See "12 terminal connections" table in this chapter.

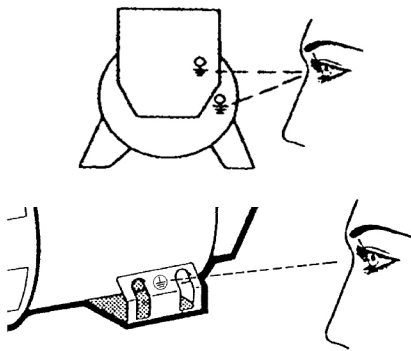

dis_GEN_004-r00

The alternators must always be grounded with a grounding conductor of an appropriate size. Use one of the two dedicated terminals (internal/external).

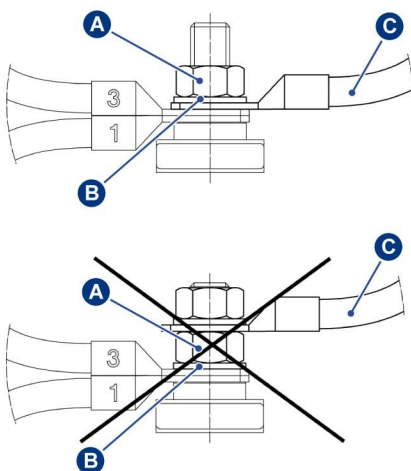

dis_GEN_005-r00

For the electrical connection use adequate cables, sized on the basis of the alternator power. Make the connections to the terminals as shown in the figure.

- A) Hexagon nut
- B) Plain washer
- C) User cable



See paragraph 6.1.

Once the connection was made check the terminal tightening torques that must comply with the instructions given in chapter 9.8

When the connection is finished reassemble the cover of the terminal box.



The user power cables must be wired and supported adequately so as not to cause mechanical stress on the terminal block of the alternator.

Phase rotation and sequence

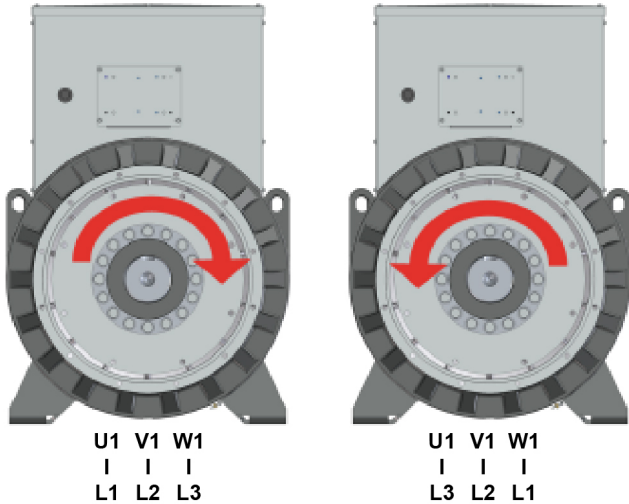

dis_ECO_044-00

All the fans of the ECO alternators are designed to rotate bidirectionally.

Clockwise rotation, seen from the coupling side: the order of the outgoing phases is L1, L2, L3.

Anticlockwise rotation, seen from the coupling side: the order of the outgoing phases is L3, L2, L1 (the order is reversed).

Winding connection modalities

The alternators are manufactured with 12 standard outgoing cables in order to allow different voltage output, for instance, at 50 Hz, 115 V ($\Delta\Delta$) / 200 V (YY) / 230 V (Δ) / 400 V (Y) in the 38 standard series or 230 V ($\Delta\Delta$) / 400 V (YY) / 460 V (Δ) / 800 V (Y) in the 40, 43 and 46 standard series. To pass from a connection to another follow the diagrams shown in the "12 wires connection" table on the next page.

12 wires connection												
Connection		Type 38 winding T0405S3 (***)				Type 40 - 43 - 46 winding T0405P3 (***)						
		50Hz	L - L	380	400	415	440	760	800	830	880	
Series star		50Hz	L - L	380	400	415	440	760	800	830	880	
		50Hz	L - N	220	230	240	254	440	460	480	508	
		60Hz	L - L	460	480	500	530	920	960	1000	1060	
		60Hz	L - N	265	277	290	305	530	554	580	610	
Parallel star		50Hz	L - L	190	200	208	220	380	440	415	440	
		50Hz	L - N	110	115	120	127	220	230	240	254	
		60Hz	L - L	230	240	250	265	460	480	500	530	
		60Hz	L - N	133	138	145	152	265	277	290	305	
Series delta (*)		50Hz	L - L	220	230	240	254	440	460	480	508	
		50Hz	L - M	110	115	120	127	254	265	277	290	
		60Hz	L - L	265	277	290	305	530	554	580	610	
		60Hz	L - M	133	138	145	152	305	317	330	348	
Parallel delta (*)		50Hz	L - L	110	115	120	127	220	230	240	254	
		60Hz	L - L	133	138	145	152	265	277	290	305	
Three phase Zig-Zag (**)		50Hz	L - L	330	346	360	380	660	690	720	760	
		50Hz	L - N	190	200	208	220	380	400	415	440	
		60Hz	L - L	400	415	430	460	790	830	860	915	
		60Hz	L - N	230	240	250	265	460	480	500	530	
Single phase parallel zig-zag (*)		50Hz	L - L	220	230	240	254	440	460	480	508	
		50Hz	L - M	110	115	120	127	254	265	277	290	
		60Hz	L - L	265	277	290	305	530	554	580	610	
		60Hz	L - M	133	138	145	152	305	317	330	348	
Single phase double delta (*)		50Hz	L - L	220	230	240	254	440	460	480	508	
		50Hz	L - M	110	115	120	127	254	265	277	290	
		60Hz	L - L	265	277	290	305	530	554	580	610	
		60Hz	L - M	133	138	145	152	305	317	330	348	

tab_ECO_012-r00



* In case of single-phase loads it is important to remember not to exceed the phase current.

** In the interconnected star connection, the power must be reduced to 0.866 times its nominal value.

*** The highlighted cells represent the nominal values. The other voltage values can be obtained by adjusting the VOLT potentiometer. Voltage variations in relation with the nominal value may though lead to a derating of the machine. For the powers please consult the technical documentation available on www.meccalte.com.



The machine supplied to operate at 50Hz may also work at 60Hz (or vice versa). To obtain the variation you simply adjust the potentiometer to the new nominal voltage value. When passing from 50Hz to 60Hz power may increase by 20% (unvaried current) if the voltage increases by 20%. For alternators specifically built for a 60Hz frequency when passing to 50Hz the voltage and the power must be reduced by 20% in relation to the values referring to 60Hz.

6.1 Terminal board configurations

6.1.1 ECO 38 regulation box and cable connection

SERIES STAR CONNECTION

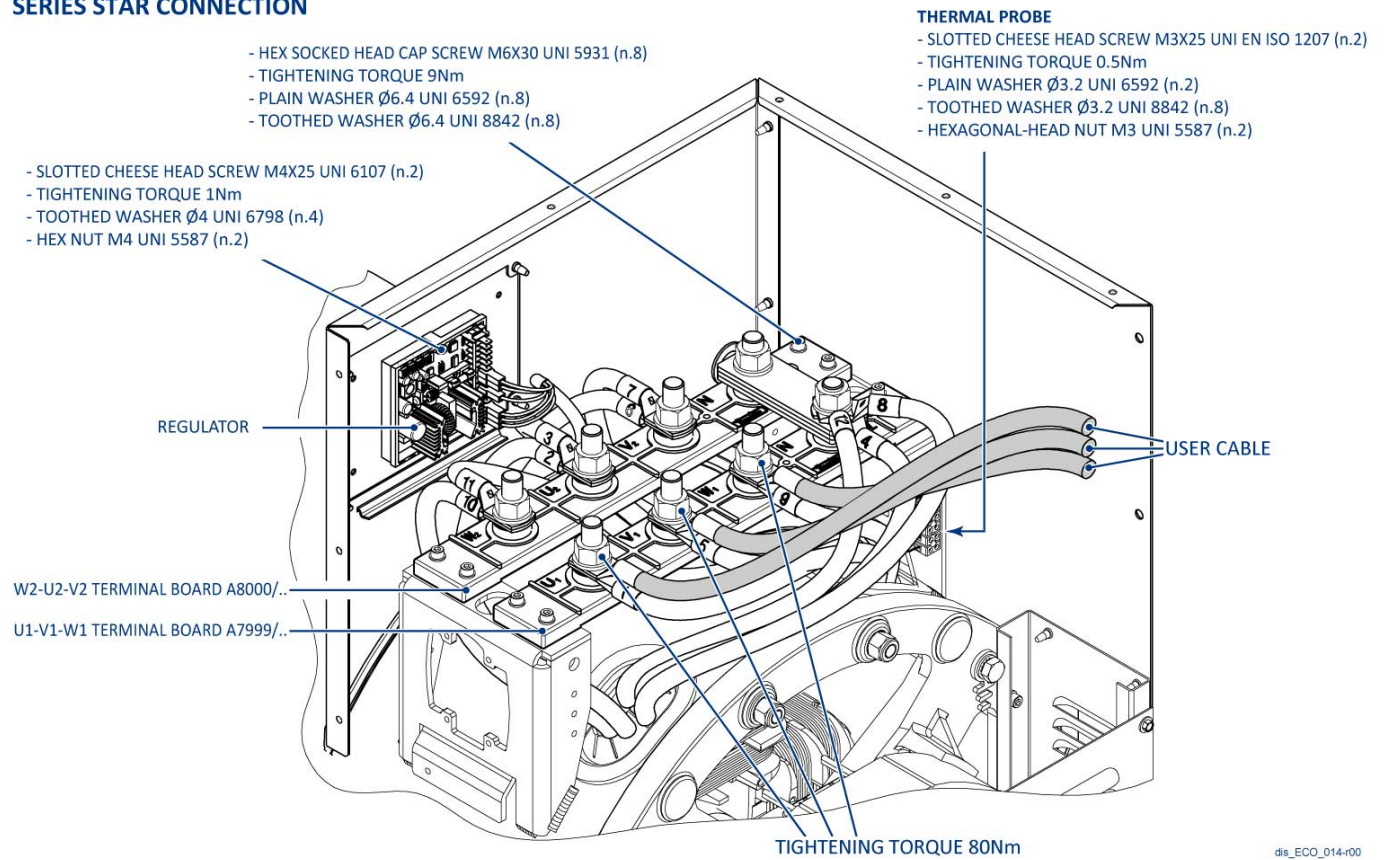

6.1.2 ECO 40 regulation box and cable connection

PARALLEL STAR CONNECTION

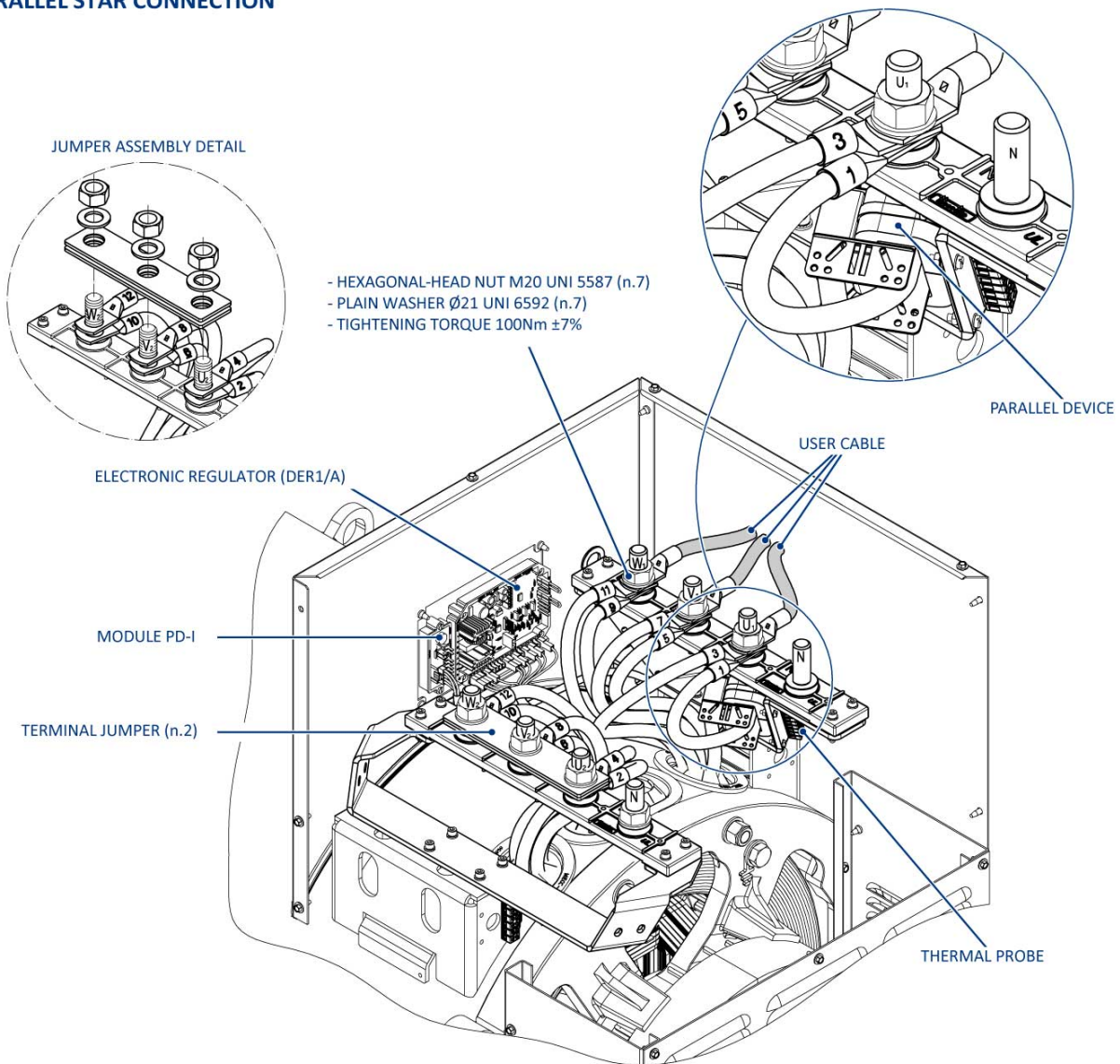

dis_ECO_015-r00

6.1.3 ECO 43 regulation box and cable connection

PARALLEL STAR CONNECTION

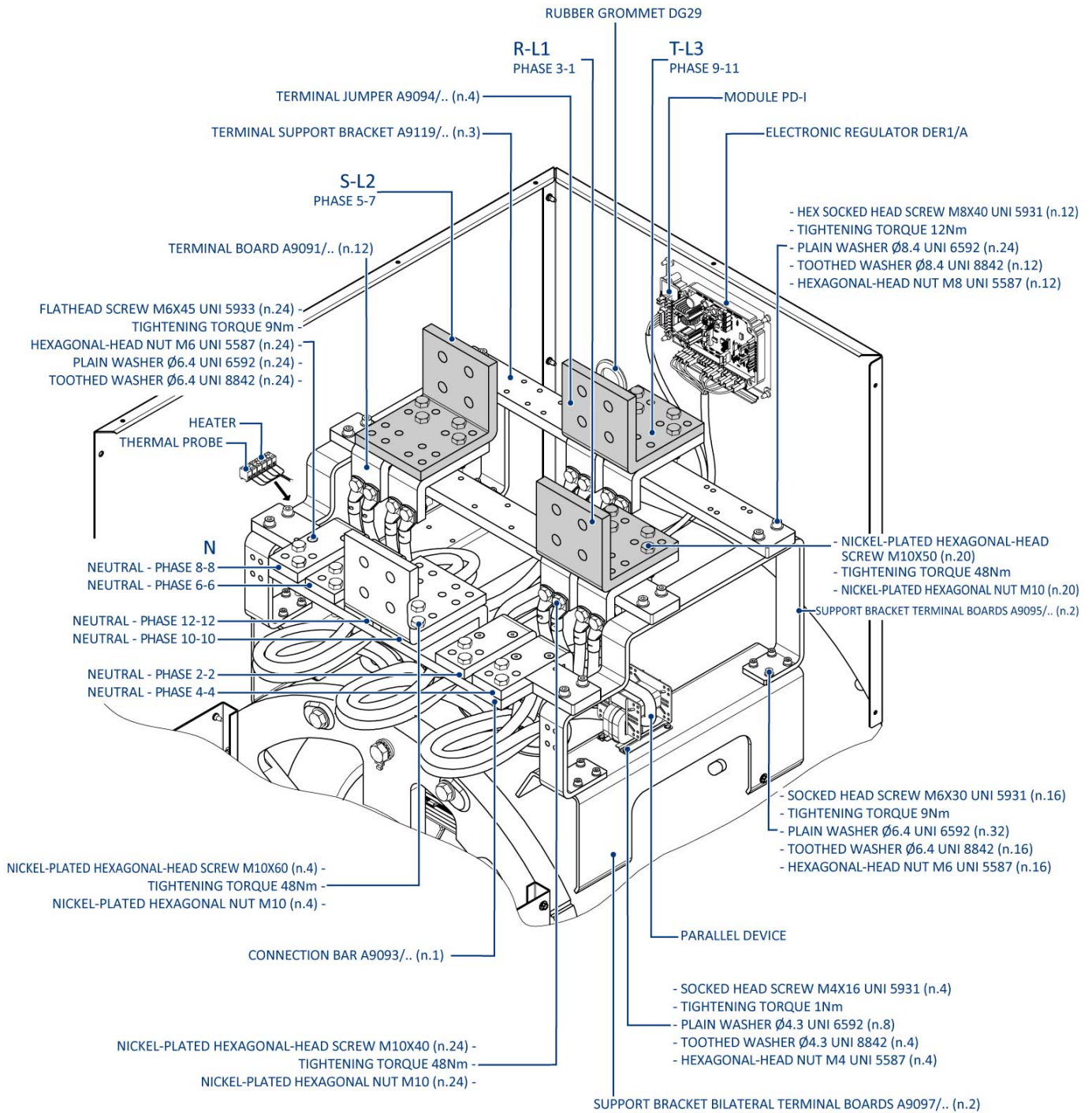

dis_ECO_016-r00

6.1.4 ECO 46 regulation box and cable connection
PARALLEL STAR CONNECTION

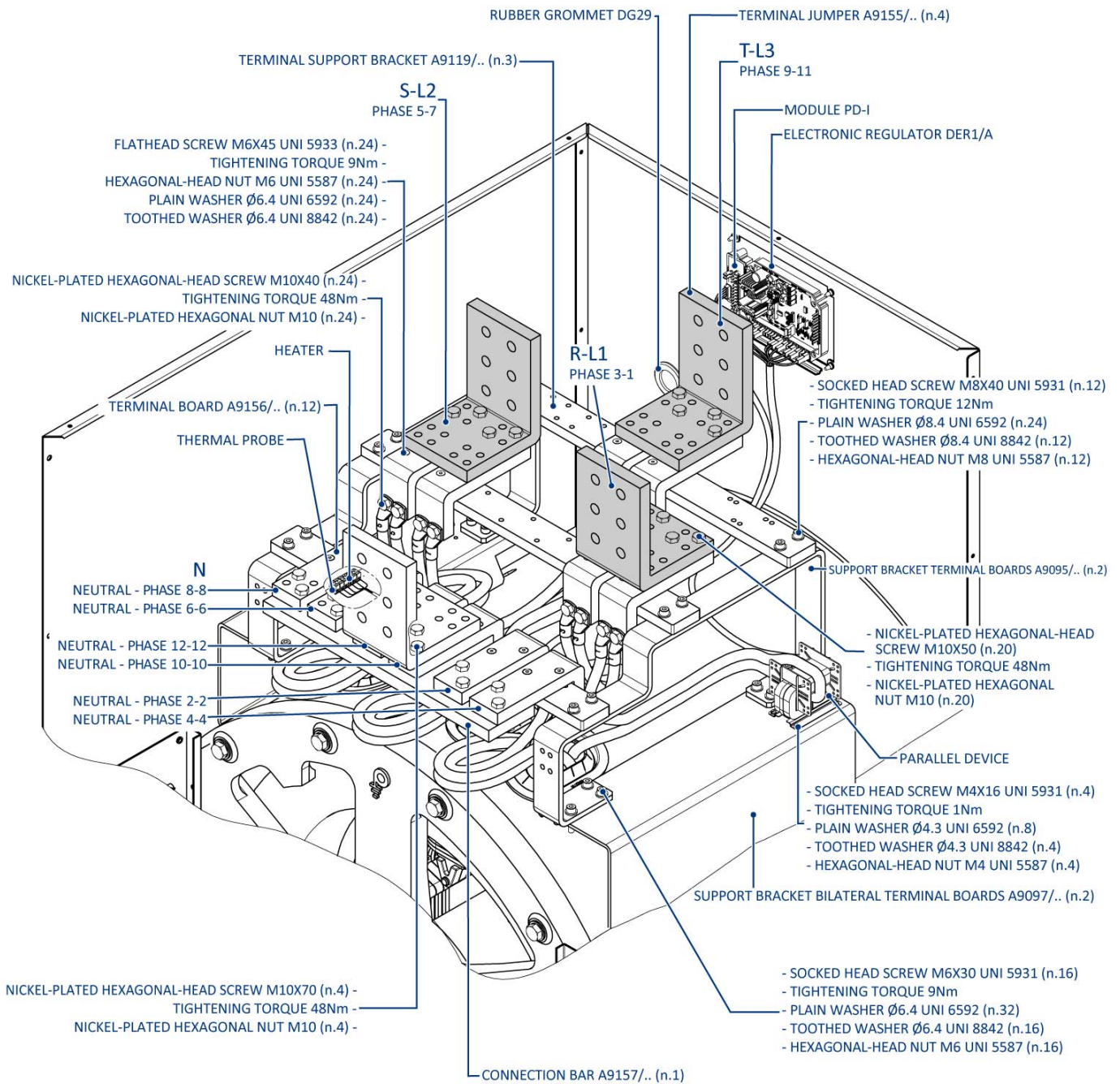

dis_ECO_017-00

6.2 Parallel connection of alternators

In case you want the alternators to operate in parallel you need to use a device to ensure equal droop of output voltages. The parallel transformer is manufactured with a preset voltage drop of 4% at full load when the power factor is 0.

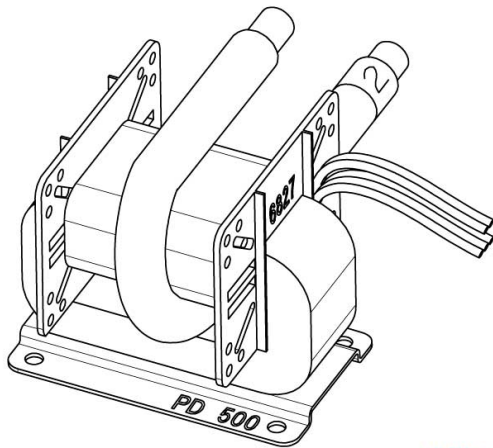

dis_ECO_051-r00

38 Series

The device is supplied on request or it can be assembled by the customer. After having assembled the device you need to check the voltage drop; for further information please refer to the technical guide for parallel operation.

40 - 43 - 46 Series

The device is standard, therefore when two or more alternators of this type must operate in parallel it is enough to just remove the jumper that short-circuits the secondary circuit of the paralleling device.

6.2.1 Installation of a parallel device (series 38)

- Refer to mounting instructions "Retrofitting PD500 Procedure"
- Connect the power coil windings in series with the phase following the instructions

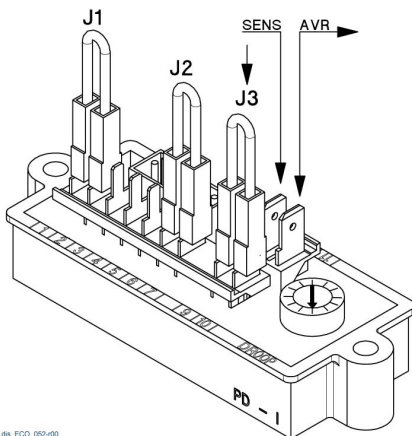

dis_ECO_052-r00



For the number of coil turns needed on the transformer please see the drawing table A9865 inside the procedure

- Once received and installed the parallel device, it is important to check, based on the nominal data of the alternator and the adopted reference type, the jumpers J1 and J2 are wired to the correct fastons, according to drawing table A9865, inside the procedure. Also verify that the droop trimmer on the PD-I is positioned at the center.
- Connect the sensing of the alternator to the PD-I module and connect the PD-I module to the sensing terminal of the regulator, following step by step the instructions on the procedure



See chapter 12.

To enable the paralleling device remove the jumper that short-circuits its secondary winding as shown in the figures beside and in the wiring diagrams.



Warning

For alternators running in parallel to the grid the user must integrate the generation system with adequate protections.



Warning

For these applications it is fundamental to provide protection against the ample excitation variations or an excitation loss relay to avoid serious damages to the alternator.

After having made all the electrical connections and only after having closed the terminal box you may carry out the initial startup test on the system.

Check the no load voltage of the alternator and if necessary act on the electronic regulator VOLT trimmer to move back to the nominal value.

7 Startup Instructions

i This paragraph only reports the instructions for the initial startup of the alternator. You may find further instructions in the manual of the fully assembled machine.



Warning

The startup, operation and stop maneuvers must be carried out by adequately qualified personnel who has read and understood the safety and technical specifications indicated in this manual.



The tools for system startup, operation and stop shall be provided by the installer.



Check the alignment on the fully assembled machine. See paragraph 5.3.2.

- Check the fastening of the machine to the base with the related tightening torques and the robustness of the base.



Check the tightening torques of the terminal connections and their positioning. See paragraph 9.8.

Before the startup of the fully assembled machine you must make sure that:

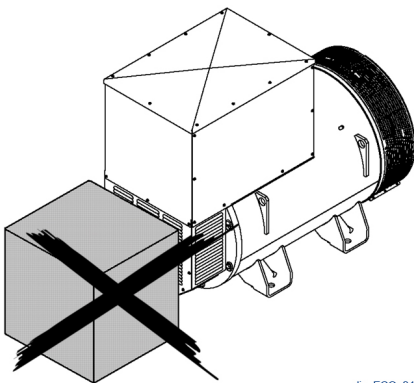

- The cooling air intake and exhaust vents are always unobstructed. For the cooling air volumes required see paragraph 2.3.5.
- The intake side is away from heat sources. However, if not specifically agreed, the temperature of the cooling air must be equal to the room temperature and anyway lower than 40 °C. The alternator may operate at higher temperatures with an appropriate derating.



During the initial startup that must be carried out at lower speed, the installer will have to make sure there are no anomalous noises. In case of anomalous noises stop the system immediately and make adjustments to improve the mechanical coupling.

The rotors of the Mecc Alte alternators and the alternators themselves comply with the regulations (see paragraph 1.5). This means that the vibrations generated by the Mecc Alte alternators are very limited and compliant with the regulations. Potential excessive vibrations are ascribable to the drive motor or to an erroneous motor-alternator coupling and they may cause damages or even breaks to the bearings.



The installer is responsible for following the regulations when assessing and measuring the vibrations on the fully assembled machine (see paragraph 1.5).

After the initial startup

After the initial startup of the fully assembled machine it is necessary to carry out the following verifications:

- Make sure everything works correctly.
- Monitor the vibration level and potential high temperatures of the windings and of the bearings.



In case the alternator, during operation, goes into protection mode for anomalous voltage, troubleshoot the fault before initiating another startup.



See *"Problems, causes and solutions"* chapter 11.

8 Electronic regulators

8.1 DSR Digital Regulator



The operation must be carried out by an electrical maintenance technician.



For further details on the regulators please refer to the specific manual.

Danger



Check with the alternator on.

Carefully perform the test, use adequate PPE such as for instance insulating gloves.



Voltage testing is performed off-load with the alternator running at nominal frequency. To obtain voltage regulation use the VOLT potentiometer of the electronic regulator.

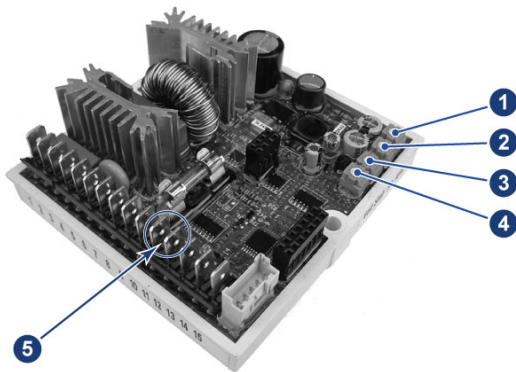

dis_ECO_019-r00

1. Regulation of overload protection (AMP).
2. Regulation of low frequency protection (Hz).
3. Regulation of stability (STAB).
4. Regulation of voltage (VOLT).
5. Terminals 10 and 11 for remote regulation of voltage.

Self-regulation is achieved through the DSR digital regulator that guarantees, under static conditions, a $\pm 1\%$ voltage accuracy with any power factor and with a speed variation ranging from -5% to $+20\%$.

Remote Regulation

To achieve remote regulation insert a $10K\Omega$ potentiometer in the dedicated terminals 10-11.

8.1.1 Stability Adjustment

The alternators are part of a system that can be outlined as a motor + alternator. The alternator may therefore exhibit instabilities of the rotation regime and of the voltage due to the irregular operation of the motor it is connected to.

There is a potentiometer dedicated to the adjustment of this stability (STAB potentiometer), because the alternator voltage and motor speed regulation systems may go into conflict, causing both speed and voltage oscillations.

It is important to stress that Mecc Alte's alternators are tested using an electric motor, not a heat engine. Therefore, STAB adjustment is set correctly for the alternator driven by an electric motor.

General instructions to follow in case of instability problems:

1. Check the STAB potentiometer setting and make sure it corresponds to the settings reported in the tables below.
2. If there is no correspondence, reset the potentiometer to the value indicated in the table below; in case of missing information position in the middle.
3. If the problem persists, rotate the potentiometer anticlockwise a notch and repeat the test.
4. If no differences are noticed or the differences are minimal, rotate another notch anticlockwise; continue this procedure until the problem is solved.
5. If by rotating the potentiometer anticlockwise, the voltage instability increases, set the potentiometer as indicated at point 2. Rotate the potentiometer clockwise a notch and repeat the test
6. If there are no changes or they are minimal, rotate another notch clockwise and repeat the test.
7. Continue this procedure until the problem is solved.
8. If after these steps the problem is still not solved, you may need to adjust the stability (gain) of the motor speed regulation system. If this does not solve the problem either, try to change the stability software parameters of the voltage regulator. See the dedicated manual.

DSR STAB TRIMMER					
Alternator		Nominal frequency = 50 Hz		Nominal frequency = 60 Hz	
Model	Pole	S [kVA]	STAB Position [tag]	S [kVA]	STAB Position [tag]
ECO38-1S/4 A (*)	4	180	9	216	6 1/2
ECO38-2S/4 A (*)	4	200	9	240	8
ECO38-3S/4 A (*)	4	225	8 1/2	270	7 1/2
ECO38-1L/4 A (*)	4	250	8 1/2	300	8
ECO38-2L/4 A (*)	4	300	8	360	11
ECO38-3L/4 A (*)	4	350	11	420	9 1/2
ECO40-1S/4 B (**)	4	400	9	480	7
ECO40-2S/4 B (**)	4	450	8 1/2	540	8
ECO40-3S/4 B (**)	4	500	9	600	8 1/2
ECO40-1L/4 B (**)	4	550	9	660	8 1/2
ECO40-1.5L/4 B (**)	4	620	9	744	
ECO40-2L/4 B (**)	4	680	9 1/2	816	7
ECO40-VL/4 B (**)	4	750	9	900	7 1/2
ECO43-1S/4 A (**)	4	800	9	960	7 1/2
ECO43-2S/4 A (**)	4	930	9	1116	8
ECO43 1M/4 A (**)	4	1025		1230	
ECO43 2M/4 A (**)	4	1150		1380	
ECO43-2L/4 A (**)	4	1300	9 1/2	1560	8
ECO43-VL/4 A (**)	4	1400	9 1/2	1700	8
ECO46-1S/4 A (**)	4	1500	8	1800	6 1/2
ECO46-1.5S/4 A (**)	4	1650	9	1980	8 1/2
ECO46-2S/4 A (**)	4	1800	8 1/2	2160	8
ECO46-1L/4 A (**)	4	2100	11	2520	9
ECO46-1.5L/4 A (**)	4	2300	9	2760	9
ECO46-2L/4 A (**)	4	2500	9 1/2	3000	9
ECO46 VL4 A (**)	4	2800		3360	

tab_ECO_007-r00

* DSR: P[11] = 4, P[12] = 3, P[13] = 16384, quadratic function with integral gain.

** DSR/A: P[11] = 5, P[12] = 1, P[13] = 26624, linear function with integral gain

8.1.2 Protections

To avoid anomalous and dangerous operation of the alternator, the DSR digital regulator is equipped with a low speed protection and an overload protection.

Low speed protection

Its intervention is instantaneous and it causes the reduction of the alternator voltage when the frequency drops by 4 ± 1 % under the nominal frequency.

The intervention threshold is set using the "Hz" potentiometer.

Overload protection

A dedicated circuit compares the partialized excitation voltage. If the preset value for this voltage (a value corresponding with a load current value equal to 1.1 times the current indicated on the alternator tag) is exceeded for more than 20 seconds, the regulator steps in lowering the alternator voltage and subsequently limiting the current within a safe value range.

The delay is expressly introduced to allow the motors that normally start in 5÷10 seconds to pick-up. This intervention threshold may be adjusted using the "AMP" potentiometer.

Causes that lead to protection intervention.

Instantaneous protection intervention for low speed	1 - Speed reduced by 4 ± 1 % as compared to the rated data.
Delayed protection intervention for overload	2 - Overload of 10% as compared to the rated data.
	3 - Power factor ($\cos \phi$) lower than the rated data.
	4 - Environmental temperature above 50°C.
Intervention of both protections	5 - Combination of factor 1 and factors 2, 3, 4.

In case both protections intervene, the voltage supplied by the alternator will drop to a value that depends on the size of the fault.

Voltage will be automatically restored to its nominal value when the fault is solved.

8.1.3 Inputs and Outputs: technical specifications

TABLE 1 CONNECTOR CN 1				
Term.(*)	Name	Function	Specifications	Notes
1	Exc-	Excitation	Continuous Rating: 5 Adc max Transitory Rating: 12 Adc at peak	
2	Aux / Exc+			
3	Aux / Exc+	Power	Frequency: from 12Hz to 72Hz Range: 40 Vac - 270 Vac	
9	Aux / Neutral			
4	F_Phase	Sensing	Range: 140 Vac - 280 Vac Burden: <1VA	Measurement of average value (rectified) or actual effective value for voltage adjustment
5	F_Phase			
6	H_Phase		Range: 70 Vac - 140 Vac Burden: <1VA	
7	H_Phase			
8	Aux / Neutral			
10	Vext / Pext	Input for remote voltage control	Type: Not insulated Range: 0 - 2,5 Vdc or 10 K Potentiometer Adjustment: from - 14% to + 14% (***) Burden: 0-2 mA (sink) Max length: 30m (**)	Tolerates voltages from -5V to +5V but for values exceeding the range it is automatically disabled
11	Common			
12	50 / 60 Hz	50/60Hz Jumper input	Type: Not insulated Max length: 3m	Selection of underspeed protection threshold 50x(100%-αHz%) or 60x(100%-αHz%) αHz% is the position relative to the Hz trimmer or the percentage value of parameter 21
13	Common			
14	A.P.O.	Active protections output	Type: Non-insulated open collector Current: 100 mA Voltage: 30V Max length: 30m (**)	Active level (****), activating alarm and delay time programmable
15	Common			

tab_ECO_008-r00

* They are connected together on the board the following terminals: 2 and 3; 4 and 5; 6 and 7; 8 and 9; 11 and 13 and 15.

** With an external EMI SDR 128/K filter (3m without EMI filter).

*** Starting from version 10 of the Firmware. It is important not to exceed by more than ± 10%.

**** Starting from rev. 18 of the Firmware.



The regulators mounted on board the alternators prove to be calibrated during the final test. For loose regulators (for instance spare parts) or if wiring or calibration variations are required, you will have to perform an adequate setting of the regulator to guarantee its correct operation.

The basic settings may be performed directly on the regulator through the 4 trimmers (VOLT - STAB - Hz - AMP), the 50/60 jumper and the Vext input.

More detailed settings and measures may be performed only via software using, for instance, the Mecc Alte USB2DxR communication interface and the DxR_Terminal software.

Vext Input

The Vext input (connector CN1 terminals 10 and 11) allows the analog remote control of the output voltage through a 10Kohm potentiometer with a variation range that may be programmed via parameter 16 (by default the setting is ± 14% starting from version 10 of the Firmware) in relation to the value set by the VOLT trimmer or by parameter 19.

If you want to use continuous voltage, it will have an effect if contained within the range from 0V to +2,5V.

The input tolerates voltages from -5V to + 5V, but for values exceeding the 0V / +2.5V limits (or in case of disconnection) there are two available options:

- Not to consider the value (default configuration) and go back to the regulation of the voltage value set through the trimmer (if enabled) or through parameter 19.
- Maintain the minimum (or the maximum) reachable voltage value.

The two options can be set through the RAM Voltage CTRL flag in the Configuration Menu corresponding to the B7 bit of the configuration word P[10].



The continuous voltage supply must be able to absorb at least 2 mA.

In the regulation it is advisable not to exceed by more than $\pm 10\%$ the nominal voltage value of the alternator.

50/60 Signal

A jumper placed on the 50/60 input (connector CN1 terminals 12 and 13) entails the switching of the low speed protection threshold from $50 \cdot (100\% - \alpha Hz\%)$ to $60 \cdot (100\% - \alpha Hz\%)$, where $\alpha Hz\%$ is the related position of the HZ trimmer.

APO Contact

Acronym for Active Protection Output: (connector CN1 terminals 14 and 15) uninsulated open collector 30V-100mA transistor, by default normally closed (starting from revision 18 of the firmware; for firmware revisions up to 17 the transistor is normally open and it closes in case of an active alarm). It opens (with a software programmable delay of 1 to 15 seconds) when, one or several alarms, that may be selected separately via software, are active.

VOLT Trimmer

It allows regulation from approximately 70V to approximately 140V when terminals 4 and 5 are used for the sensing or from approximately 140V to approximately 280V when terminals 6 and 7 are used.

STAB Trimmer

It regulates the dynamic response (droop) of the alternator under transient conditions.

MP Trimmer

It regulates the excitation overcurrent protection intervention threshold.

To calibrate the overload protection, perform the following procedure:

1. Rotate the Hz trimmer anticlockwise.
2. Apply nominal load to the alternator.
3. Reduce the speed by 10%.
4. Rotate the AMP trimmer completely in anticlockwise direction.
5. After a few seconds you should notice a reduction of the alternator voltage value and the activation of alarm 5 (indicated by a change in the LED flashing).
6. In this case slowly rotate the "AMP" trimmer in clockwise direction until you get the output voltage value to 97% of its nominal value: alarm 5 is still active.
7. If you go back to nominal speed, alarm 5 disappears after a few seconds and the alternator voltage rises back to the nominal value.
8. Readjust the Hz trimmer as indicated.

Hz Trimmer

It allows the regulation of the low speed protection intervention threshold up to -20% compared to the nominal speed value set by the 50/60 jumper (at 50 Hz the threshold may be adjusted from 40Hz to 50Hz, to 60 Hz the threshold may be adjusted from 48Hz to 60Hz).

The intervention of the protection diminishes the alternator voltage. Perform the adjustment as follows:

1. Rotate the Hz trimmer anticlockwise.
2. If the machine must operate at 60 Hz, make sure the jumper between terminals 12 and 13 of the CN1 connector is inserted.
3. Take the alternator to a speed equal to 96% of its nominal speed.
4. Slowly turn the "Hz" trimmer. Rotate it in clockwise direction until the alternator voltage starts to diminish and at the same time make sure the LED starts blinking fast.
5. By increasing the speed, the voltage of the generator should go back to normal and alarm should disappear.
6. Take the speed back to the nominal value.



Even if still continuing to regulate the voltage, the DSR goes into switch-off mode when the frequency decreases under 20 Hz. To restore it you need to shut down the alternator completely.

Alarm management



See paragraph 10.1.

Electrical diagrams



See paragraph 12.1.

8.2 DER1 Digital Regulator



The operation must be carried out by an electrical maintenance technician.



For further details on the regulators please refer to the specific manual.

Danger



Check with the alternator on.

Carefully perform the test, use adequate PPE such as for instance insulating gloves.



Voltage testing is performed off-load with the alternator running at nominal frequency. To obtain the voltage regulation use the VOLT potentiometer of the electronic regulator.

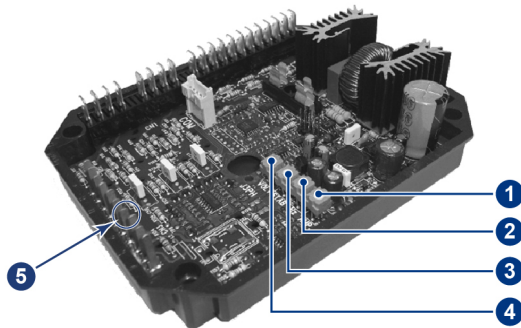

1. Regulation of the overload protection (AMP).
2. Adjustment of low frequency protection (Hz).
3. Adjustment of stability (STAB).
4. Adjustment of voltage (VOLT).
5. Terminals 29 and 30 for remote regulation of voltage.

dis_ECO_020-00

The self-regulation achieved through the DER1 digital regulator guarantees, under static conditions, a $\pm 1\%$ voltage accuracy with any power factor and with a speed variation ranging from -5% to $+20\%$.

Remote Regulation

To obtain a regulation within $\pm 14\%$ of the nominal value insert a $100\text{K}\Omega$ potentiometer in the dedicated terminals 29-30.

To obtain a regulation within $\pm 7\%$ of the nominal value insert a $25\text{K}\Omega$ linear potentiometer in series with a $3.9\text{K}\Omega$ resistor to halve the effect of the external potentiometer.

DER2 Digital Regulator

The DER2 regulator is assembled as a normal DER1 except for the USB2DxR communication interface that is substituted by the new $1\text{X}5$ p.2.54 mm strip connector that is mounted directly on the card. The alternators being equal, the DER2 regulator settings are the same as DER1.

8.2.1 Stability Adjustment

The alternators are part of a system that can be outlined as a motor + alternator. The alternator may therefore exhibit instabilities of the rotation regime and of the voltage due to the irregular operation of the motor it is connected to.

There is a potentiometer dedicated to the adjustment of this stability (STAB potentiometer), because the alternator voltage and motor speed regulation systems may go into conflict, causing both speed and voltage oscillations.

It is important to stress that Mecc Alte's alternators are testes using an electrical, and not a heat engine. Therefore, STAB adjustment is set correctly for the alternator driven by an electric motor.

General instructions to follow in case of instability problems:

1. Check the STAB potentiometer setting and make sure it corresponds to the settings reported in the tables below.
2. If there is no correspondence, reset the potentiometer to the value indicated in the table below; in case of missing information position in the middle.
3. If the problem persists, rotate the potentiometer anticlockwise a notch and repeat the test.
4. If no differences are noticed or the differences are minimal, rotate another notch anticlockwise; continue this procedure until the problem is solved.
5. If by rotating the potentiometer anticlockwise, the voltage instability increases, set the potentiometer as indicated at point 2. Rotate the potentiometer clockwise a notch and repeat the test
6. If there are no changes or they are minimal, rotate another notch clockwise and repeat the test.
7. Continue this procedure until the problem is solved.
8. If after these steps the problem is still not solved, you may need to adjust the stability (gain) of the motor speed regulation system. If this does not solve the problem either, try to change the stability software parameters of the voltage regulator. See the dedicated manual.

DER1 STAB TRIMMER							
Alternator		Nominal frequency = 50 Hz			Nominal frequency = 60 Hz		
Model	Pole	S [kVA]	STAB Position [tag]		S [kVA]	STAB Position [tag]	
			Single Phase	Three Phase		Single Phase	Three Phase
ECO38-1S/4 A (*)	4	180		6	216		
ECO38-2S/4 A (*)	4	200		8	240		8
ECO38-3S/4 A (*)	4	225		8 1/2	270		8
ECO38-1L/4 A (*)	4	250			300		
ECO38-2L/4 A (*)	4	300		8	360		
ECO38-3L/4 A (*)	4	350	11	9	420	8 1/2	9
ECO40-1S/4 B (**)	4	400	11	9	480		
ECO40-2S/4 B (**)	4	450	11	8 1/2	540		
ECO40-3S/4 B (**)	4	500	9 1/2	9	600		
ECO40-1L/4 B (**)	4	550	9		660	8 1/2	
ECO40-1.5L/4 B (**)	4	620	9	9 1/2	744		9
ECO40-2L/4 B (**)	4	680	11		816		
ECO40-VL/4 B (**)	4	750	9 1/2		900	9	
ECO43-1S/4 A (**)	4	800	9		960	8 1/2	
ECO43-2S/4 A (**)	4	930	9		1116	8 1/2	
ECO43 1M/4 A (***)	4	1025	7	7	1230	6	
ECO43 2M/4 A (**)	4	1150	9 1/2	9	1380	9	
ECO43-2L/4 A (**)	4	1300	9		1560	8	
ECO43-VL/4 A (**)	4	1400	9		1700		
ECO46-1S/4 A (**)	4	1500	8		1800		
ECO46-1.5S/4 A (**)	4	1650	9 1/2	9 1/2	1980		9
ECO46-2S/4 A (**)	4	1800	11	9 1/2	2160	9 1/2	9
ECO46-1L/4 A (**)	4	2100	9 1/2		2520	8 1/2	
ECO46-1.5L/4 A (**)	4	2300	11	9	2760		8 1/2
ECO46-2L/4 A (**)	4	2500	9		3000		
ECO46 VL4 A (**)	4	2800	9		3360		

tab_ECO_009-r00

* DER 1: P[11] = 4, P[12] = 3, P[13] = 16384, quadratic function with integral gain.

** DER 1/A: P[11] = 5, P[12] = 1, P[13] = 26624, linear function with integral gain

*** DER 1/A: P[11] = 7, P[12] = 1, P[13] = 26624, linear function with integral gain

8.2.2 Protections

To avoid anomalous and dangerous operation of the alternator, the DER1 digital regulator is equipped with a low speed protection and an overload protection.

Low speed protection

Its intervention is instantaneous and it causes the reduction of the alternator voltage when the frequency drops by 4 ± 1 % under the nominal frequency.

The intervention threshold is set using the "Hz" potentiometer.

Overload protection

A dedicated circuit compares the partialized excitation voltage. If the preset value for this voltage (a value corresponding with a load current value equal to 1.1 times the current indicated on the alternator tag) is exceeded for more than 20 seconds, the regulator steps in lowering the alternator voltage and subsequently limiting the current within a safe value range.

The delay is expressly introduced to allow the motors that normally start in 5÷10 seconds to pick-up. This intervention threshold may be adjusted using the "AMP" potentiometer.

Causes that lead to protection intervention.

Instantaneous protection intervention for low speed	1 - Speed reduced by 4 ± 1 % as compared to the rated data.
Delayed protection intervention for overload	2 - Overload of 10% as compared to the rated data.
	3 - Power factor ($\cos \phi$) lower than the rated data.
	4 - Environmental temperature above 50°C.
Intervention of both protections	5 - Combination of factor 1 and factors 2, 3, 4.

In case both protections intervene, the voltage supplied by the alternator will drop to a value that depends on the size of the fault.

Voltage will be automatically restored to its nominal value when the fault is solved.

8.2.3 Inputs and Outputs: technical specifications

TABLE 1 CONNECTOR CN 1				
Term. (*)	Name	Function	Specification	Notes
1	Exc-	Excitation	Continuous Rating: 5 Adc Transitory Rating: 12 Adc at peak	
2	Aux / Exc+			
3	Aux / Exc+	Power	40 ÷ 270 Vac Frequency 12 ÷ 72Hz (**)	(*)
4	UFG	Sensing Range 2	Range 2: 150 ÷ 300 Vac Burden: < 1VA	U channel
5	UFG			
6	UHG	Sensing Range 1	Range 1: 75 ÷ 150 Vac Burden: < 1VA	
7	UHG			
8	UHB	Jumper Range 1		Short for sensing 75 ÷ 150 Vac
9	UFB			
10	UFB			Star point of YY or Y connection, in common with board feeding (*)
11	UFB	Board reference		
12	UFB			
13	/		Not present	
14	VFG	Sensing	Range 1: 75 ÷ 150 Vac Burden: < 1VA	V channel, to be connected in parallel to U channel in case of single phase sensing
15	VHG	Sensing Range 1		
16	VHB		Range 2: 150 ÷ 300 Vac Burden: < 1VA	
17	VFB	Range 2		
18	/		Not present	
19	WFG	Sensing	Range 1: 75 ÷ 150 Vac Burden: < 1VA	W channel, unused (with shorted inputs) in case of single phase sensing
20	WHG	Sensing Range 1		
21	WHB		Range 2: 150 ÷ 300 Vac Burden: < 1VA	
22	WFB	Range 2		

tab_ECO_010-r00

* They are connected together on the board the following terminals: 2 and 3; 4 and 5; 6 and 7; 9 and 10, 11 and 12.

** Minimum supply voltage 40Vac at 15Hz, 100V at 50Hz, 115V at 60Hz.

TABLE 2 CONNECTOR CN 3				
Term. (*)	Name	Function	Specifications	Notes
23	Common	Active protections output	Type: Non-insulated open collector Current: 100 mA Voltage: 30 V Max length: 30m (***)	Active level(*****), activating alarm and delay time programmable
24	A.P.O.			
25	Common	Jumper 50/60 Hz	Type: Not insulated Max length: 3m	Selection of underspeed protection threshold
26	50/60 Hz			
27	0EXT	Jumper for remote voltage control 0÷2,5 Vdc	Type: Not insulated Max length: 3m	Short for 0÷2,5Vdc input or potentiometer
28	JP1			
29	0EXT	Input for remote voltage	Type: Not insulated Max length: 30m (***)	Regulation: ± 10% (*****)
30	PEXT	Input for remote voltage control 0÷2,5 Vdc or Pext	Input: 0÷2,5 Vdc or 100K Potentiometer	Burden: 0÷1mA (sink)
31	JP2	Pext jumper	Type: Not insulated Max length: 3m	Short for 0÷2,5Vdc input or potentiometer
32	± 10 V	control ± 10 Vdc	Input: ± 10 Vdc	Burden: ± 1mA (source/sink)

tab_ECO_011-r00

*** With an external EMI filter (3m without the EMI filter).

**** 50·(100%-αHz%) or 60·(100%-αHz%) where αHz% is the position in relation to the Hz trimmer or the percentage value of the P[21] parameter.

***** Values not to be exceeded, the actual range depends on the P[16] parameter.

***** Starting from rev. 18 of the firmware.



The regulators mounted on board the alternators prove to be calibrated during the final test. For loose regulators (for instance spare parts) or if wiring or calibration variations are required, you will have to perform an adequate setting of the regulator to guarantee its correct operation.

The basic settings may be performed directly on the regulator through the 4 trimmers (VOLT - STAB - Hz - AMP), the 50/60 jumper, JP1, JP2 and the Pext input.

More detailed settings and measures may be performed only via software using, for instance, the Mecc Alte USB2DxR communication interface and the DxR_Terminal software.

Remote control of voltage

The Pext inputs (terminal 30) and $\pm 10V$ (terminal 32) allow the analog remote control of the output voltage through a continuous voltage or a potentiometer, with a programmable variation range with respect to the value set through the trimmer (by default) or through the P[19] parameter.



Figura 1: senza saturazione della tensione di uscita al raggiungimento dei limiti della tensione di ingresso.



Figura 2: con saturazione della tensione di uscita al raggiungimento dei limiti della tensione di ingresso.

If you want to use a continuous voltage it will have an effect if contained within the 0Vdc/2,5Vdc o -10Vdc/+10Vdc range, if connected respectively between the terminals 30 and 29, or 32 and 29 and based on the presence or absence of the JP1 and JP2 jumpers.

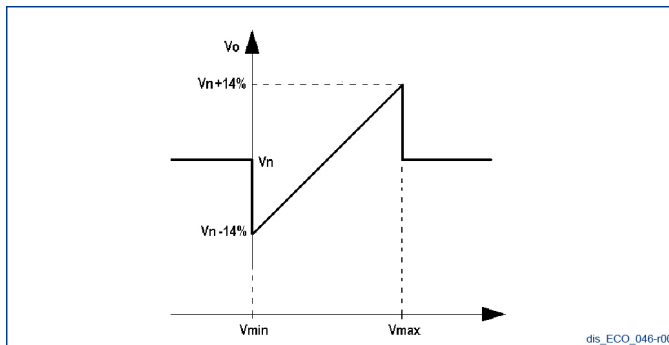
For values that exceed the above-mentioned limits (or in case of disconnection) you have two available options:

- Not to consider the value and go back to the regulation of the voltage value set through the trimmer (if enabled) or through parameter P[19], fig. 1.
- Maintain the minimum (or the maximum) reachable voltage value, fig. 2.

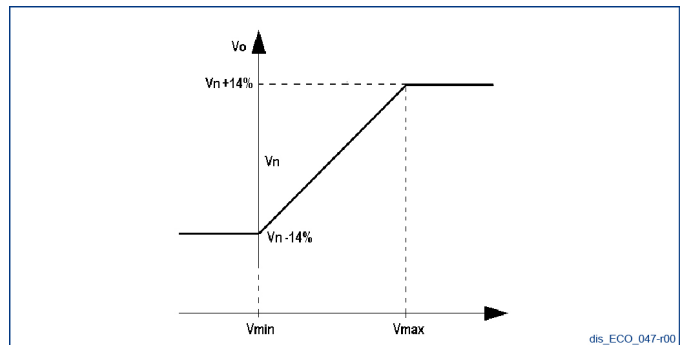
The second option can be set through the RAM Voltage CTRL flag in the Configuration Menu corresponding to the B7 bit of the configuration word P[10].



See the technical guide: DER 1 Digital Regulator.



The continuous voltage supply must be able to absorb at least 2 mA.

In the regulation it is advisable not to exceed by more than $\pm 10\%$ the nominal voltage value of the alternator.

50/60 Signal

A jumper placed on the 50/60 input (terminals 25 and 26) entails the switching of the low speed protection threshold from 50-(100- α Hz%) to 60-(100- α Hz%), where α Hz% is the related position of the HZ trimmer.

APO Contact

Acronym for Active Protection Output: (connector CN3 terminals 23 and 24) uninsulated open collector 30V-100mA transistor, by default normally closed (starting from revision 19 of the firmware; for firmware revisions up to 18 the transistor is normally open and it closes in case of an active alarm). It opens (with a software programmable delay of 1 to 15 seconds) when, one or several alarms, that may be selected separately via software, are active.

VOLT Trimmer

It allows regulation from approximately 75V to approximately 150V when terminals 6/7 - 10/11/12 (with an 8-9 jumper) 15-16 and 20-21 are used for the sensing or from approximately 150V to approximately 300V when terminals 4/5 - 9/10/11/12, 14-17 and 19-22 are used.

STAB Trimmer

It regulates the dynamic response (droop) of the alternator under transient conditions.
It must not be rotated to minus two notches counted in clockwise direction.

MP Trimmer

It regulates the excitation overcurrent protection intervention threshold.
To calibrate the overload protection, perform the following procedure:

1. Rotate the AMP trimmer completely in clockwise direction.
2. Feed the alternator an overload having $\cos \phi = 0.8$ or $\cos \phi = 0$ respectively equal to 125% or 110% of the nominal load.
3. After two minutes slowly turn the AMP trimmer anti-clockwise until you get a reduction of the generator's voltage value and the activation of alarm 5 (visible through a change in the LED flashing)
4. Adjust the AMP trimmer so as to get an output voltage value of 97% of the nominal value: alarm 5 is still active
5. If the load is removed, alarm 5 disappears after a few seconds and the generator voltage goes back to the nominal value.

Hz Trimmer

It allows the regulation of the low speed protection intervention threshold up to -20% compared to the nominal speed value set by the 50/60 jumper (at 50 Hz the threshold may be adjusted from 40Hz to 50Hz, to 60 Hz the threshold may be adjusted from 48Hz to 60Hz).

The intervention of the protection diminishes the alternator voltage. Perform the adjustment as follows:

1. Rotate the Hz trimmer anticlockwise.
2. If the machine must operate at 60 Hz, make sure the jumper between terminals 25 and 26 is inserted.
3. Take the alternator to a speed equal to 96% of its nominal speed.
4. Slowly regulate the "Hz" trimmer. Rotate it in clockwise direction until the alternator voltage starts to diminish and at the same time make sure the LED starts blinking fast.
5. By increasing the speed, the voltage of the generator should go back to normal and alarm should disappear.
6. Take the speed back to the nominal value.



Even if still continuing to regulate the voltage, the DER1 goes into switch-off mode when the frequency decreases under 20 Hz. To restore it you need to shut down the alternator completely.

Alarm management



See paragraph 10.2.

Electrical diagrams



See paragraph 12.2.

8.3 UVR6-SR7 analog regulators



The operation must be carried out by an electrical maintenance technician.



For further details on the regulators please refer to the specific manual.

Danger



Check with the alternator on.

Carefully perform the test, use adequate PPE such as for instance insulating gloves.



Voltage testing is performed off-load with the alternator running at nominal frequency. To obtain the regulation of voltage within $\pm 5\%$ of the nominal value turn the voltage potentiometer of the electronic regulator.

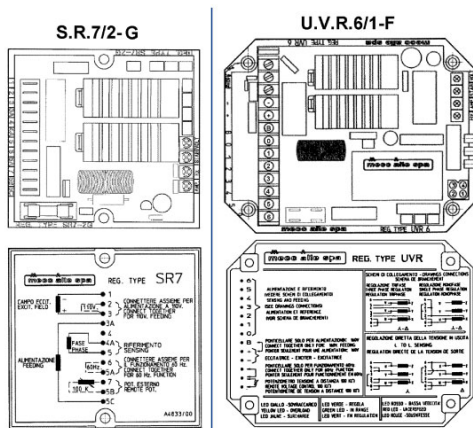

dis_ECO_025-r00

The following regulators are obsolete and were replaced by DSR/DER1 electronic regulators.

The U.V.R.6/1-F e S.R.7/2-G regulators may be equally used with the ECO series without altering performance.

The U.V.R.6/1-F was standard fit in the 38 - 40 - 43 - 46 types, while the S.R.7/2-G was standard fit in the 28 - 31 - 32 - 34 series.

The two regulators are perfectly equal as far as performance is concerned but they are different in terms of signaling and reference.

Remote Regulation

To obtain the remote regulation of voltage within a $\div 5\%$ range of the nominal value, insert:

- A 100K Ω potentiometer for the alternators equipped with 6 terminals
- A 100K Ω potentiometer in series with a 100K Ω resistor for the alternators with 12 terminals.

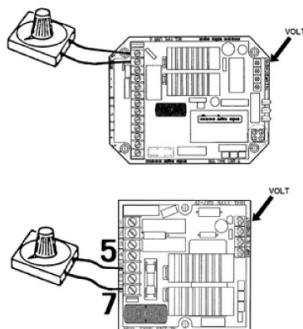

dis_ECO_026-r00

For a correct operation of the alternator connect the remote potentiometer as follows:

- Rotate the VOLT trimmer of the electronic regulator completely in anticlockwise direction.
- Position the external potentiometer at half scale and connect it with the corresponding terminals of the electronic regulator.
- Adjust the voltage to the nominal value through the VOLT trimmer of the electronic regulator.

Protections

To avoid anomalous and dangerous operation of the alternator, the U.V.R.6/1-F - S.R.7/2-G. analogic regulators are equipped with a low speed protection and an overload protection.

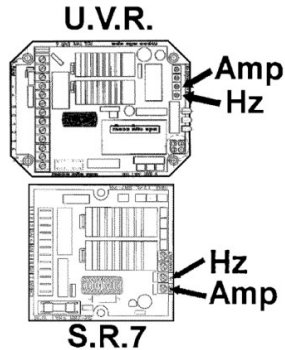

Low speed protection

Its intervention is instantaneous and it causes the reduction of the alternator voltage when the frequency under 10% of the nominal frequency.

The intervention threshold is set using the "Hz" potentiometer.

Overload protection

A dedicated circuit compares the partialized excitation voltage. If the preset value for this voltage (a value corresponding with a load current value equal to 1.1 times the current indicated on the alternator tag) is exceeded for more than 20 seconds, the regulator steps in lowering the alternator voltage and subsequently limiting the current within a safe value range.

The delay is expressly introduced to allow the motors that normally start in $5 \div 10$ seconds to pick-up. This intervention threshold may be adjusted using the "AMP" potentiometer.



If the alternator is used in single phase or with voltages different than the ones set by the manufacturer, a readjustment of the AMP and STAB potentiometers might be necessary.

U.V.R.6/1-F Signals

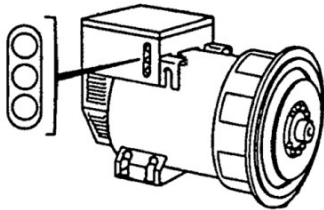

The U.V.R.6/1-F regulator has the following characteristics:

1. Possibility to also have a three phase reference besides the single phase one.
2. LED signals of auto diagnosis that indicate the operation conditions of the machine:
 - A green LED: if normally lit it indicates normal operation of the alternator.
 - A red LED: when lit it indicates the intervention of the low speed protection.
 - A yellow LED: when lit it indicates the intervention of the overload protection.



During normal operation of the alternator, only the green LED must be lit.

All these signals may be managed remotely and used for various purposes through the use of the SPD96/A device, available on request.

Causes that lead to protection intervention.

Instantaneous protection intervention for low speed	1 - Speed reduced by 10% as compared to the rated data.
Delayed protection intervention for overload	2 - Overload of 20% as compared to the rated data.
	3 - Power factor ($\cos \phi$) lower than the rated data.
	4 - Environmental temperature above 50°C.
Intervention of both protections	5 - Combination of factor 1 and factors 2, 3, 4.

In case both protections intervene, the voltage supplied by the alternator will drop to a value that depends on the size of the fault.

Voltage will be automatically restored to its nominal value when the fault is solved.

Optionals

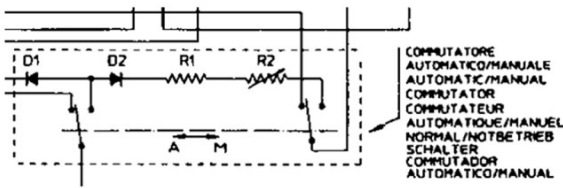

dis_ECO_029-r00

All the alternators in the ECO series may also be operated with manual regulation, without the assistance of external supplies and with the simple use of one rheostat.



See paragraph 12.4.

9 Maintenance

9.1 General Instructions



Warning

Before executing any maintenance operation, read carefully the instructions in chapter 3 "Safety" of this manual.



Warning

The authorized operators are only allowed to carry out the works they are specifically qualified for on the alternator and wear the required PPE (personal protective equipment).



Warning

Always disconnect the alternator from power supplies before carrying out any maintenance and/or replacement operation.



Warning

The alternators, when working, release heat even to a high level based on the power being generated. Before touching it wait for the alternator to cool off.



Danger

It is forbidden to pass through or stand under the alternator during the lifting and transportation stages.



It is advisable for the maintenance technician to keep a register of all the interventions.

The ECO series alternators are built to operate without maintenance for a long time.

The maintenance interventions on the Mecc Alte alternator are divided into ordinary and extraordinary.

9.2 Maintenance summary table

9.2.1 Summary table of ordinary maintenance operations

Acronyms of the intervention types: E = Electrical; M = Mechanical

Type	Description	Periodicity	Reference
M	Alternator exterior and interior cleaning	Every 15 days	9.3.7
M	General cleaning	Every 400 hours	9.3.1
M	Air filter cleaning (if present)	Every 400 hours of use	9.3.2
M	Visual Inspection	Every 2500 hours	9.3.3
M	Verification of winding state	Every 2500 hours	9.3.4
M	Verification of correct alternator operation	Every 2500 hours	9.3.5
M	Tightening torque check	Every 2500 hours	9.3.6

9.2.2 Summary table of extraordinary maintenance operations

Acronyms of the intervention types: E = Electrical; M = Mechanical; S = Software

Type	Description	Periodicity	Reference
M	Maintenance and potential replacement of bearings	Every 4000 hours	9.4.1
E	Winding state and diode bridge fastening check	Every 8000 hours / 1 year	9.4.2
S	Copy of the alarms of the digital regulator	Every 8000 hours / 1 year	9.4.3
M	Verification of correct PMG fastening (optional component)	Every 8000 hours / 1 year	9.4.4
M	Cleaning of windings	Every 20000 to 25000 hours	9.4.5

9.2.3 Summary table of maintenance operations in case of failure

Acronyms of the intervention types: E = Electrical; M = Mechanical

Type	Description	Periodicity	Reference
M	Fan replacement assembling	-	9.5.1
E	Verification and potential replacement of diode bridge	-	9.5.2
M	Mechanical disassembling for inspection (40-43-46 series)	-	9.5.3
M	Mechanical assembling (40-43-46 series)	-	9.5.4
M	PMG disassembling	-	9.5.5
M	PMG assembling (38 series)	-	9.5.6
M	PMG assembling (40-43-46 series)	-	9.5.7
M	Disc Holder Hub Removal (43 and 46 series)	-	9.5.8
E	Loss of residual magnetism (re-excitation of the machine)	-	9.5.9
E	Verification and replacement of voltage regulator	-	9.5.10
E	DSR test and setup on test bench	-	9.5.11
E	DER1 test and setup on test bench	-	9.5.12
E	DER 2 test and setup on test bench	-	9.5.13
E	Main stator windings voltage test	-	9.5.14

9.3 Ordinary Maintenance

Ordinary maintenance means the set of operations that are carried out on a regular basis.

Their purpose is to maintain the alternator in good operational state.



Caution

Carry out ordinary maintenance with accuracy and as often as specified by the manufacturer.

9.3.1 General cleaning



The intervention described in this paragraph refers only to the alternator, the frequency proposed must be adapted to the actual conditions and the frequency of use.



Danger

Disconnect the alternator from the power supplies. The drive motor must be off and unplugged from its power supplies.



Warning

Never use liquids or water.



Warning

Never clean the internal electrical components of the terminal box with pressurized air because short circuits or other malfunctions may occur.



Warning







Move close to the alternator only when it has zero power supply and it is at room temperature. It is only now that you may clean it on the outside with pressurized air.

Carry out general cleaning of the alternator and the surrounding area.

During the cleaning check the state and make sure that the various parts of the alternator are undamaged.

In case of anomalies or damages contact the maintenance technician for a potential intervention/replacement.

9.3.2 Air filter cleaning (if present)

Type of intervention 	Operator 	Periodicity  Every 400 hours of use
PPE to wear   		Materials and equipments Cleaning tools



Danger

Disconnect the alternator from the power supplies. The drive motor must be off and unplugged from its power supplies.



The intervention periodicity indicated refers to critical environmental conditions. Adapt the periodicity based on the actual conditions of use.

The air filters are accessories that are assembled on customer request.

Air filters must be regularly cleaned because they hold within a net that must be kept clean to guarantee the efficiency of the filter and the consequent good operation of the alternator.

The periodicity of intervention on the air filters will depend on the severity of the conditions at the installation place. However a regular inspection of these components will allow you to determine if you should intervene.

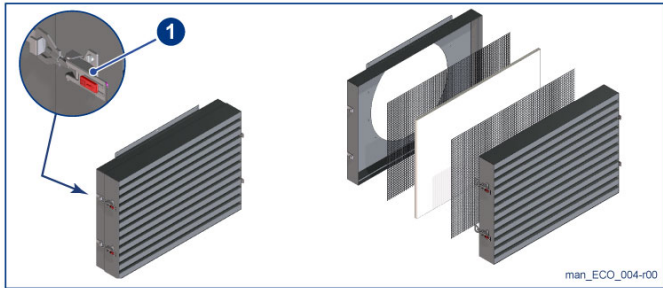



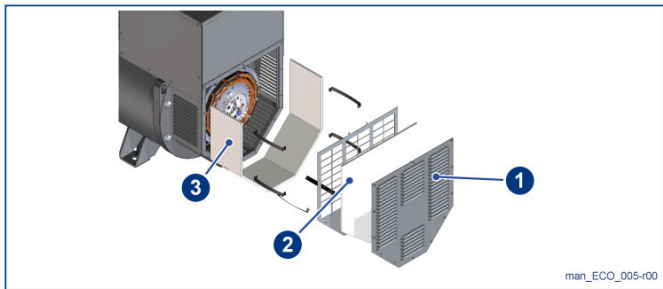





Open the four latches (1).
Remove the internal components of the filter and clean.



Remove the cover (1).
Remove the filter elements (2) and (3) and clean.









Reassemble everything according to the initial configuration.

9.3.3 Visual Inspection

Type of intervention 	Operator 	Periodicity  Every 2500 hours.
PPE to wear     		Materials and equipments Workshop tools.

- Check for the presence of anomalies such as cracks, rust, leakages and any other anomalous event.
- Check the tightening of the power cables and of the regulator cables.
- Check the state of the insulations of the power cables and of the regulator cables (overtemperature, rubbing).

9.3.4 Verification of winding state

Type of intervention 	Operator 	Periodicity  Every 2500 hours
PPE to wear     		Materials and equipments "Megger" Tester or similar to 500V in continuous voltage.

Danger
 Disconnect the alternator from the power supplies. The drive motor must be off and unplugged from its power supplies.

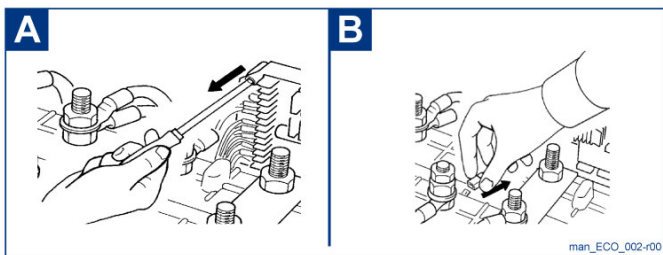



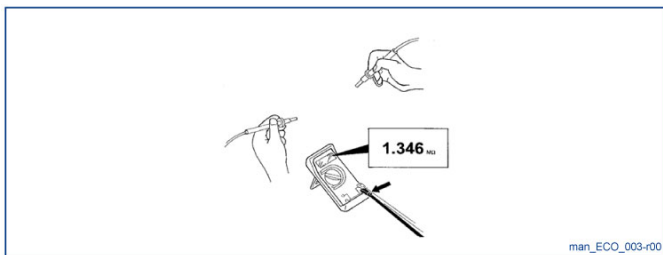





i Before carrying out the verification disconnect the voltage regulator (fig. A), the radio interference filters (fig. B) and all the other potential devices electrically connected to the windings to check.



Measure insulation resistance to ground.
The measured value of resistance to ground of all the windings must be higher than 1MΩ.

i If the value is lower than 1MΩ dry the windings with a jet of hot air at 50-60°C. Direct the jet of air into the air intakes and exhausts of the alternator.

9.3.5 Verification of correct alternator operation









Type of intervention 	Operator 	Periodicity  Every 2500 hours
PPE to wear     		Materials and equipments Workshop tools.

Check whether the alternator operates regularly without noises or anomalous vibrations.

In presence of noises and/or vibrations, check:

- The balancing of the rotor.
- The state of the alternator bearings. If necessary replace them (see 9.4.1.).
- The alignments.
- The potential presence of stresses in the heat engine.
- The potential presence of stresses in the anti-vibration supports.
- The functional data (see the nameplate of the alternator paragraph 1.6).

9.3.6 Tightening torque check

Type of intervention 	Operator 	Periodicity  Every 2500 hours
PPE to wear     		Materials and equipments The torque wrench.







Danger



Disconnect the alternator from the power supplies. The drive motor must be off and unplugged from its power supplies.

- Check the bolt tightening (see paragraph 9.6 "Tightening torques").
- Check the electrical connections.

9.3.7 Alternator exterior and interior cleaning

Type of intervention 	Operator 	Periodicity  Every 15 days
PPE to wear   		Materials and equipments Pressurized air.

Clean with pressurized air.

 It is strictly forbidden to use any kind of high-pressure water jet cleaners and detergent liquids. The standard protection rating of the alternator is IP23 and therefore by using liquids anomalies or even short circuits may occur.

 The intervention periodicity indicated refers to critical environmental conditions. Adapt the periodicity based on the actual conditions of use.

9.4 Extraordinary maintenance



Caution









Carry out extraordinary maintenance with accuracy and as often as specified by the manufacturer.



Warning

All the maintenance intervals described below refer to a normal use of the alternator. In case it is used in more severe conditions (high humidity, temperature or dust) it is necessary to check it more often.

9.4.1 Maintenance and potential replacement of bearings

Type of intervention 	Operator 	Periodicity  Every 4000 hours
PPE to wear     		Materials and equipments SKF LGMT2 or ENS or equivalent greases.



Danger

Disconnect the alternator from the power supplies. The drive motor must be off and unplugged from its power supplies.

- Check the state of the bearings.
- Lubricate the bearings if they are equipped with a lubricator.

Bearing lubrication table

Alternator type	Bearing type		Lubrication interval in hours		Amount of grease in grams	
	Coupling side	Side opposite the coupling	Coupling side	Side opposite the coupling	L.A.	L.O.A.
ECO 38	6318.2RS	6314.2RS	- (*)	- (*)	-	-
ECO 40	6322	6318.2RS	4000 (**)	- (*)	60	-
ECO 43	6324	6322	4000 (**)	4000 (**)	70	60
ECO 46	6330M	6324	4000 (**)	4000 (**)	90	70







* Sealed bearings: it is not necessary any maintenance during their entire operating life; in normal working conditions the estimated life is about 30,000 hours.

** In normal working conditions the regreaseble bearings have an estimated life of about 40,000 hours.

For any replacement of the bearings follow the instructions in paragraph 9.5.3

9.4.2 Winding state and diode bridge fastening check

Type of intervention	Operator	Periodicity
-----------------------------	-----------------	--------------------





		 Every 8000 hours / 1 year
PPE to wear   		Materials and equipments Workshop tools.

Danger

 Disconnect the alternator from the power supplies. The drive motor must be off and unplugged from its power supplies.

Remove the back grid of the alternator for visual inspection of the windings and to check the fastening of the diode bridge. If the windings are dirty or oily clean them with pressurized air. In case problems of other kind are detected you must disassemble the alternator to solve them.

9.4.3 Copy of the alarms of the digital regulator









Type of intervention 	Operator 	Periodicity  Every 8000 hours / 1 year
PPE to wear  		Materials and equipments Personal Computer + interface + dedicated software.

Danger

 Disconnect the alternator from the power supplies. The drive motor must be off and unplugged from its power supplies.

Mecc Alte's digital regulator are equipped with a special connector that allows you to download the data related to the recorded alarms. Download this data to check the potential presence of anomalies and, if any, solve them.

9.4.4 Verification of correct PMG fastening (optional component)

Type of intervention 	Operator 	Periodicity  Every 8000 hours / 1 year
PPE to wear     		Materials and equipments Workshop tools.

Danger



Disconnect the alternator from the power supplies. The drive motor must be off and unplugged from its power supplies.

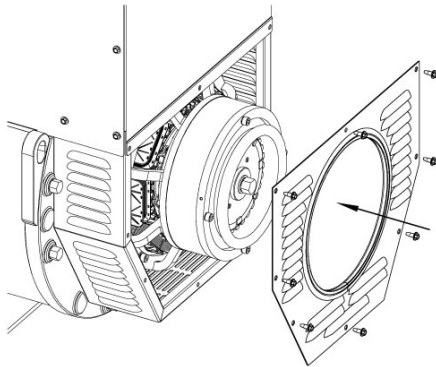

man_ECO_001-r00







You can add the PMG accessory to the ECO series alternators manufactured by Mecc Alte.

In case this accessory is present, make sure it is correctly attached.



See paragraph 9.5.6.

9.4.5 Cleaning of windings

Type of intervention 	Operator 	Periodicity  Every 20000 to 25000 hours.
PPE to wear   		Materials and equipments Cleaning tools

Danger



Disconnect the alternator from the power supplies. The drive motor must be off and unplugged from its power supplies.

Caution



If the system operates in a dusty environment, the cleaning operations must be carried out more frequently.



Cleaning must be carried out using adequate products.

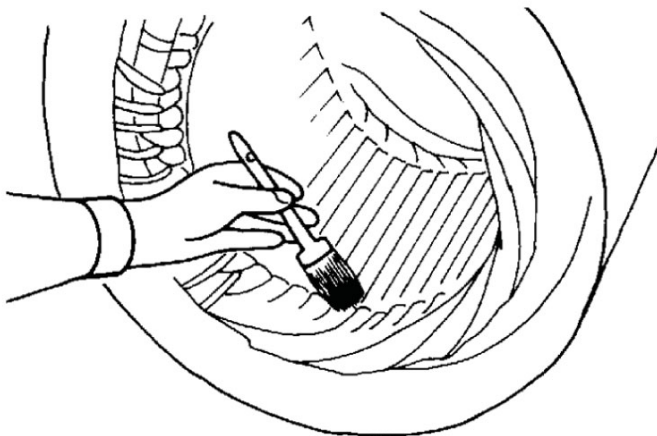









dis_ECO_001-r00

Disassemble the alternator for general cleaning. In such case it is advisable to replace the bearings for an optimization of the maintenance interventions for the entire group. The windings must be cleaned using a low pressure jet of hot water at a temperature below 80 °C or using adequate highly-evaporable solvents suitable for the cleaning of electrical windings. These solvents allow an adequate cleaning without damaging the insulation of the windings.

When the cleaning is finished it is advisable to check if there are any signs of overheating and potential traces of carbonizations. After the drying process at approximately 60-80°C is finished you must check again the insulation resistance of the windings. In case you notice a degradation of the winding paint, paint them again.

9.5 Maintenance in case of failure

9.5.1 Fan replacement assembly

Type of intervention 	Operator 	Periodicity 
PPE to wear     		Materials and equipments Workshop tools.

Danger



Disconnect the alternator from the power supplies. The drive motor must be off and unplugged from its power supplies.

Fan for ECO 38 - 40

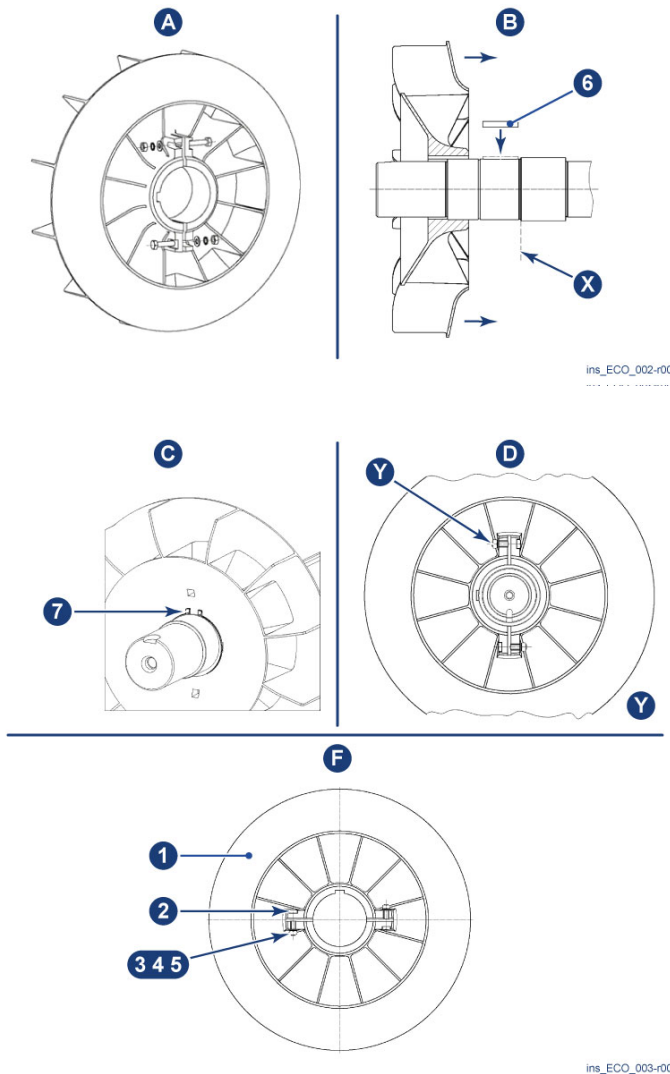

- A. Insert (without tightening) the bolts in the corresponding terminals of the fan.
- B. Assemble the key on the shaft (6) and insert the fan by bringing it to the end stop (X).

- C. Secure the fan with the appropriate Seeger ring (7).
- D. Tighten the bolts (Y) at 38 ± 5 Nm for the 38 series, at 40 ± 5 Nm for the 40 series.

No.	Description	Qty	Code
1	ECO 38 Fan	1	6102217303
1	ECO 40 Fan	1	6102217355
2	TE M10x50 Screw	2	6110605417
3	∅ 10 flat washer	2	6110613053
4	∅ 10 serrated washer	2	6110603250

No.	Description	Qty	Code
5	M10 Hexagonal nut	2	6110601046
6	ECO 38 A 16x10x60 key	1	9911130565
6	ECO 40 A 20x12x70 key	1	9911130595
7	ECO 38 D. 95 Seeger ring	1	9911136245
7	ECO 40 D. 120 Seeger ring	1	9911136265





Fan for ECO 43 - 46

The ECO 43-46 Series alternators use aluminum fans with a cast iron internal sleeve.

Assembling is carried out by heating the fan to 200 °C for 1 hour and then inserting it into the shaft.

A special extractor is used to remove it.

9.5.2 Verification and potential replacement of diode bridge

Type of intervention 	Operator 	Periodicity 
PPE to wear 		Materials and equipments Workshop tools.

Danger



Disconnect the alternator from the power supplies. The drive motor must be off and unplugged from its power supplies.

ECO 38

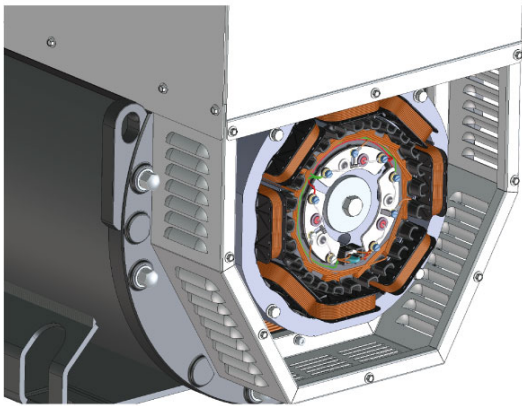

ECO 40 - 43 - 46

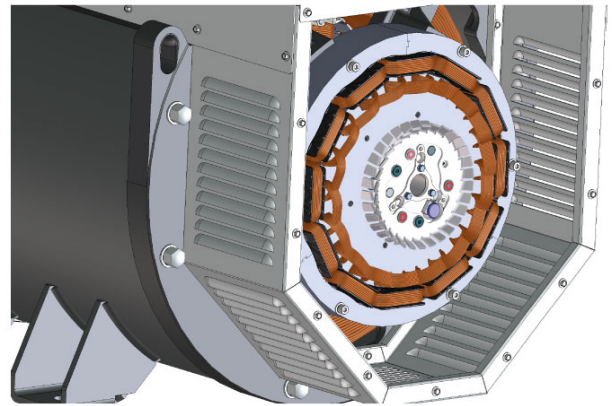









lay_ECO_001-r00

Based on the alternator type, the diode bridge may be made up of three separate sectors that each have two diodes attached (T30) or a single circular block with six diodes (T18).

The first configuration (T30) is used in the 38 Series alternators while the second (T18) is used in the 40-43-46 Series alternators. Every diode may be checked very easily with a multimeter set for diode verification; it is enough to completely disconnect the diode bridge under examination and to check every diode in both directions.

Once the sector or the entire bridge is replaced, tighten the corresponding screws with the correct tightening torques (see paragraph 9.6), and respecting the polarity.

9.5.3 Mechanical disassembly for inspection (40-43-46 series)





Type of intervention 	Operator 	Periodicity 
PPE to wear     		Materials and equipments Workshop tools.

Danger



Disconnect the alternator from the power supplies. The drive motor must be off and unplugged from its power supplies.

Summary Disassembly Procedure.

Front Cover	To remove the front cover gently tap with a rubber mallet.
Rotor	The rotor is extracted from the back cover using an appropriate extractor. Once the bearing has come out of its housing, the rotor may be extracted, tying it with soft ropes for movement.  During this operation you must be very careful not to damage the rotor windings.
Back cover	Before removing the back cover, disconnect the yellow-blue cables of the exciter stator from the regulator and free them of any fastening straps. During the removal of the back cover pull out the exciter stator cables as well.  Pull the cables out gently so as to prevent them from getting stuck and damaged.
General Inspection	Examine every component (windings: exciter, auxiliary winding, stator and rotor) to check the presence of damages.  Carefully check whether the crimp connectors are damaged.
Stator/Frame Inspection	<ul style="list-style-type: none"> ● Carry out a visual inspection of the stator and of the frame. ● Remove all dirt and dust. ● Repair all potential damages to the windings. ● Inspect the cable terminals and make sure they comply with the applicable regulations.
Shaft Inspection	Examine the shaft and the housings for the keys to check the presence of any sign of corrosion, burrs or wear. Clean them and, if necessary polish them.  If the degree of wear of the shaft is too high, take it to a service center for repair or replacement.

Front/Back bearing disassembling

- Both bearings must be removed using the appropriate extractors.
- The sizes of the bearings must be measured accurately to check the presence of excessive wear.
- In case of excessive wear or anomalous noises / vibrations, replace them.

Electrical Inspections

Check the cable terminals and make sure they guarantee good contact. Make sure there are no signs of corrosion and/or oxidation.

Check whether the cable sheath is undamaged. If there are damage signs, repair or replace the cable.

Using adequate tools, check the resistance, the continuity and the insulation of the following windings (see paragraph 9.5.14):

- Main Stator.
- Auxiliary Winding.
- Main rotor.
- Exciter Stator.
- Exciter Rotor.
- Thermal probes (if present).
- PMG (if present).

Check whether the diodes and the varistor are damaged.



All the measurement tools must be calibrated.

Insulation checks

Check the insulation resistance of the following windings:

Main Stator:

- Between phases and between phases and ground.
- Between phases and the auxiliary winding.
- Between auxiliary winding and ground.

Main rotor and exciter rotor:

- Between winding and ground.

Exciter Stator:

- Between winding and ground.

PMG (if present):

- Between winding and ground.

The AVR may be controlled on a static bench or during the operating test of the machine



See paragraph 9.5.10; 9.5.11; 9.5.12; 9.5.13.

The internal windings of the machine might need accurate cleaning. Use an appropriate solvent or hot water. Dry them and, if necessary, impregnate them again.

Detailed disassembling procedure



Remove the cover of the terminal box and the pertaining panels, disconnect the digital regulator then remove the back latch and the back carter.

Cut the regulator cable fastening straps then pull the yellow and blue wires of the exciter stator through the cable gland hole.

Secure the exciter stator to an appropriate lifting device using a soft belt.

Remove the fixing screws and , using a lever, extract the exciter stator, being careful not to damage the windings.

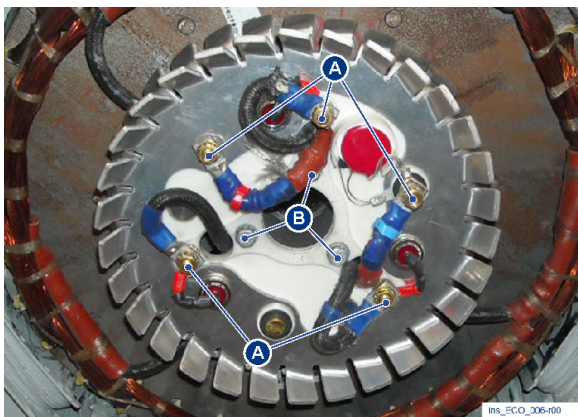

i Memorize the position of the wires so as to be able to reconnect them in the original position at the end of the intervention.

Disconnect the wires (A) connected to the rotating diode bridge (three wires from the exciter rotor and two wires from the main rotor).

Unscrew the three M5 screws (B) and remove the rotating diode bridge.

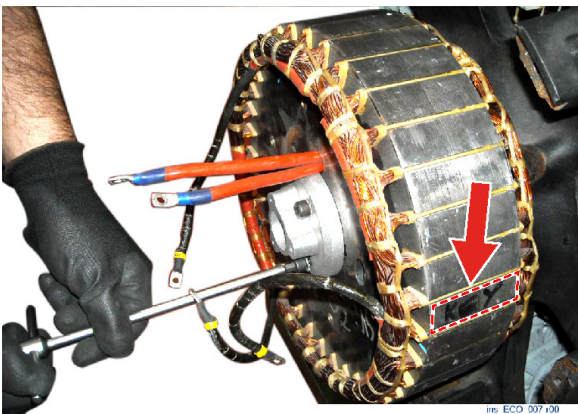

Unscrew the three M8 screws and remove the blocking hub of the exciter rotor.

Use a felt pen to mark on the exciter rotor the position of the key on the shaft.

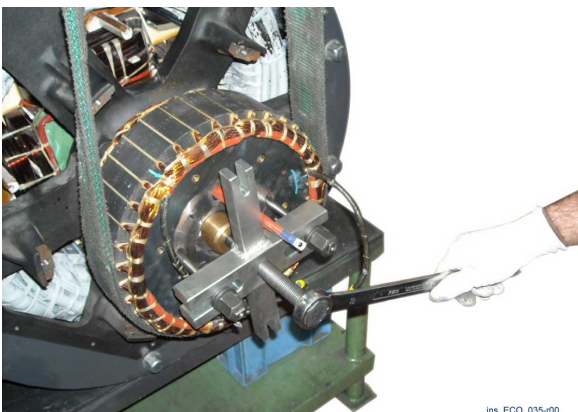

Secure the exciter stator to an appropriate lifting device using a soft belt.

Remove it with the appropriate Mecc Alte extractor.

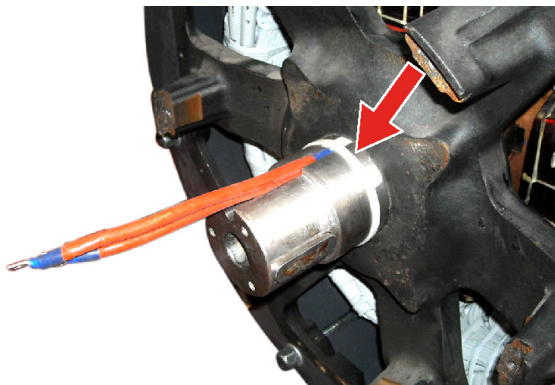

ins_ECO_006-r00

Cut the fastening strap of the cables of the main rotor on the shaft.

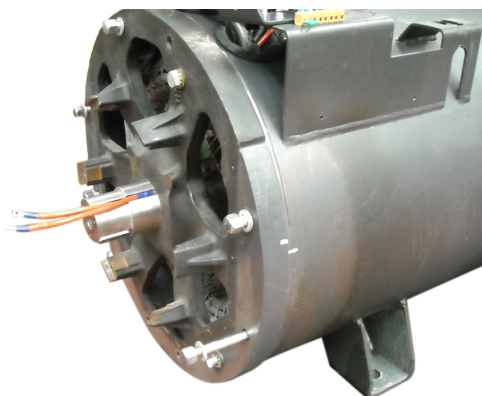

ins_ECO_010-r00

Use a felt pen to mark the position of the front and back cover with respect to the frame to allow their correct reassembling.

38-40 Series: Remove the fixing rods of the front and back covers.

In the 43-46 covers the rods are replaced by normal bolts.



ins_ECO_011-r00

Hook the front cover to a lifting device.

Tap with a rubber mallet to remove it from the frame.

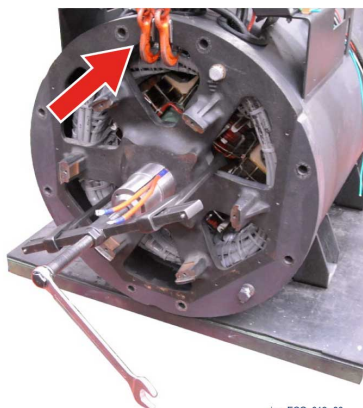

ins_ECO_012-r00

Hook the back cover to a lifting device.

Use an extractor to push the shaft until the bearing comes out completely from its housing.

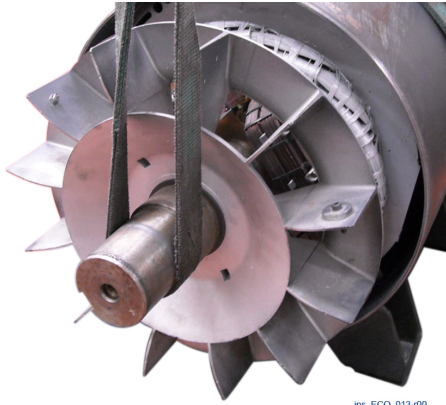

ins_ECO_013-r00

Pass a soft belt on the shaft end and slightly lift the rotor.
Start pushing it to extract it.

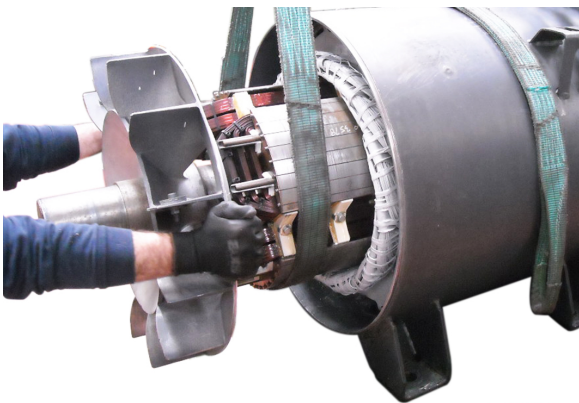

ins_ECO_014-r00

As soon as possible, place the shaft end on an adequate support.
Move the soft rope onto the rotor pack and start extracting it.

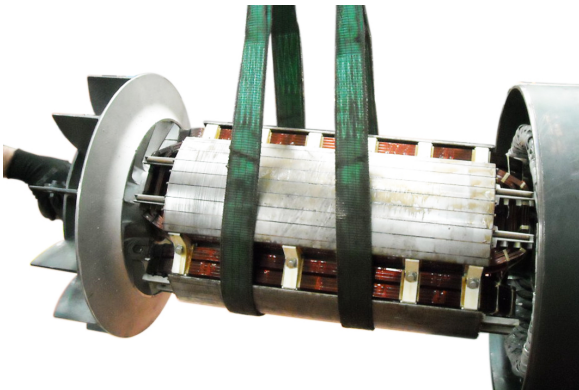

ins_ECO_015-r00

As soon as the rotor sticks out enough, support it with a second soft belt.
Remove it from the frame and put it in a safe place.

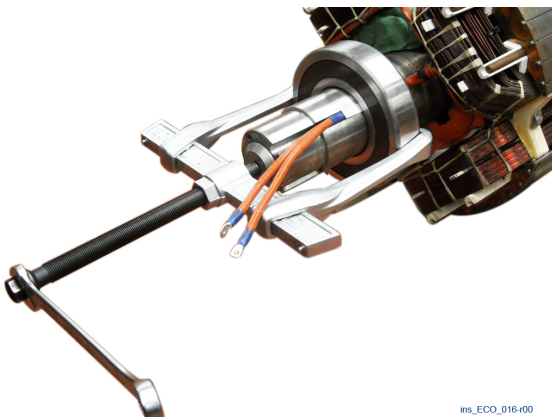

ins_ECO_016-r00

Use an extractor to remove the bearing.

9.5.3.1 Note for removal of ECO 43 - 46 alternators

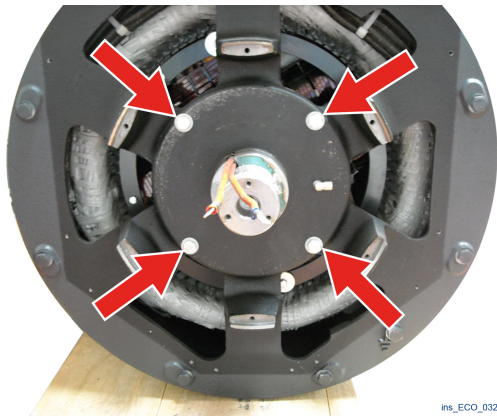

ins_ECO_032-r00

Before disassembling the back cover remove the four fixing bolts of the bridge.

On the 43 Series there is an additional grease protection ring. Be extremely careful when reassembling to center it well.

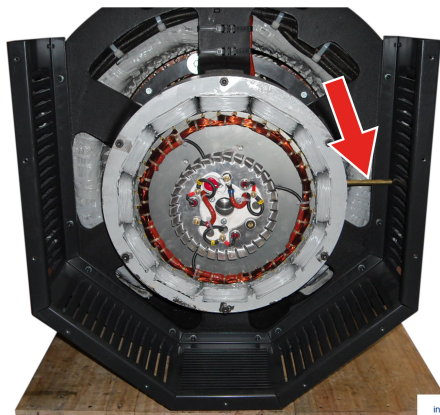

ins_ECO_034-r00

When disassembling it the lubricator tube for the bearing must be removed before removing the back carter.

When reassembling it, the lubricator tube is mounted right after the back carter is attached.

9.5.4 Mechanical assembling (40 - 43 - 46 series)

Reassembling bearings

Heat the bearings in an appropriate induction equipment.
Insert them into the shaft by pushing them to the end stop against the shoulder.



The heating temperature must not exceed the limit imposed by the manufacturer.

Rotor



Reassemble the rotor being very careful not to damage the windings.

Front Cover

To remove the front cover gently tap with a rubber hammer.

Back cover

During the assembling check the voltage of the exciter stator wires to avoid damaging them.

Fixing rod/bolts

To assemble the fixing rods and bolts use new washers and tighten them with the correct tightening torque.

In case of double-bearing alternators, once assembled, turn them manually to check whether there are impediments and anomalous noises.

In case of single-bearing alternators, this check must be carried out during the test, after the coupling with the drive motor.

Assembling Procedure



Caution

Use anti-burn gloves.

Heat a new bearing to 110°.



See paragraph 9.4.1.

Insert the new bearing on the shaft, push it to the end stop.
Wait for the bearing to cool off. Then start reassembling the alternator.

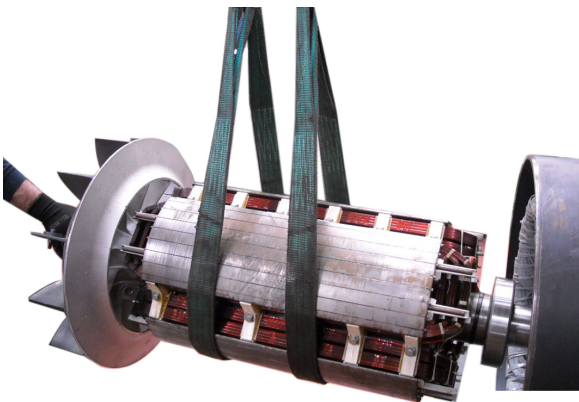

Lift the rotor using two soft belts.
Introduce the rotor in the frame.

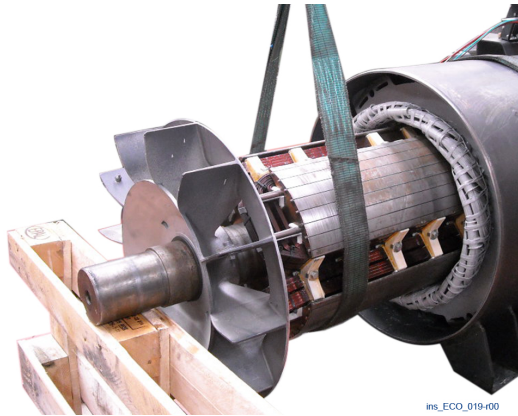

As soon as possible, remove one of the soft belts and continue inserting the rotor.



Keep an adequate support under the shaft end.

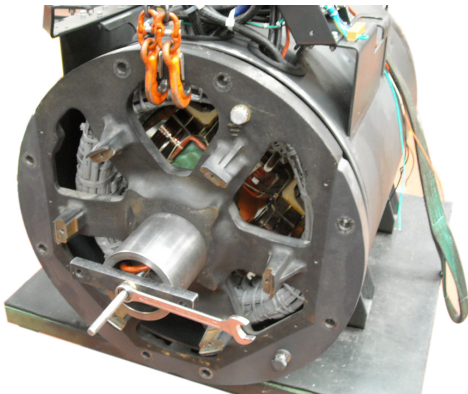

Using an appropriate lifting system, lift the back cover and put it in position.

Screw a threaded bar in the hole on the shaft.

Screw a nut on the threaded bar. Insert a cylindrical spacer, overlapped by an adequate plate, between the nut and the back cover.

Screw the nut in to introduce the bearing in the housing of the back cover.

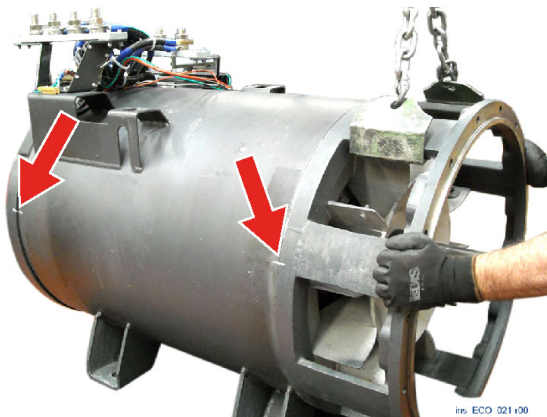

Lift the front cover and put it in position. Make sure you line up the (felt pen) marks made earlier on the covers and the frame.

Fasten the rods (for 38 - 40 Series) or the bolts (for 43 - 46 Series) to the tightening torques. See paragraph 9.6).

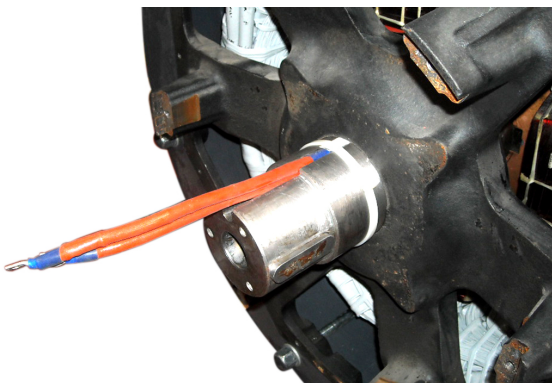

Fasten the cables of the main rotor to the shaft with a strap.

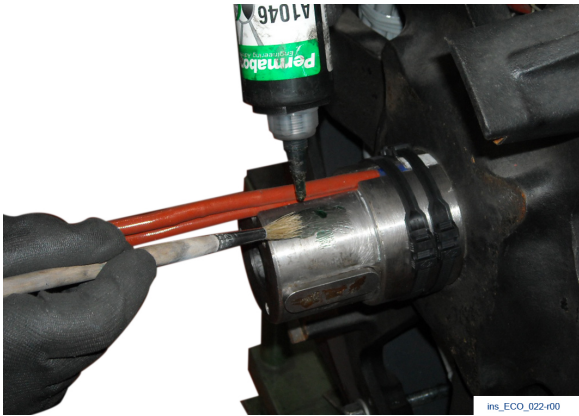

Clean the exciter rotor housing on the shaft. Remove the dirt and any residual glue.

Sprinkle it with Loctite Permabond A1046 glue or equivalent.



Clean the hole of the exciter rotor. Remove the dirt and any residual glue.

Sprinkle it with Loctite Permabond A1046 glue or equivalent.

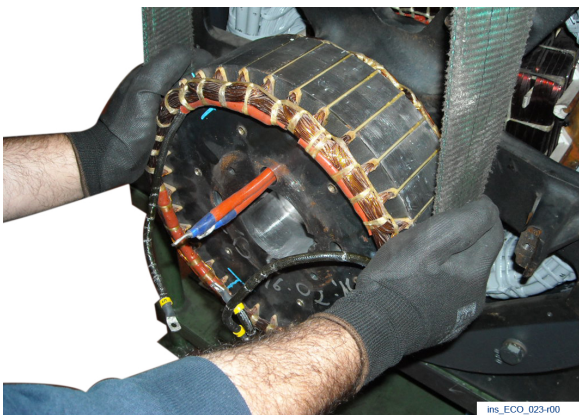

Using an appropriate lifting system and a soft belt, lift the exciter rotor.

Introduce the rotor into the shaft, in its original position. Carefully observe the position of the key marked during the assembling stage.

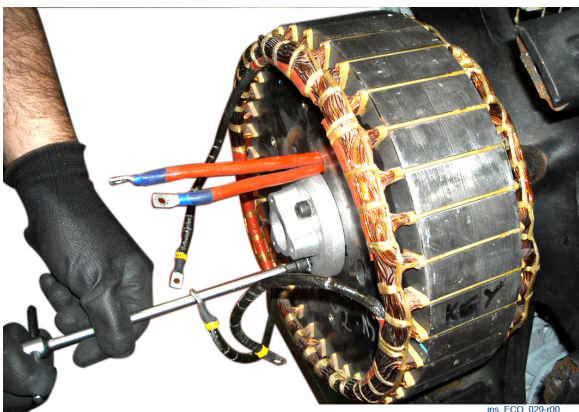

Screw the three M8 screws to 21Nm to fasten the blocking hub of the exciter rotor.



Insert the rotating diode bridge and screw in the 3 M5 screws to 3.3 Nm.

Rewire the three cables of the exciter rotor and the two cables of the main rotor in their initial configuration.

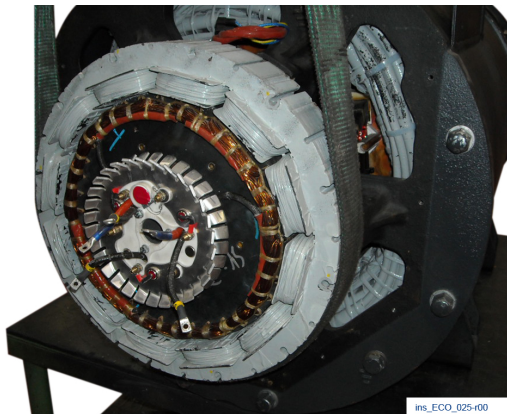

Using a soft belt lift the exciter stator.

Introduce the exciter stator in the housing with the cables positioned inward and oriented upward.









Insert the fixing bolts and screw them with a torque of 25 Nm.

Pass the yellow and blue cables of the exciter stator through the cable gland hole on the frame.

Connect them to the regulator and fasten them with appropriate straps as in the original configuration.

Reassemble the back carter, the back housing and the terminal box.

9.5.5 PMG disassembling

Type of intervention 	Operator 	Periodicity 
PPE to wear     		Materials and equipments Workshop tools.

Danger



Disconnect the alternator from the power supplies. The drive motor must be off and unplugged from its power supplies.

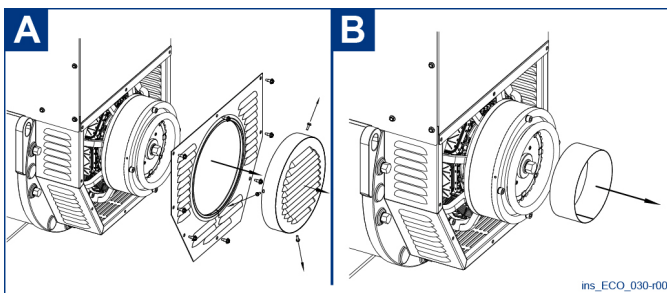

A. Remove the protective cover and grid.

B. Re-introduce the paper spacer.

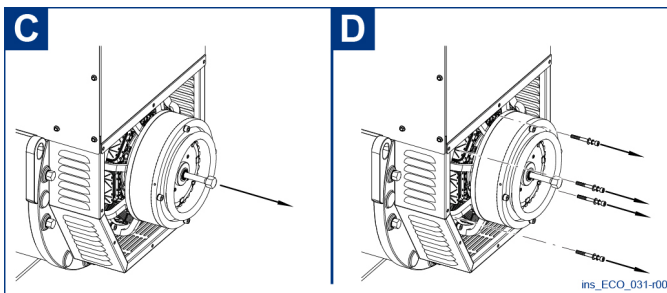









C. Loosen the central M14 rod and, without removing it completely, use as a lever on the PMG device to uncouple it from the exciter rotor.

Secure the PMG to an appropriate lifting device using a soft belt.

D. Remove the 4 M8 screws .

Use a lever to remove the PMG device from the exciter stator, being careful not to remove the exciter stator too.

9.5.6 PMG assembling (38 series)

Type of intervention 	Operator 	Periodicity 
PPE to wear     		Materials and equipments Workshop tools.

Danger
 Disconnect the alternator from the power supplies. The drive motor must be off and unplugged from its power supplies.

i On the 38 Series the PMG is available only on express customer request made when ordering the machine. In fact the standard machine does not envisage the possibility to assemble this accessory.

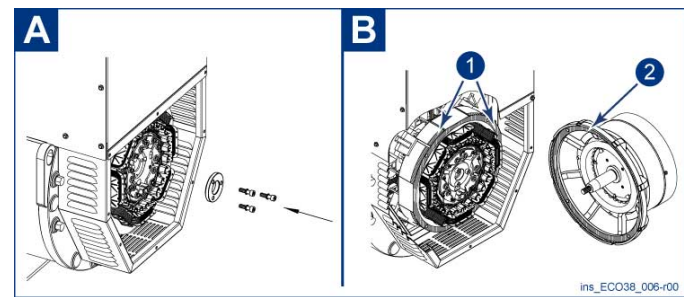

A. Center the fixing washer in the exciter rotor and screw in the three M8 screws applying a 21 Nm torque.
 B. Accurately clean the exciter stator removing the paint (1) and remove the paint on the PMG (2).

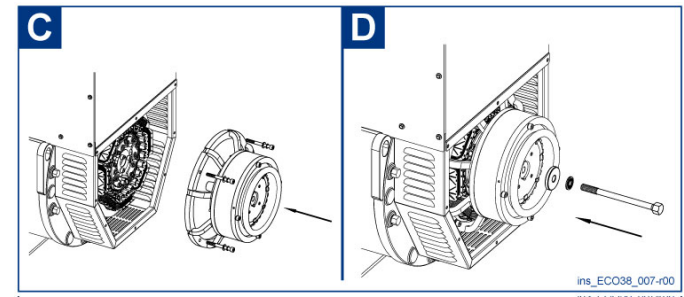

C. Match the PMG to the exciter stator and center the flange, screw in the 4 M8 screws provided applying a 25 Nm torque.
 D. Center the washer for the central rod in the rotor pack and screw in the central M14 rod applying a 120 Nm torque.

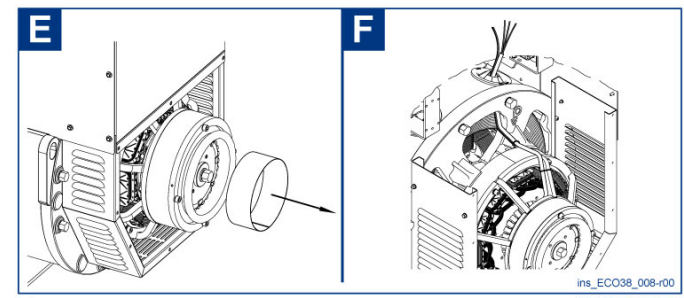



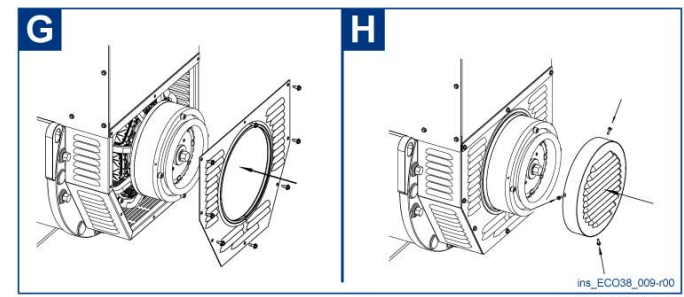





E. Remove the paper spacer.
 F. Make sure the PMG is perfectly placed in the housing by checking that the rotating part rotates freely without any interference, then pass the wires as shown in the figure and connect them to the regulator according to the diagram.



G. Insert the special IP23 back grid and screw in the 8 M6 screws applying a 9 Nm torque.
 H. Insert the IP23 protective cover and screw in the 3 M4 screws applying a 1.5 Nm torque.

9.5.7 PMG assembling (40-43-46 series)

Type of intervention 	Operator 	Periodicity 
PPE to wear     		Materials and equipments Workshop tools.

Danger



Disconnect the alternator from the power supplies. The drive motor must be off and unplugged from its power supplies.

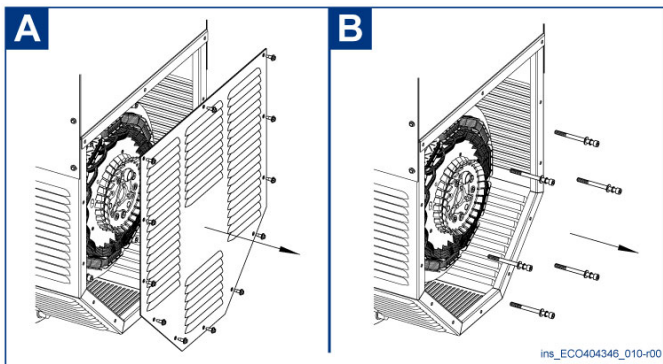

- A. Remove the IP 23 back protective cover.
- B. Remove the 6 M8 screws of the exciter stator.

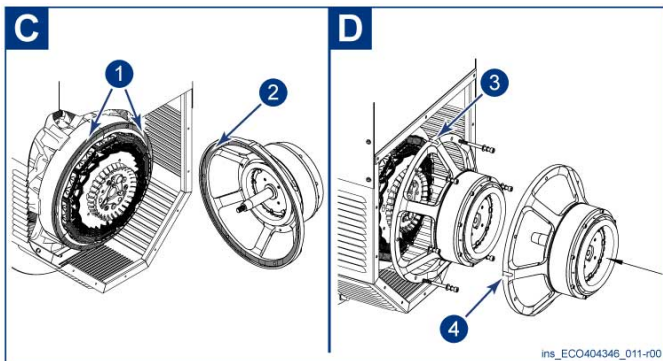

- C. Accurately clean the area indicated in the drawing of the exciter stator (1) and remove the paint from the PMG device (2).
- D. Match the PMG to the exciter stator making sure you position correctly the reference for the ECO40 (3), ECO43-46 (4) and you center the flange, screw in the 6 M8 screws provided applying a 25 Nm torque.

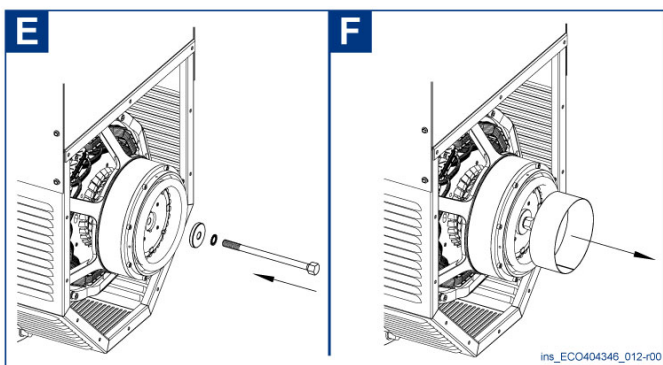

- E. Center the washer for the central rod in the rotor pack and screw in the central M14 rod applying a 120 Nm torque.
- F. Remove the paper spacer.

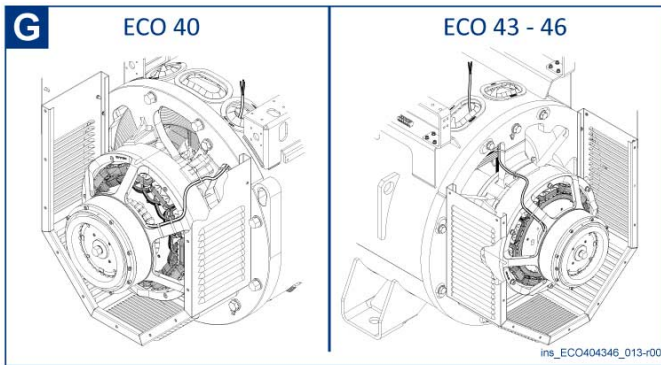



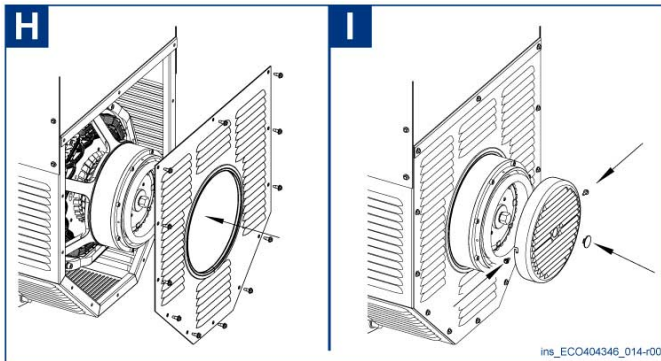





G. Make sure the PMG is perfectly placed in the housing by checking that the rotating part rotates freely without any interference, then pass the wires as shown in the figure and connect them to the regulator according to the diagram.



H. Insert the special IP23 back grid and screw in the 12 screws applying a 12 Nm torque.

I. Insert the IP 23 protective cover and screw in the 2 screws at 3.5 Nm and insert the cap nut.

9.5.8 Removal of disc holder hub

Type of intervention 	Operator 	Periodicity 
PPE to wear     		Materials and equipments Workshop tools.

Danger
 Disconnect the alternator from the power supplies. The drive motor must be off and unplugged from its power supplies.

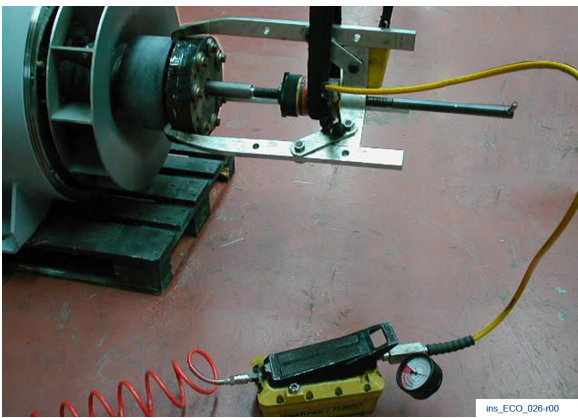





Use an appropriate hydraulic extractor to extract the hub.
For the 43 and 46 series use an additional flange attached to the hub.



Heat the disc holder hub. Use two oxyacetylene heating torches.
Keep the extractor under pressure until full extraction of the hub.

 Before reassembling the hub heat it to 250 °C for 1 hour.

9.5.9 Loss of residual magnetism (reexcitation of the machine)

Type of intervention	Operator	Periodicity
		
PPE to wear		Materials and equipments
		Battery, electrical wires and resistance.

Danger



Disconnect the alternator from the power supplies. The drive motor must be off and unplugged from its power supplies.



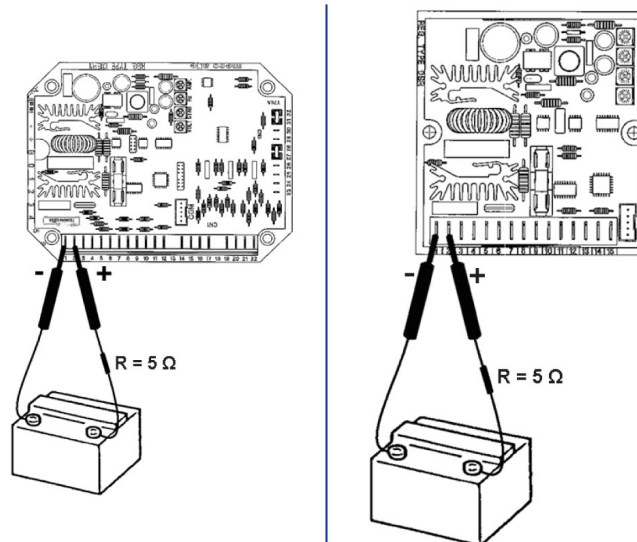

The following procedure applies to the alternators equipped with an electronic regulator and must be applied in case the alternator does not self-excite (in such case, even if rotating at nominal speed, voltage is not present in the main terminal block of the alternator):



lay_ECO_002-00

- With the alternator off, remove the cover of the terminal box.
- Prepare two terminals connected to a 12 Vdc battery possibly with a 5 Ω resistance in series.
- Use the electrical diagrams provided by Mecc Alte to identify the “+” and “-” terminals of the electronic regulator.
- Start the alternator.
- Apply for an instant the two terminals to the previously identified terminals being very careful to respect the polarity (“+” terminal of the regulator with the “+” terminal of the battery, “-” terminal of the regulator with the “-” terminal of the battery).
- Use a voltmeter or the corresponding board tools to check whether the alternator generates the nominal voltage indicated on the "nameplate" of the alternator.

9.5.10 Verification and replacement of voltage regulator

Type of intervention	Operator	Periodicity
		
PPE to wear		Materials and equipments
		Workshop tools.



Danger

Disconnect the alternator from the power supplies. The drive motor must be off and unplugged from its power supplies.

The alternators are equipped with an automated voltage regulator: depending on the alternator type, the electronic regulators may be of 4 types: DSR, DSR/A, DER1, DER1/A.

The standard supply comes with the DSR on the 38 Series and the DER1/A on the 40-43-46 Series.



DER1 can be mounted on the 38 Series and DSR/A can be mounted on the 40-43-46 Series on customer request.



In case there are voltage regulation problems not ascribable to an erroneous adjustment of the VOLT, STAB, Hz and AMP potentiometers and/or to the system (fully assembled machine + load), follow the procedure below for an in-depth check of the voltage regulator.

Visual Inspection of the Regulator



Do not change the position of the VOLT, STAB, Hz and AMP potentiometers before marking their position.

In particular check for:

- Mechanical damages of various kinds.
- State of fuses.
- Undamaged state of electrical connections.
- Potential presence of burned electrical components.
- Presence of the silicone protection in the Hz and AMP potentiometers.

Check the SCR resistance and flyback diode.

Before doing this test, check that the fuse is inserted and undamaged.

- Flyback diode: it is working if the diode test performed between pin 1 and 2 has a positive result.
- SCR: it is working if a resistance of some hundred K Ω is measured between pin 1 and 8 (in the DSR) or between pin 1 and 2 (in the DER1 regulator).

A resistance measure close to zero signals a SCR failure.

A reason for the damaging of these components may be the erroneous cabling of the alternator regulator.

Copy the data and alarms of the regulator.

To avoid creating new alarms, the copy of the data and alarms existing in the regulator (.dat and .alr files) must be made feeding the alternator with an appropriate continuous voltage, in accordance with the diagrams below.



The correct supply and operation of the software are signaled by a green LED flashing with a 1 second period. If the LED is not lit try to turn the power supply system off and restart it.

Testing on static bench (see paragraph 9.5.11, 9.5.12, and 9.5.13)

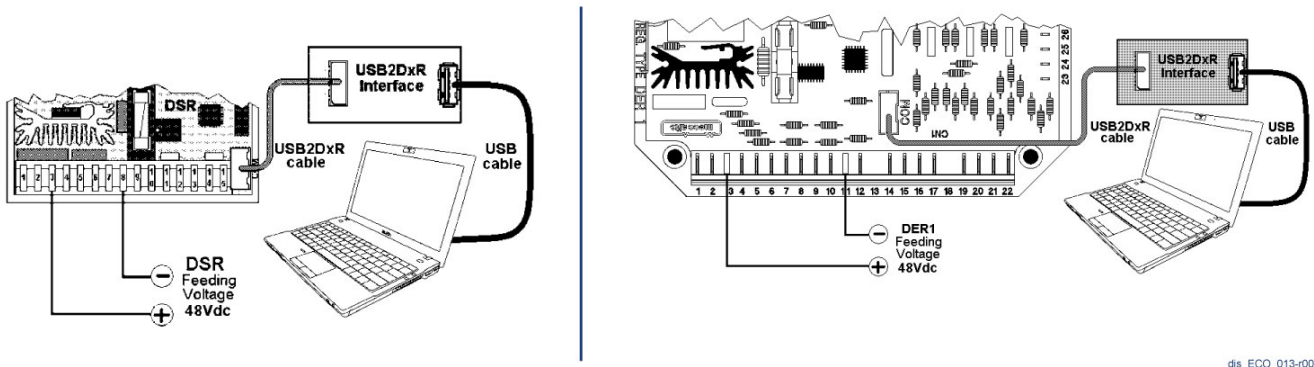

- Register the position of the VOLT, STAB, Hz and AMP potentiometers reading the L[32], L[33], L[34] and L[35] corresponding parameters and the state parameters, reading L[36], L[37], L[38] and L[39].
- Check the correct operation of the VOLT, STAB, Hz and AMP potentiometers, rotate them completely in anticlockwise and clockwise direction, the value of the L[32], L[33], L[34] and L[35] parameters must be 64 in one direction and 32760 in the other direction.
- Register the L[41] parameter; with the external potentiometer unconnected you should read a value of 16384; otherwise the external potentiometer circuit is damaged.
- Voltage regulation test: set the VOLT, STAB and Hz potentiometers to notch 6 then rotate the AMP potentiometer completely in clockwise direction. Read the L[43] and L[44] parameters.

When rotating the VOLT potentiometer in anticlockwise or in clockwise direction, the value of the L[43] parameter should respectively decrease or increase.

Check and confirm the following behavior: if the L[43] value is higher than the L[44] value, the bench light bulb should brighten. If instead the L[43] value is lower than the L[44] value, the light bulb should dim until it shuts off.

The light bulb represents the fictitious load connected between connectors 1 and 2 of the digital regulator.

- AMP protection test: set the STAB and Hz potentiometers to notch 6, then rotate the AMP potentiometer completely in clockwise direction; then rotate the VOLT potentiometer so as to have L[43] higher than L[44], the bench light bulb on and no active alarm.

Read the L[45] parameter and set the AMP potentiometer (reading the L[35] parameter for the SN equipped regulators with a yellow tag, or L[55] for the SN-equipped regulators with a blue tag, to a lower value than the value of the previously read L[45] parameter. Check the intervention of the AMP protection (alarm 5).

Once you established that the regulator must be replaced, proceed as follows:

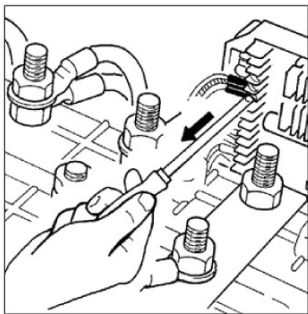

ins_ECO_004-r00

- Disconnect all the connection wires in the terminal block.
- Unscrew the blocking 2/4 screws of the regulator.

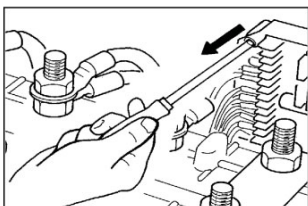





ins_ECO_005-r00

- Place the new regulator in the specified position.
- Fasten the new regulator with the previously collected screws.
- Reconnect all the wires to the terminal block of the regulator, using, if necessary, the diagrams provided by Mecc Alte.

In case you detect anomalous behavior please refer to the specific regulator manual or contact Mecc Alte's technical support service

9.5.11 DSR test and setup on test bench

Type of intervention 	Operator 	Periodicity 
PPE to wear 		Materials and equipments Personal computer+interface+software .

Danger



Disconnect the alternator from the power supplies. The drive motor must be off and unplugged from its power supplies. Disconnect the regulator and connect to a computer according to the diagrams below. The operations of functional checkout and parameter setting may be easier if they are performed on a test bench rather than with the regulator still inside the terminal box.

Caution



Given that some parts of the DSR which work with a high potential are not isolated, for the safety of the operator, it is necessary for the power source to be isolated from the electrical grid, for instance by a transformer.

Caution



The use of these types of connection is reserved to qualified personnel, able to assess the operational risks of high voltage and who have a full knowledge of the content of this manual.

The connection diagrams of the DSR and the USB2DxR communication interface are shown in figures (A), (B) or (C) in this paragraph based on the requested function and on the available supply voltage.

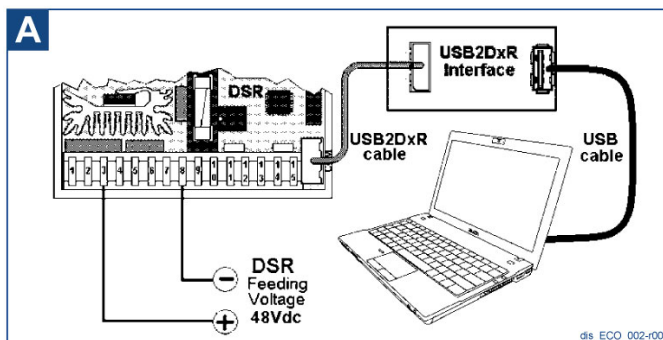

DSR 48Vdc power supply for the download of the alarms without risking to change to content of the EEPROM because of the tests.



No other connections besides the power supply are needed.

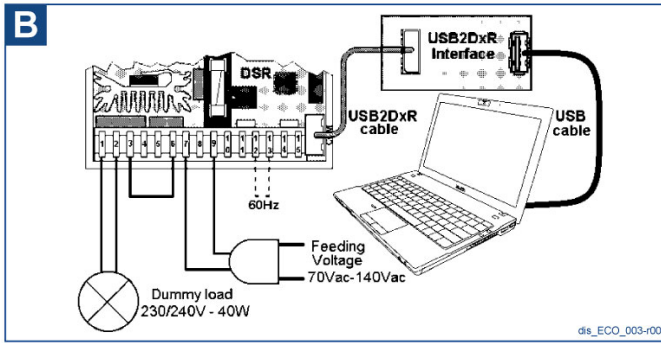

DSR 70-140Vac power supply for test and setup.



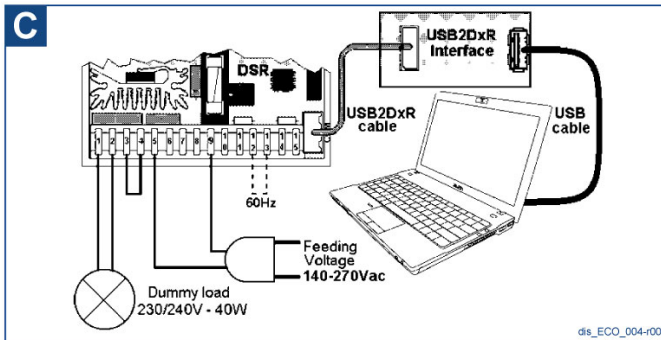

i The fictitious load between terminals 1 and 2, the sensing on terminal 7 and the bridge between terminals 6 and 3 of the DSR.



DSR 140-140Vac power supply for test and setup.

i The fictitious load between terminals 1 and 2, the sensing on terminal 5 and the bridge between terminals 3 and 4 of the DSR.

9.5.12 DER1 test and setup on test bench

Type of intervention 	Operator 	Periodicity 
PPE to wear 		Materials and equipments Personal computer+interface+software .

Danger



Disconnect the alternator from the power supplies. The drive motor must be off and unplugged from its power supplies. Disconnect the regulator and connect to a computer according to the diagrams below. The operations of functional checkout and parameter setting may be easier if they are performed on a test bench rather than with the regulator still inside the terminal box.

Caution



Given that some parts of the DER1 which work with a high potential are not isolated, for the safety of the operator, it is necessary for the power source to be isolated from the electrical grid, for instance by a transformer.

Caution



The use of these types of connection is reserved to qualified personnel, able to assess the operational risks of high voltage and who have a full knowledge of the content of this manual.

The connection diagrams of the DER1 and the USB2DxR communication interface are shown in figures (A), (B) or (C) in this paragraph based on the type of available power supplies.

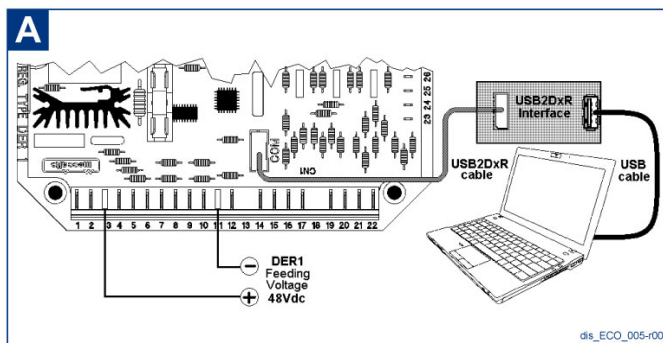

DER1 48Vdc power supply for the download of the alarms without risking to change to content of the EEPROM because of the tests.



No other connections besides the power supply are needed.

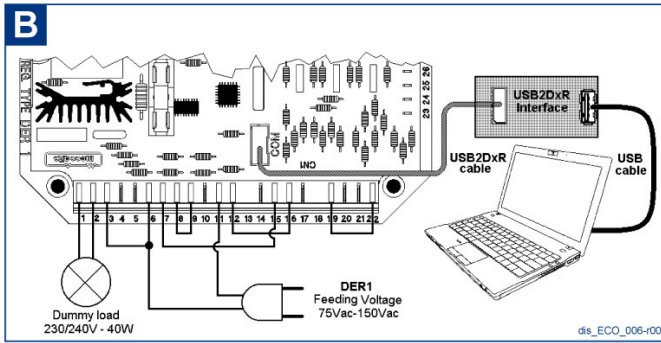

DER1 75-150Vac power supply for test and setup.



The fictitious load between terminals 1 and 2, the sensing on terminal 6 and the bridge between terminals 8 and 9, 7 and 15, 12 and 16, 19 and 22.

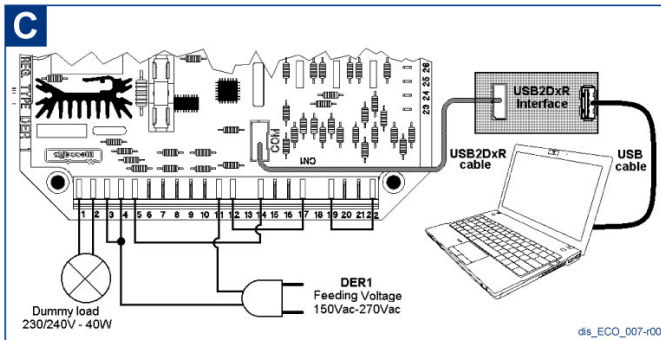





DER1 150-150Vac power supply for test and setup.



The fictitious load between terminals 1 and 2, the sensing on terminal 4 and the bridge between terminals 5 and 14, 12 and 17, 19 and 22.

9.5.13 DER 2 test and setup on test bench

Type of intervention 	Operator 	Periodicity 
PPE to wear 		Materials and equipments Personal computer+software.

Danger



Disconnect the alternator from the power supplies. The drive motor must be off and unplugged from its power supplies. Disconnect the regulator and connect to a computer according to the diagrams below. The operations of functional checkout and parameter setting may be easier if they are performed on a test bench rather than with the regulator still inside the terminal box.

Caution



Given that some parts of the DSR which work with a high potential are not isolated, for the safety of the operator, it is necessary for the power source to be isolated from the electrical grid, for instance by a transformer.

Caution



The use of these types of connection is reserved to qualified personnel, able to assess the operational risks of high voltage and who have a full knowledge of the content of this manual.

The connection diagrams of the DER2 are shown in figures (A), (B) or (C) in this paragraph based on the type of available power supplies.

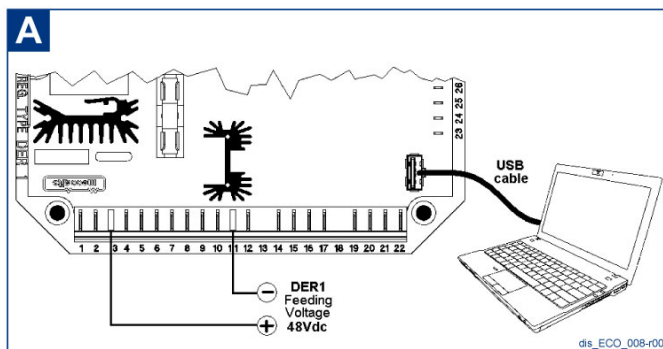





DER1 48Vdc power supply for the download of the alarms without risking to change to content of the EEPROM because of the tests.

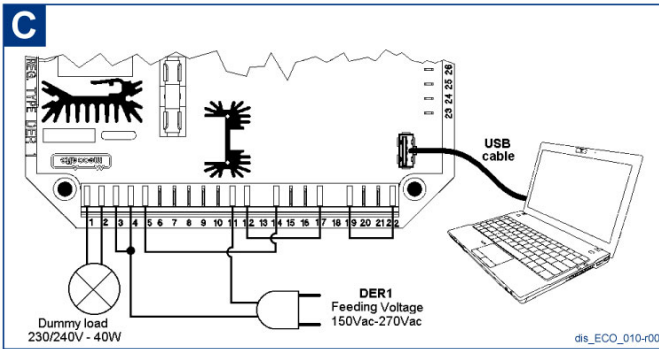
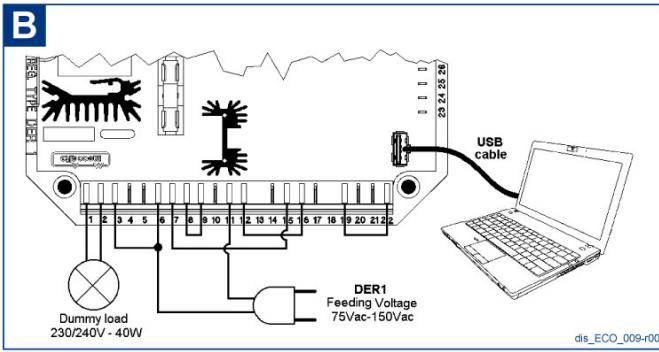

No other connections besides the power supply are needed.



9.5.14 Main stator windings voltage test

Type of intervention 	Operator 	Periodicity 
PPE to wear 		Materials and equipments Electrical tools.

Danger  Disconnect the alternator from the power supplies. The drive motor must be off and unplugged from its power supplies.

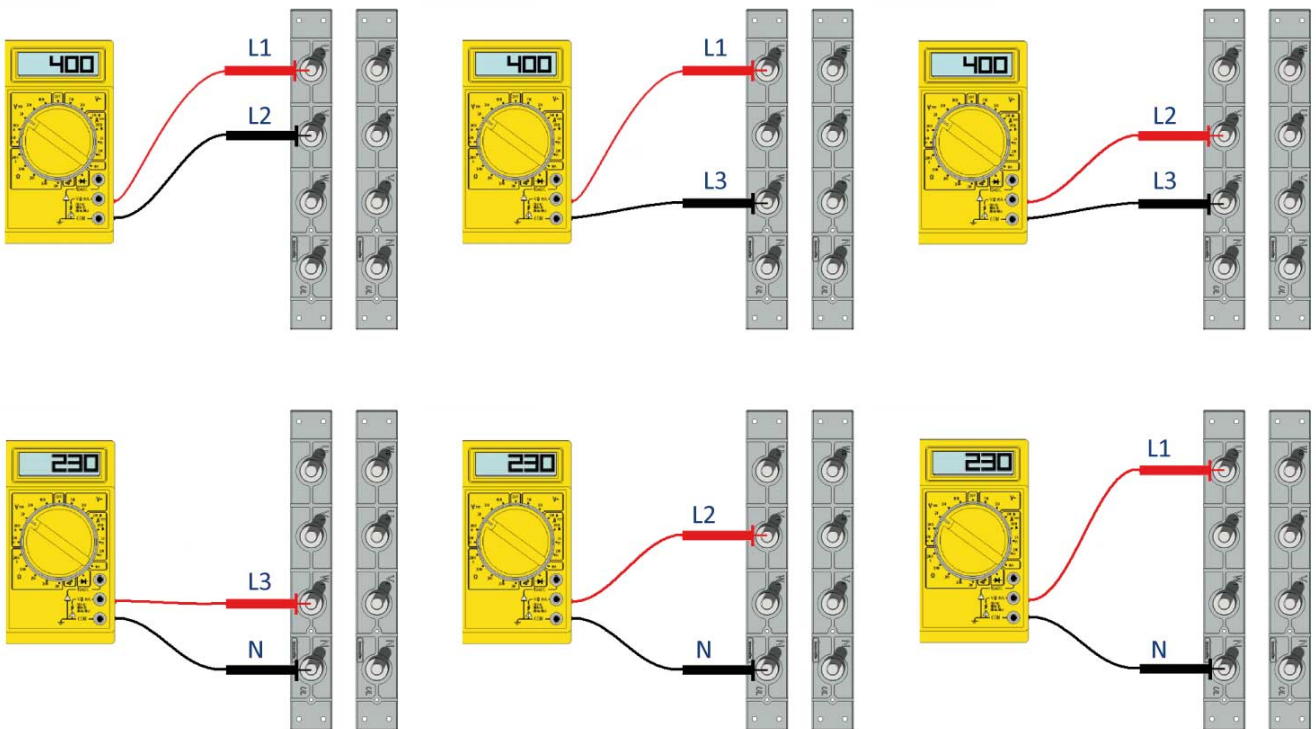

lay_ECO_003-r00

Use a multimeter to check all three phases (both L-L and L-N).

When off-load the voltage should be balanced on all three phases with a $\pm 1\%$ tolerance.

If the voltage is unbalanced, this indicates a problem in the main winding of the stator.

If instead the voltage is balanced on the three phases, then the winding of the stator does not have problems.

If the voltage is lower than 15% of the nominal voltage, there might be a problem with the regulator, in the rotating diode bridge or in the exciter winding.

9.5.14.1 Resistance/Continuity Test

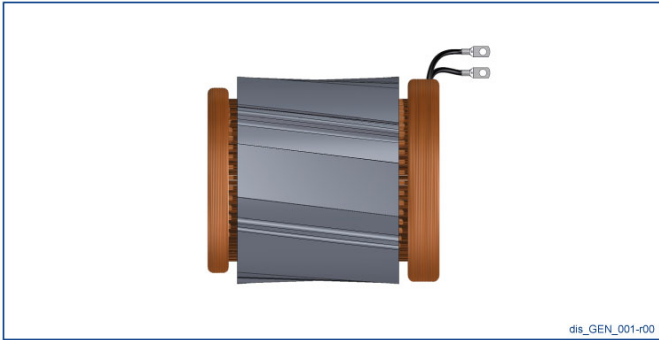

Main Stator

Use an appropriate tool to measure the phase resistance/continuity 1-2, 3-4, 5-6, 7-8, 9-10 and 11-12
Also check the resistance/continuity of the auxiliary winding between the two red wires coming out of the main stator.



For the values see paragraph 12.3.

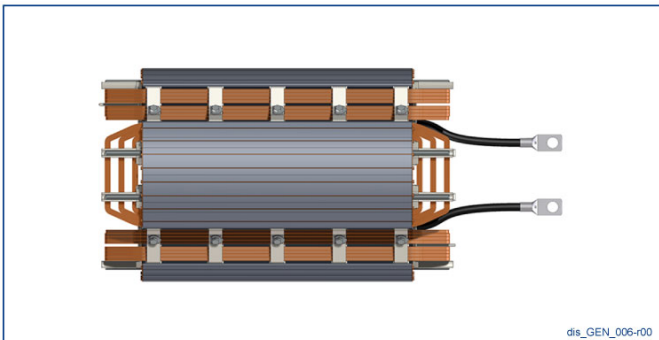

Main rotor

Measure the resistance/continuity of the main rotor using a multimeter.



For the values see paragraph 12.3.

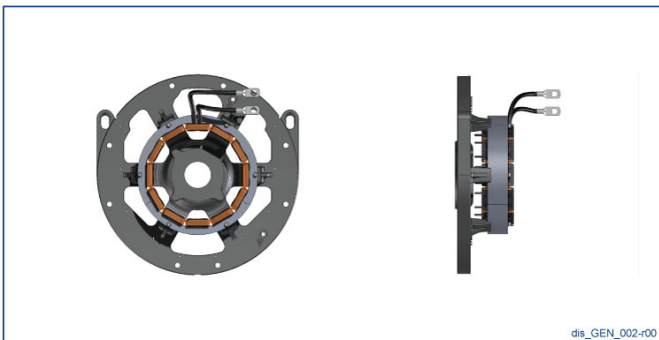

Exciter stator

Measure the resistance/continuity of the winding of the exciter stator between the positive wire (yellow) and the negative one (blue) with a multimeter.



For the values see paragraph 12.3.

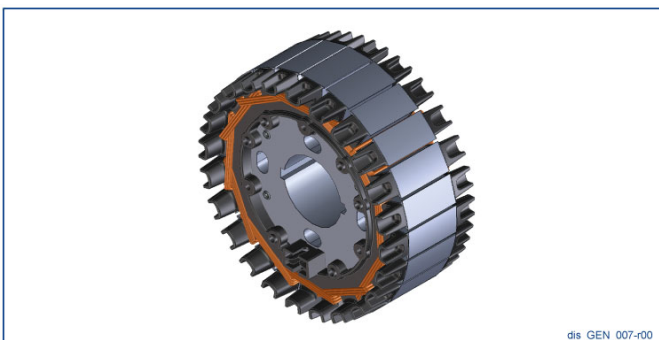

Exciter rotor

Measure the resistance/continuity of the winding of the exciter rotor between phases with a multimeter.



For the values see paragraph 12.3.

9.5.14.2 Insulation Test

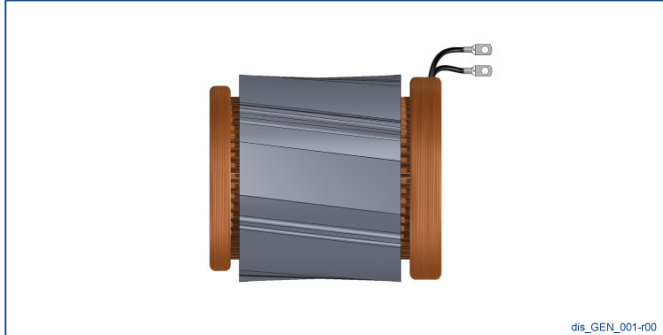

Main Stator

Completely disconnect the AVR and the connection between neutral and ground before performing this test.

The measurement must be carried out using an insulation tester (Megger) of 500 V.

Check the insulation between phases, between phases and ground, between auxiliary and phases and between auxiliary and ground.

i For these alternators, the minimum insulation value is of 1 MΩ.

If the insulation resistance is lower, the stator must be cleaned and, if necessary, impregnated or painted again with EG43 gray paint and then dried at 50-60 °C.

If after these operations the value remains low, the stator must be rewound or replaced.

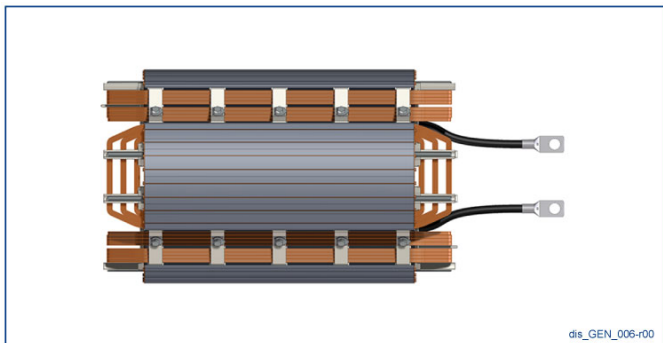

Main rotor

The insulation resistance is measured between phase and ground using an insulation tester (Megger).

i For these alternators, the minimum insulation value is of 1 MΩ.

If the insulation resistance is lower, the rotor must be cleaned and, if necessary, impregnated and then dried at 50-60 °C.

If after these operations the value remains low, the rotor must be rewound or replaced.

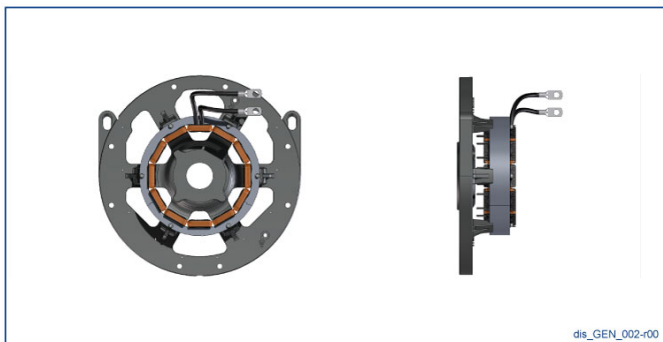

Exciter stator

The insulation resistance is measured between phase and ground using an insulation tester (Megger).

i For these alternators, the minimum insulation value is of 1 MΩ.

If the insulation resistance is lower, the stator must be cleaned and, if necessary, painted again with EG43 gray paint and then dried at 50-60 °C.

If after these operations the value remains low, then the stator must be rewound or replaced.

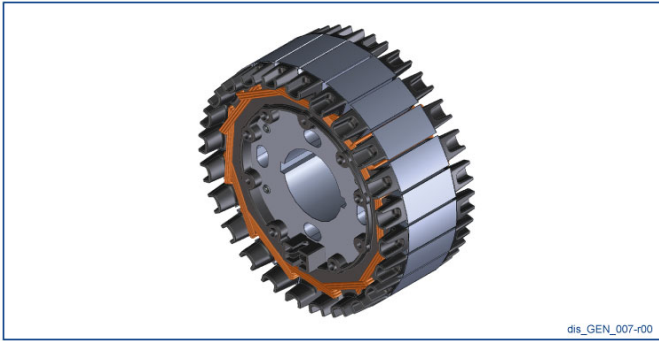

Exciter rotor

The insulation resistance is measured between phase and ground using an insulation tester (Megger).



For these alternators, the minimum insulation value is of 1 M Ω .

If the insulation resistance is lower, the rotor must be cleaned and, if necessary, impregnated and then dried at 50-60 °C.

If after these operations the value remains low, the rotor must be rewound or replaced.

9.6 General Tightening Torques

9.6.1 ECO38 Series

38 Series					
Application		Screw type		[Nm] ± 7% Tightening Torque	Replacement parts cat. reference
Cover rod	S	M12 X 496		100 ± 10%	28
	L	M12 X 705		100 ± 10%	
Fastening of 55 mm exciter stator (without PMG)		M8 X 70	CL. 8.8	25	10
Fastening of 55 mm exciter stator (with PMG)		M8 X 70	CL. 4.8	25	10
Fastening of exciter rotor		M8 X 30	CL. 8.8	21	163
IP2X protection of front cover		M5 X 30	CL. 4.8	3.3	39
Back Grid		M6 X 16	CL. 8.8	9	1
Terminal Block		M6 X 30	CL. 8.8	9	5
Fastening the terminal block to the frame		M6 X 16	CL. 8.8	9	
terminal box		M6 X 16	CL. 8.8	12	2, 95, 96, 97
Back cover ground wire		M10 X 20	CL. 8.8	48	7
Rotor bracket		M5 X 50	CL. 8.8	3.5	14
Fan fastening		M10 X 50	CL. 8.8	38	15
Regulator		M4 X 25	CL. 4.8	1	23
Diode bridge		M5 X 12	CL. 4.8	1.7	11
		M5 X 16	CL. 4.8	1.7	11
Flywheel					
Flywheel 11.5		M12 X 55	CL. 8.8	80	60
Flywheel 14		M12 X 30	CL. 8.8	80	60

38 Series				
Application	Screw type		[Nm] ± 7% Tightening Torque	Replacement parts cat. reference
Optional				
Fastening of paralleling device	M4 X 16	CL. 4.8	1	
Terminal block for paralleling device	M3 X 16	CL. 4.8	0.5	
Terminal block for accessories	M3 X 25	CL. 4.8	0.5	
Front IP45 air filter	M5 X 16	CL. 8.8	5	
Back IP45 air filter	M6 X 16	CL. 4.8	9	
PMG	M4 X 10	CL. 4.8	1.5	
	M8 X 90	CL. 8.8	25	
	M14 X 188		120 ± 10%	

9.6.2 ECO40 Series

40 Series					
Application		Screw type		[Nm] ± 7% Tightening Torque	Replacement parts cat. reference
Cover rod	S	M16 X 640		180 ± 10%	28
	L	M16 X 805		180 ± 10%	
Fastening of 70mm exciter stator		M8 X 90	CL. 8.8	25	10
IP2X protection of front cover		M5 X 25	CL. 4.8	3.3	39
Back Grid		M6 X 16	CL. 8.8	9	1
terminal box		M6 X 16	CL. 8.8	12	2, 95, 96, 97
Fastening the terminal block to the frame		M6 X 16	CL. 8.8	9	142
Weight on frame		M16 X 30	CL. 8.8	180 ± 10%	8
Rotor bracket		M8 X 70	CL. 8.8	18	14
Terminal Block		M6 X 35	CL. 8.8	9	5
Fan fastening		M10 X 50	CL. 8.8	40	15
Regulator		M4 X 25	CL. 4.8	1	23
Fastening of paralleling device		M4 X 16	CL. 4.8	1	
Paralleling device terminal block		M3 X 25	CL. 4.8	0.5	
Diode bridge		M5 X 25	CL. 4.8	3.3	11
		M5 X 20	Brass	3.3	11
		M5 X 25	Brass	3.3	11
Flywheel					
Flywheel 14		M16 X 45	CL. 8.8	200 ± 10%	60
Flywheel 18		M16 X 40	CL. 8.8	200 ± 10%	60

40 Series				
Application	Screw type		[Nm] ± 7% Tightening Torque	Replacement parts cat. reference
Optional				
Accessory terminal block	M3 X 25	CL. 4.8	0..5	
Front IP45 air filter	M5 X 16	CL. 8.8	5	
Back IP45 air filter	M6 X 16	CL. 8.8	9	
PMG	M5 X 10	CL. 4.8	5	
	M6 X 80	CL. 8.8	9	
	M8 X 100	CL. 8.8	25	
	M14 X 227		120 ± 10%	

9.6.3 ECO43 Series

43 Series				
Application	Screw type		[Nm] ± 7% Tightening Torque	Replacement parts cat. reference
Fastening of 80mm exciter stator	M8 X 100	CL. 8.8	25	10
Front Cover	M14 X 50	CL. 8.8	120 ± 10%	9
Back cover	M14 X 70	CL. 8.8	120 ± 10%	7
terminal box	M6 X 16	CL. 8.8	12	2, 95, 96, 97
Fastening the terminal block to the frame	M6 X 25	CL. 8.8	9	
IP2X protection of front cover	M5 X 25	CL. 4.8	3.3	39
Fastening terminals to bearing	M6 X 45	CL. 10.9	9	140
Fastening of cable terminals	M10 X 40	CL. 8.8	48	
Fastening bridge to terminals (phase L1, L2, L3)	M10 X 50	CL. 8.8	48	141
Fastening bridge to terminals (star point)	M10 X 60	CL. 8.8	48	141
3-plate terminal block support bracket	M6 X 25	CL. 8.8	9	139
Terminal board support bracket	M8 X 40	CL. 8.8	12	139
Back grease protection ring	M12 X 85	CL. 8.8	100 ± 10%	
Front grease protection ring	M6 X 80	CL. 8.8	9	
Back V-shaped closure	M6 X 16	CL. 8.8	9	94
Fastening of exciter rotor	M8 X 35	CL. 8.8	21	13
Fastening of balancing ring	M8 X 20	CL. 8.8	21	
Back cover ground wire	M16 X 30	CL. 8.8	180 ± 10%	7
Rotor bracket	M10 X 75	CL. 8.8	35	14
Regulator	M4 X 25	CL. 4.8	1	23
Fastening of paralleling device	M4 X 16	CL. 4.8	1	
Terminal block for paralleling device	M3 X 25	CL. 4.8	0.3	
Rotating diode bridge	M5 X 25	CL. 4.8	3.3	11
	M5 X 20	Brass	3.3	11
	M5 X 25	Brass	3.3	11

43 Series				
Application	Screw type		[Nm] ± 7% Tightening Torque	Replacement parts cat. reference
Flywheel				
Flywheel 14	M16 X 55	CL. 8.8	200 ± 10%	60
Flywheel 18	M16 X 40	CL. 8.8	200 ± 10%	60
Flywheel 21	M16 X 40	CL. 8.8	200 ± 10%	60
Optional				
Accessory terminal block	M3 X 25	CL. 4.8	0.5	
Front IP45 air filter	M5 X 16	CL. 4.8	3.3	
Back IP45 air filter	M6 X 16	CL. 8.8	9	
PMG	M5 X 10	CL. 4.8	3.3	
	M6 X 80	CL. 4.8	9	
	M8 X 100	CL. 8.8	25	
	M14 X 227		120 ± 10%	
Terminal block bridge for transformer	M10 X 40	CL. 8.8	48	
	M10 X 50	CL. 8.8	48	
	M10 X 60	CL. 8.8	48	
	M5 X 20	CL. 4.8	2	
	M6 X 30	CL. 8.8	9	

9.6.4 ECO46 Series

46 Series				
Application	Screw type		[Nm] ± 7% Tightening Torque	Replacement parts cat. reference
Fastening of 120mm exciter stator	M8 X 140	CL. 8.8	25	10
Front Cover	M14 X 70	CL. 8.8	120 ± 10%	9
Back cover	M14 X 70	CL. 8.8	120 ± 10%	7
terminal box	M6 X 16	CL. 8.8	12	2, 95, 96, 97
Fastening the terminal block to the frame	M6 X 25	CL. 8.8	9	
IP2X protection of front cover	M5 X 25	CL. 4.8	3.3	39
Fastening terminals to bearing	M6 X 45	CL. 10.9	9	140
Fastening of cable terminals	M10 X 40	CL. 8.8	48	
Fastening bridge to terminals (phase L1, L2, L3)	M10 X 50	CL. 8.8	48	141
Fastening bridge to terminals (star point)	M10 X 70	CL. 8.8	48	141
3-plate terminal block support bracket	M8 X 40	CL. 8.8	12	142
Terminal board support bracket	M8 X 35	CL. 8.8	12	142
Back grease protection ring	M6 X 85	CL. 8.8	9	
Front grease protection ring	M6 X 100	CL. 8.8	9	
Back V-shaped closure	M6 X 16	CL. 8.8	9	94
Fastening of exciter rotor	M8 X 35	CL. 8.8	21	13
Fastening of balancing ring	M8 X 20	CL. 8.8	21	
Back cover ground wire	M16 X 30	CL. 8.8	180 ± 10%	7
Rotor bracket (only 4 poles)	M10 X 80	CL. 8.8	43	14
Rotor bracket (only 6 poles)	M10 X 110	CL. 8.8	43	14
Regulator	M4 X 25	CL. 4.8	1	23
Fastening of paralleling device	M4 X 16	CL. 4.8	1	
Terminal block for paralleling device	M3 X 25	CL. 4.8	0.5	
Rotating diode bridge	M5 X 25	CL. 4.8	3.3	11
	M5 X 20	Brass	3.3	11
	M5 X 25	Brass	3.3	11

46 Series				
Application	Screw type		[Nm] ± 7% Tightening Torque	Replacement parts cat. reference
Flywheel				
Flywheel 18	M16 X 40	CL. 8.8	200 ± 10%	60
Flywheel 21	M16 X 40	CL. 8.8	200 ± 10%	60
Optional				
Accessory terminal block	M3 X 25	CL. 4.8	0.5	
Front IP45 air filter	M6 X 20	CL. 8.8	9	
Back IP45 air filter	M6 X 16	CL. 8.8	9	
PMG	M5 X 10	CL. 4.8	3.3	
	M6 X 80	CL. 4.8	9	
	M8 X 150	CL. 8.8	25	
	M14 X 267		120 ± 10%	
Terminal block bridge for transformer	M10 X 40	CL. 8.8	48	
	M10 X 50	CL. 8.8	48	
	M10 X 70	CL. 8.8	48	
	M5 X 20	CL. 4.8	2	
	M6 X 30	CL. 8.8	9	

9.7 Disc Tightening Torques

In case of replacement of discs, the appropriate tightening torques are indicated here (fastening discs to hub).

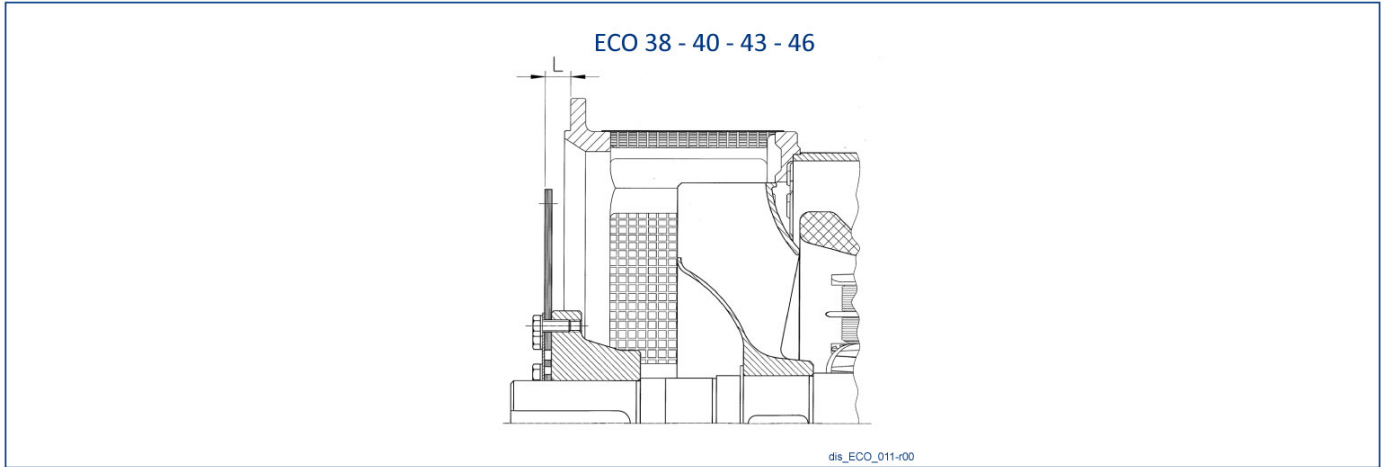

Type	SAE	L	Screw size		Tightening Torques (Nm)	
			TE	TCCEI	CL. 8.8	CL. 12.9
ECO38	11 ½	39,6	M12x45-8.8	/	80 ± 7%	/
	14	25,4	M12x30-8.8	/	80 ± 7%	/
ECO40	14	25,4	M16x45-8.8	/	200 ± 10%	/
	18	15,7	M16x40-8.8	/	200 ± 10%	/
ECO43	14	25,4	M16x55-8.8	/	200 ± 10%	/
	18	15,7	M16x40-8.8	/	200 ± 10%	/
	21	0	M16x40-8.8	/	200 ± 10%	/
ECO46	18	15,7	M16x40-8.8	/	200 ± 10%	/
	21	0	M16x40-8.8	/	200 ± 10%	/

9.8 Terminal block Tightening Torques

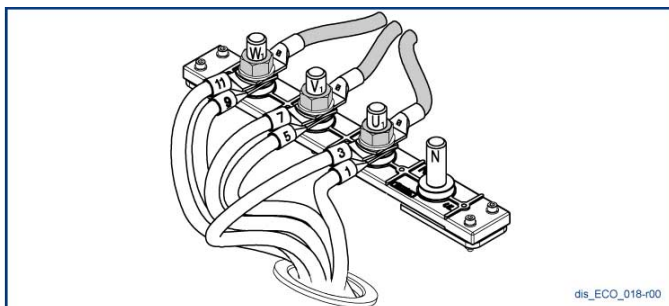

THREAD DIAMETER Df	TYPE	TIGHTENING TORQUE (Nm)
M10 (Steel)	ECO43 ECO46	48 ± 7%
M16	ECO38	80 ± 7%
M20	ECO40	100 ± 7%

10 DSR / DER1 alarm management

The state of the active alarms is visualized at location 38 that may be read through USB.

The index of the bits that present value 1 correspond to an active alarm.

If the regulator is working regularly (no active alarm) the B11 bit will result active.

N.	Event description	Action
1	EEprom Checksum	Restoring default data, Block
2	Overtoltage	APO
3	Undervoltage	APO
4	Short circuit	APO, Maximum current, Block
5	Excitation Overcurrent	APO, Reduction of Excitation Current
6	Low speed	APO, V/F Ramp
7	Overspeed	APO
8	Underexcitation /loss of excitation	APO

During normal operation a LED indicator mounted on the card flashes with a 2 second period and 50% duty cycle.

In case of intervention or signaling of any alarm there are different flashing modes available, as shown in the figure below.

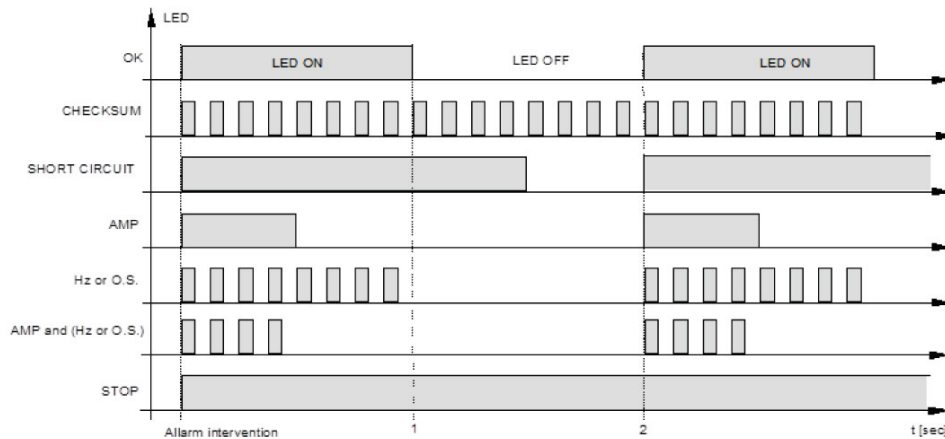

dis_ECO_012-r00

10.1 DSR/DER1 digital regulator alarms

ALARM DESCRIPTION		
N.	Event description	Action
1	Erroneous EEPROM control code	It is checked on start (after the DSP reset and the launch of the peripheral devices). The actions taken are: signaling, loading default settings, saving in EEPROM and blocking the regulator. Upon restart, if EEPROM is faulty, the alarm will be repeated, otherwise the regulator will start to operate on default parameters.
2	Overvoltage	The alarm does not determine a change in the LED flash, enables APO output and is memorized. It may be caused either by anomalous operating conditions (such as overspeed or capacitive load) or by any fault in the regulator. The overvoltage alarm is activated only if the angle has already been reduced to zero and, therefore, output voltage control has been lost. Overvoltage is calculated using an appropriate window, based on the speed and it is inhibited during the transients, for 2 sec. In the calculation window the threshold is set to 5% above the nominal value.
3	Undervoltage (@ ωN)	The alarm does not determine a change in the LED flash, enables APO output and is memorized. Undervoltage is calculated using an appropriate window based on the speed (visible in the undervoltage alarm description), the threshold is set to 5% under the nominal value; it intervenes only above the intervention threshold of the low speed alarm, it basically is inhibited by it. It is also inhibited in case of intervention of the "excitation overcurrent" alarm and during transients.
4	Short circuit	The alarm is disabled under 20Hz and visualized and memorized when action is activated. Tolerated short circuit time goes from 0.1 to 25,5 seconds (programmable in 100ms steps); then the regulator, after having saved DD and TT, turns to block mode and signals the STOP status. With the "short circuit time" parameter set to zero, the block is disabled. The reduction of the angle may cause an excitation drop, with a consequent stop and subsequent restart of the regulator and then the cycle is repeated.
5	Excitation Overcurrent	This alarm's function is not only to signal a state of excess accumulation of heating of the exciter, but also an active function of elimination of the cause. There is in fact a regulation ring that takes over after a threshold is exceeded; the action determines the reduction of the excitation current and then of the output voltage. The available parameter is the "threshold", which determines, in the end, the balance value at which the system stabilizes. The alarm is signaled and memorized. For the adjustment see paragraph "Excitation overcurrent".
6	Low speed	(Immediate) Signaling and activation of the V/F ramp. This alarm also appears at start and at stop. The alarm does not trigger data saving in EEPROM. The alarm intervention threshold depends on the 50/60 jumper status (hardware or software) and on the Hz trimmer position or on the value of parameter 21. Under the threshold the V/F ramp is present.

ALARM DESCRIPTION		
N.	Event description	Action
7	Overspeed	It is visualized similarly to the low speed alarm, it does not trigger actions on control and it is memorized. The overspeed condition may cause, as in the case of capacitive load, an overvoltage. The threshold may be set through parameter 26.
8	Underexcitation /loss of excitation	The alarm does not determine a change in the LED flash, enables APO output and is memorized. The alarm condition is recognized by a underexcitation / loss of excitation observer, available for reading at location L[56]: if the value of L[56] is higher than the upper (fixed) threshold or lower than the value of the lower threshold (parameter P[27]), A-08 is activated. The alarm is inhibited during transients.

11 Problems, causes and solutions

Defect	Cause	Remedies
The alternator does not excite.	Faulty fuse.	Check the fuse and if necessary replace it.
	Faulty diodes.	Check the diodes and if necessary replace them (see paragraph 9.5.2).
	Speed too low (lower than nominal speed).	Adjust the speed to the nominal value.
	Residual magnetism too low.	Adjust the speed to the nominal value.
The alternator de-excites after excited state.	Connection cables damaged or disconnected.	Check the state and correct fastening of cables. Check the correct connection of cables using the attached drawings.
At no load low voltage	Regulator is not adjusted.	Readjust the voltage and/or stability. (see paragraph 8.1.1 and 8.2.1).
	Faulty regulator.	Replace the regulator.
	Speed lower than nominal speed.	Check the number of rotations.
	Damaged windings.	Check windings. (see paragraph 9.5.14 and 9.5.6).
At no load voltage is too high.	Regulator is not adjusted.	Readjust the voltage and/or stability. (see paragraph 8.1.1 and 8.2.1).
	Faulty regulator.	Replace the regulator.
At load, voltage is lower than nominal voltage.	Regulator is not adjusted.	Readjust the voltage and/or stability. (see paragraph 8.1.1 and 8.2.1).
	Faulty regulator.	Replace the regulator.
	Current is too high, $\cos \phi$ lower than 0.8, speed lower than 4% nominal speed.	Operating outside the standard parameter range. Adjust the alternator back to standard parameters.
	Faulty diodes.	Check the diodes and if necessary replace them (see paragraph 9.5.2).
At load, voltage is higher than nominal voltage.	Regulator is not adjusted.	Readjust the voltage and/or stability. (see paragraph 8.1.1 and 8.2.1).
	Regulator is not adjusted.	Replace the regulator.

Defect	Cause	Remedies
Unstable voltage.	Instability of the drive motor rotation speed.	Check uniformity of the drive motor rotation speed.
	"STAB" potentiometer of the regulator not adjusted.	Adjust stability of the regulator by turning the "STAB" potentiometer. (see paragraph 8.1.1 and 8.2.1).
High bearing temperature.	Scarce or too much bearing lubrication.	Check amount of grease (see paragraph 9.4.1).
	Damaged bearing.	Replace the bearing (see paragraph 9.5.8).
	Shaft Misalignment.	Check alignment (see paragraph 5.3.2).
Temperature of cooling air is high.	Ambient temperature is high.	Check the ventilation in the room to ensure correct temperature.
	Air backflow towards the machine.	Check for presence of obstructions around the machine.
	Aspiration of obstructed area.	Check the air vents.
	Heat source nearby the air vents.	Move heat source or machine.
	Air filter is clogged.	Clean or replace the air filter (see paragraph 9.3.2).
Vibration	Damaged bearings.	Replace bearings (see paragraph 9.5.8).
	Unbalancing/break of cooling fan.	Check/replace cooling fan (see paragraph 9.5.1).
	Inefficient base-attachment system.	Check attachment system.
	Misalignment between alternator and drive motor.	Check alignment between alternator and drive motor (see paragraph 5.3.2).



For any other anomaly please contact the reseller, in the authorized service centers or directly at Mecc Alte.

12 Electrical diagrams

Regulator type	Connection	Drawing No.
DSR	12 terminals - single-phase reference	SCC0062
DSR	12 terminals - single-phase reference	SCC0063
DSR	12 terminals - single-phase reference	SCC0064
DER1/DER2	12 terminals - single-phase reference	SCC0161
DER1/DER2	12 terminals - single-phase reference	SCC0160
DER1/DER2	12 terminals - three-phase reference	SCC0159
DER1/DER2	12 terminals - three-phase reference	SCC0158
DER1/DER2	12 terminals - single-phase reference ECO40	SCC0298
DER1/DER2	12 terminals - single-phase reference ECO40	SCC0296
DER1/DER2	12 terminals - three-phase reference ECO40	SCC0297
DER1/DER2	12 terminals - three-phase reference ECO40	SCC0295
DER1/DER2	12 terminals - single-phase reference	SCC0202
DER1/DER2	12 terminals - ZIG-ZAG connection, single-phase reference	SCC0203
DSR	12 terminals - with PMG, single-phase reference	SCC0155
DER1/DER2	12 terminals - with PMG, single-phase reference	SCC0231
DER1/DER2	12 terminals - with PMG, single-phase reference	SCC0232
DER1/DER2	12 terminals - with PMG, three-phase reference	SCC0234
DER1/DER2	12 terminals - with PMG, three-phase reference	SCC0235
SR7	6 terminals - single-phase reference	A2544
UVR6	6 terminals - single-phase reference	A2550
SR7	12 terminals - single-phase reference	A2545
UVR6	12 terminals - single-phase reference	A2549
UVR6	6 terminals - three-phase reference	A2548
UVR6	12 terminals - three-phase reference	A2552
SR7	12 terminals - ZIG-ZAG connection, single-phase reference	SCC0055
UVR6	12 terminals - ZIG-ZAG connection, single-phase reference	SCC0054

12.1 DSR digital regulator electrical diagrams

SCC0062: Alternators with 12 terminals with reference on half phase from 70 V to 140 V.

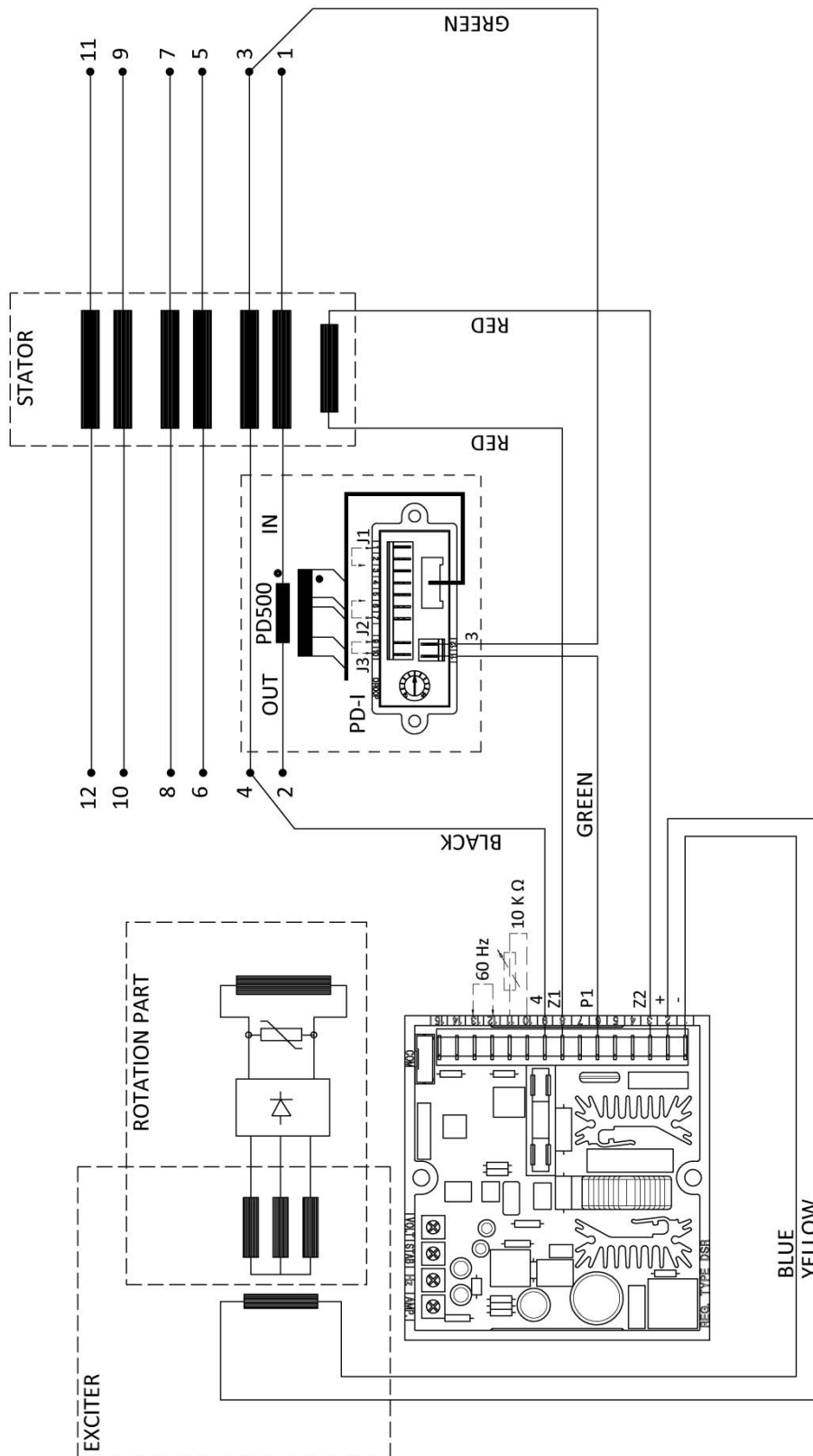

sd1_SCC0062-00_001-r00

SCC0063: Alternators with 12 terminals for star or delta connections, reference on the entire phase from 140 V to 280 V.

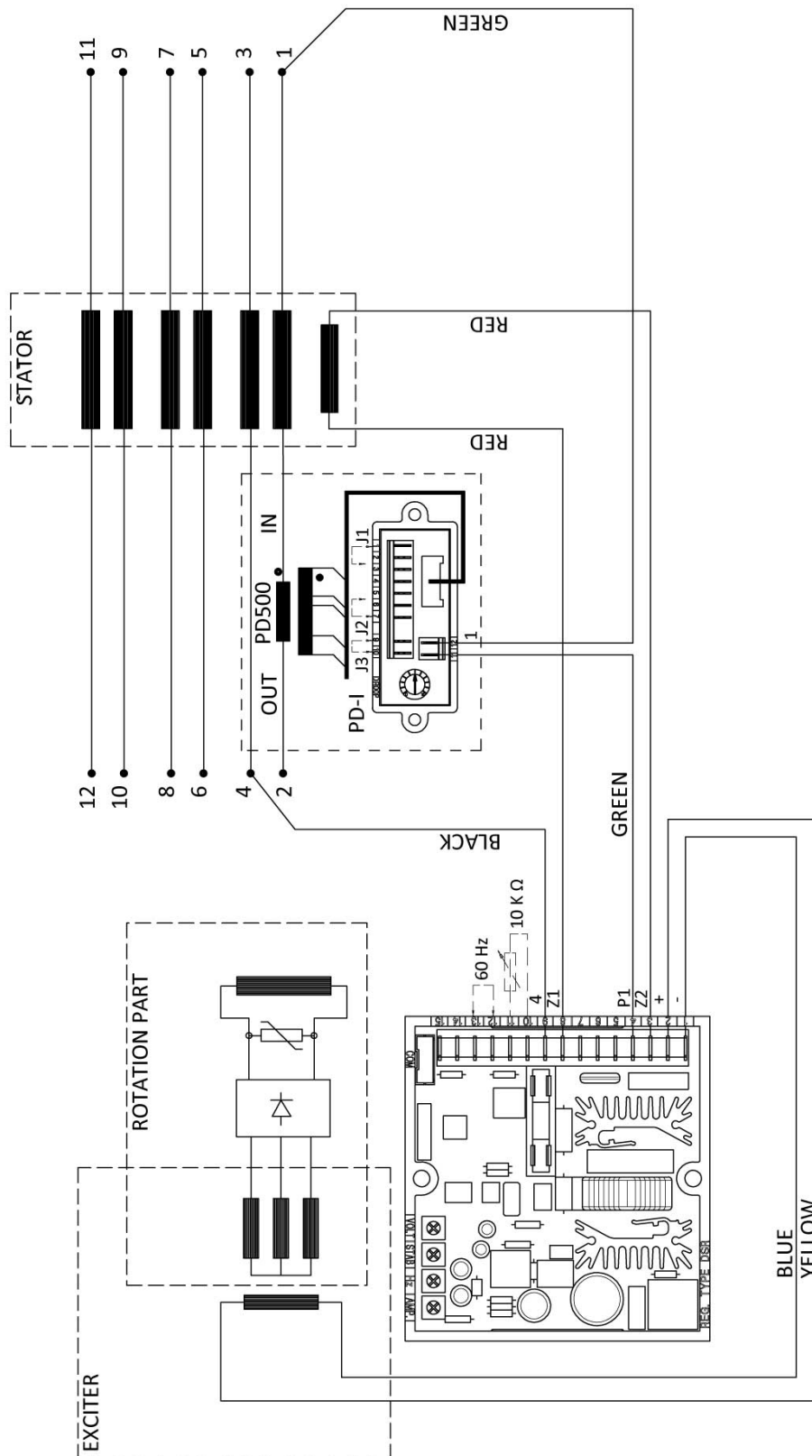

sch_SCC0063-03_001-00

SCC0064: Alternators with 12 terminals with reference on half phase from 140 V to 280 V.

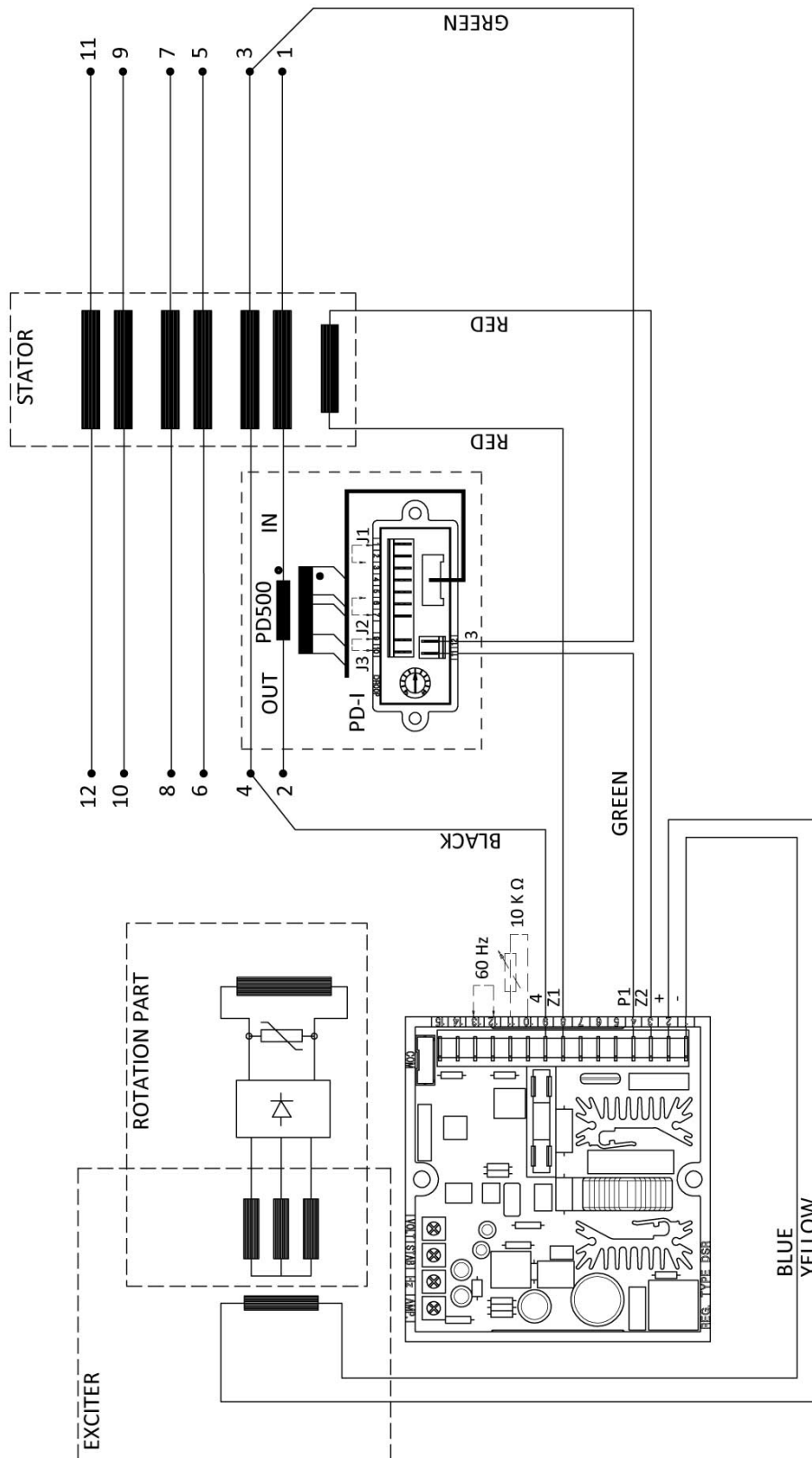

sch_SCC0064-03_001-00

12.2 DER 1 digital regulator electrical diagrams

SCC0161: Alternators with 12 terminals, 150 V - 300 V single-phase sensing.

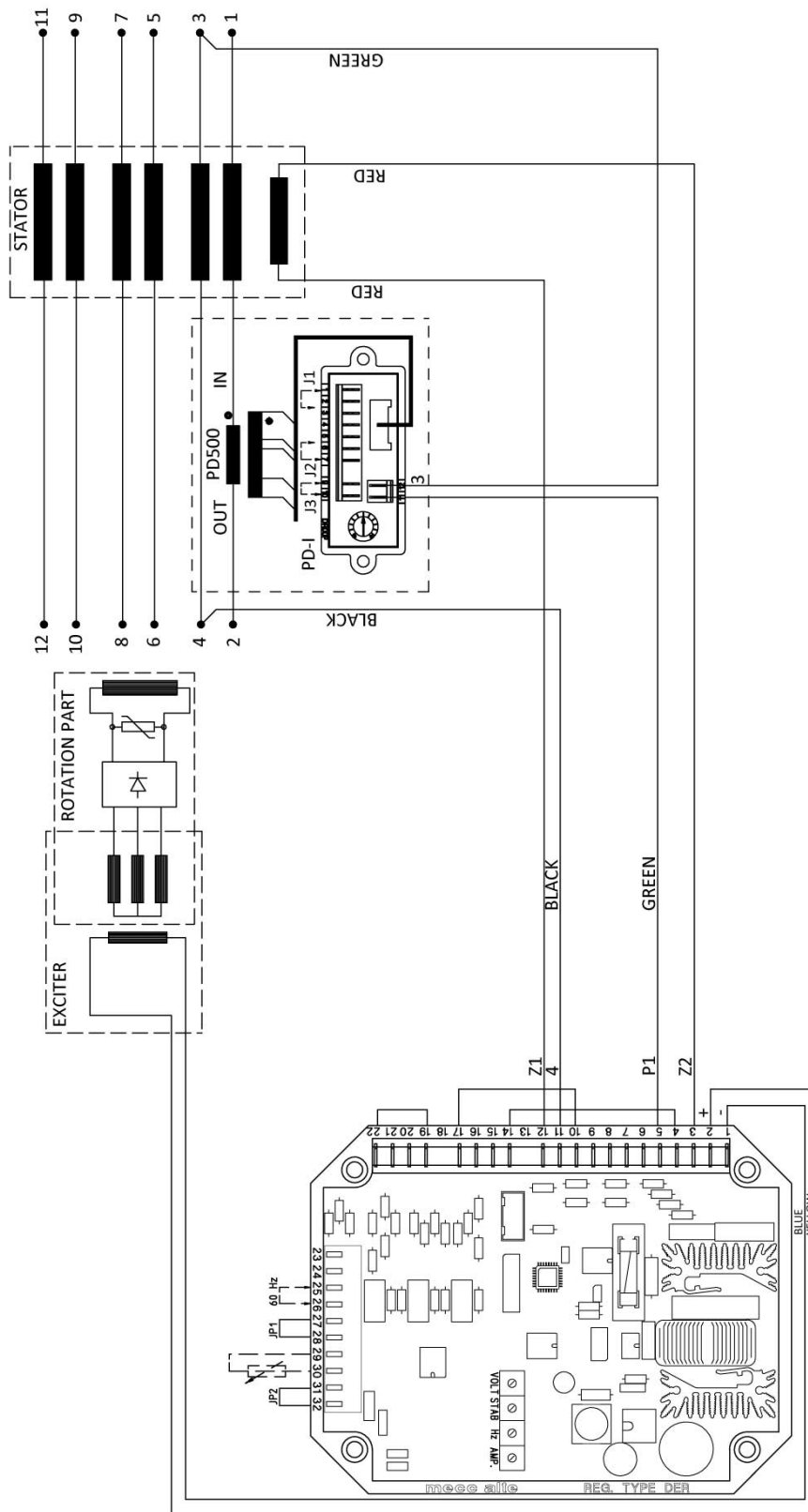

sch_SCC0161-03_001-r00



The electric scheme is valid also in case of use of the DER2 regulator instead of the DER1 regulator, represented in the scheme

SCC0159: Alternators with 12 terminals, three-phase reference from 150 V to 300 V.

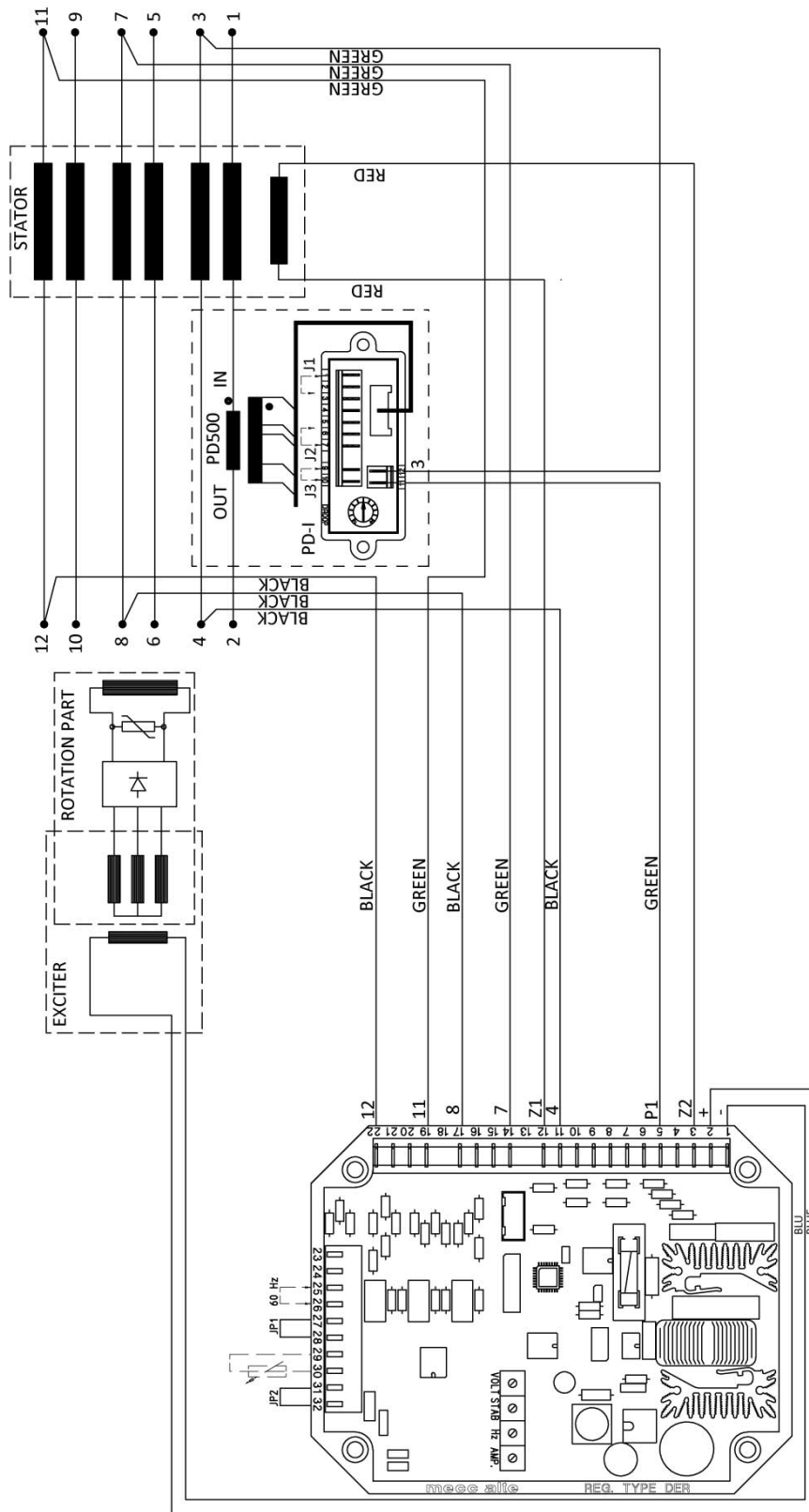

scr_SCC0159-05_001-r00



The electric scheme is valid also in case of use of the DER2 regulator instead of the DER1 regulator, represented in the scheme

SCC0158: Alternators with 12 terminals, three-phase reference from 75 V to 150 V.

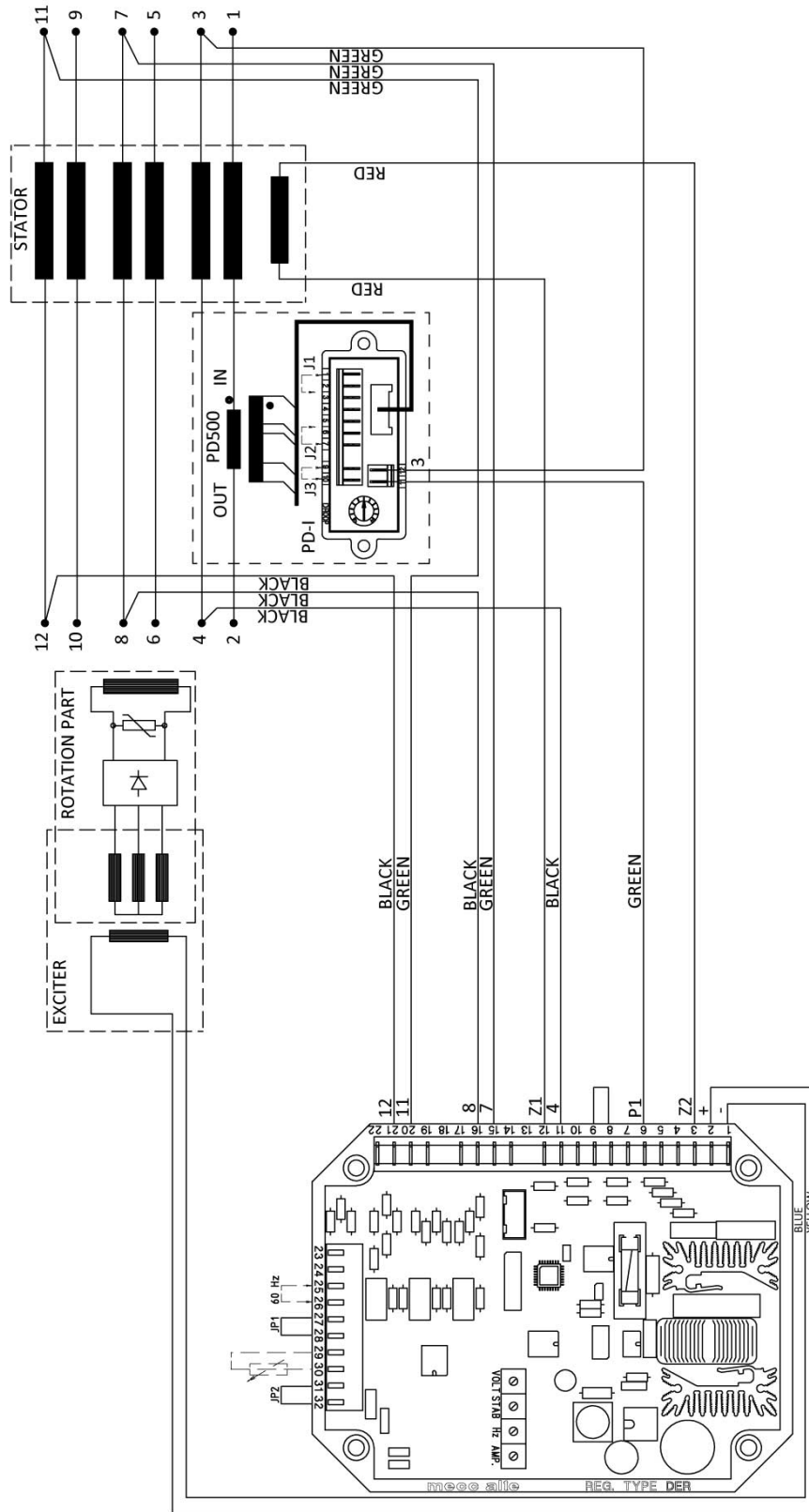

ser_SCC0158-05_001-r00



The electric scheme is valid also in case of use of the DER2 regulator instead of the DER1 regulator, represented in the scheme

SCC0298: ECO40 series alternators with 12 terminals, single-phase reference from 150 V to 300 V.

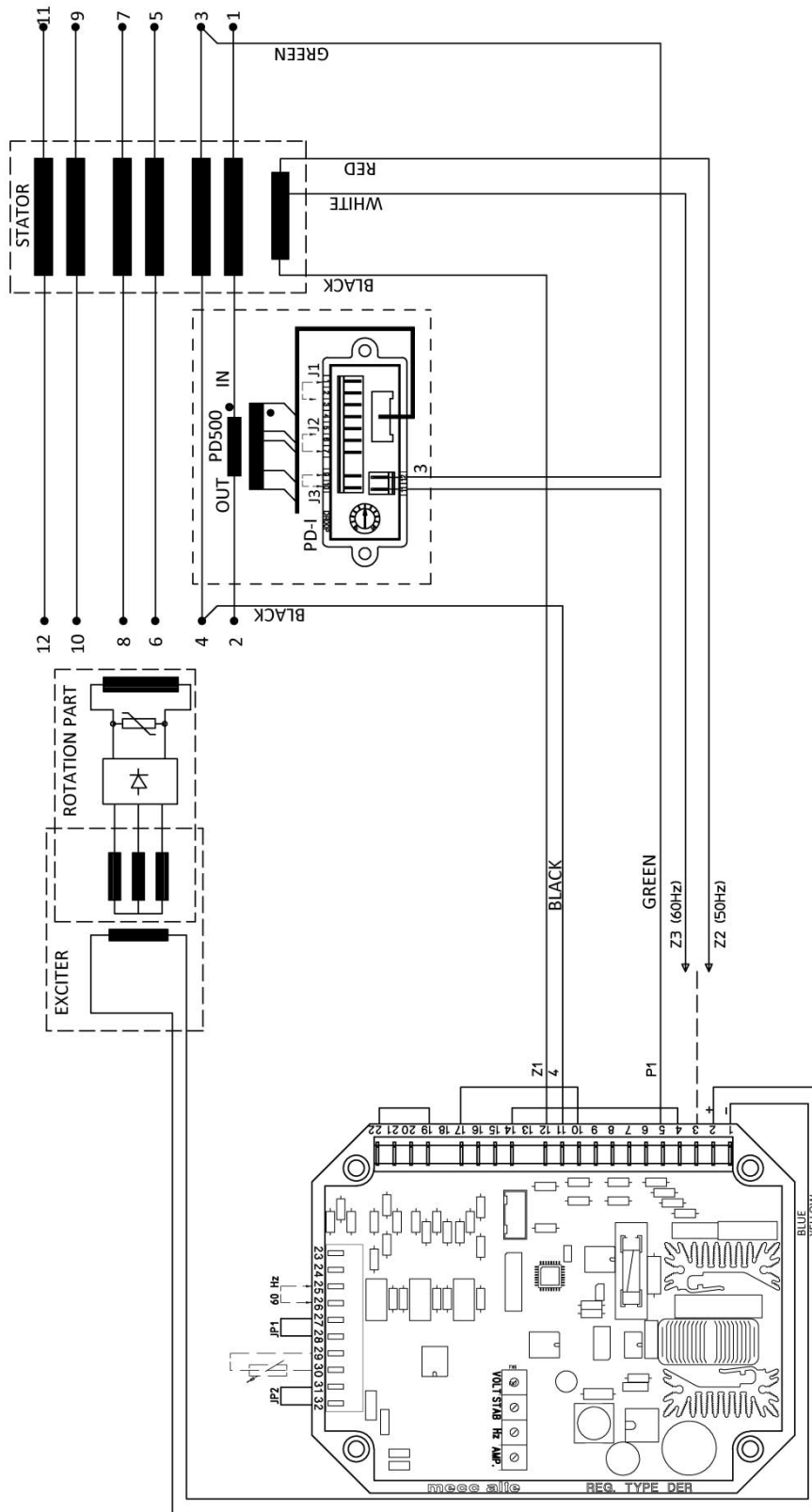

sch_SCC0298-00_001-r00



The electric scheme is valid also in case of use of the DER2 regulator instead of the DER1 regulator, represented in the scheme

SCC0296: ECO40 series alternators with 12 terminals, single-phase reference from 75 V to 150 V.

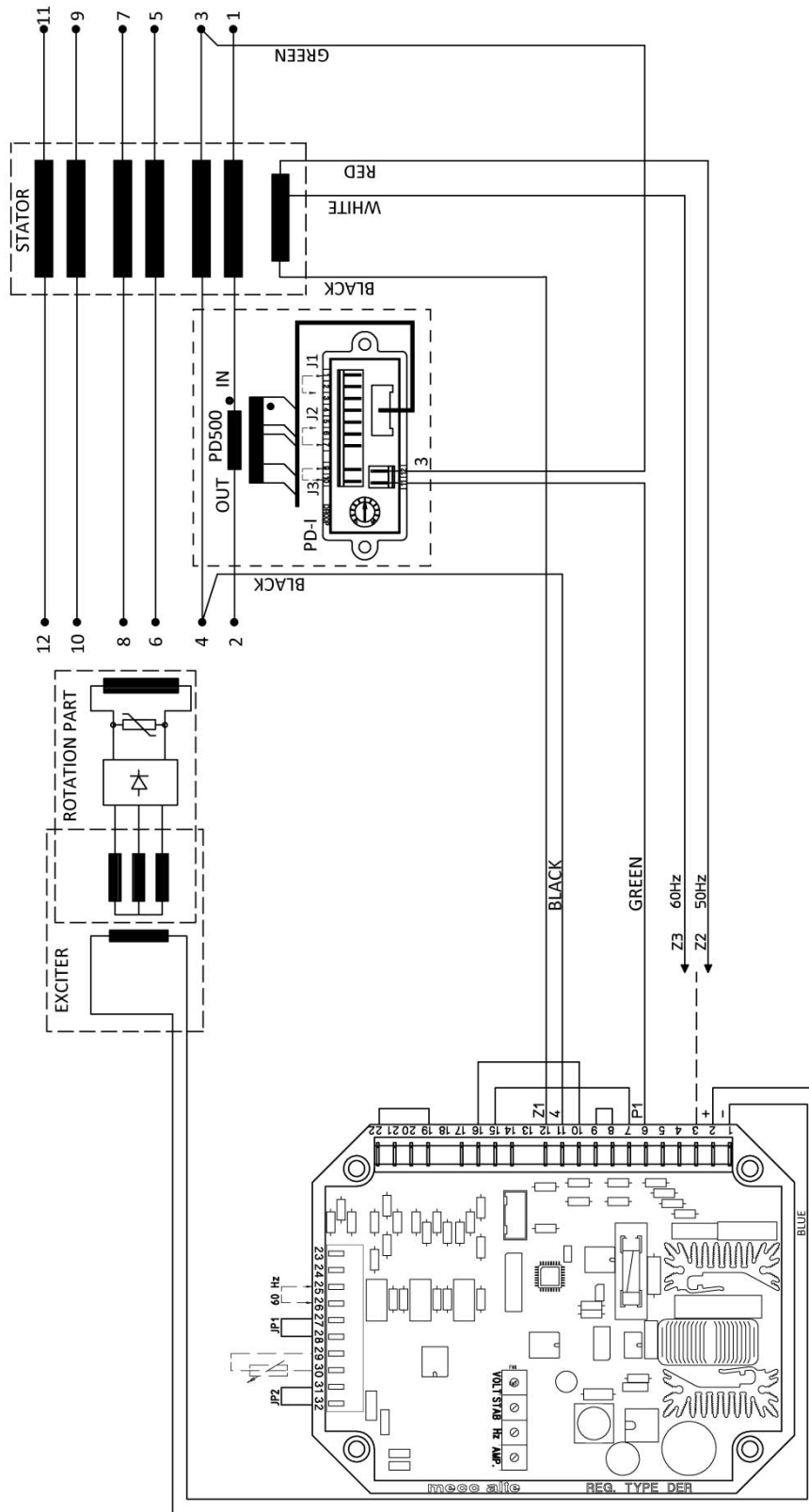

sch_SCC0296-02_001-r00



The electric scheme is valid also in case of use of the DER2 regulator instead of the DER1 regulator, represented in the scheme

SCC0297: ECO40 series alternators with 12 terminals, three-phase reference from 150 V to 300 V.

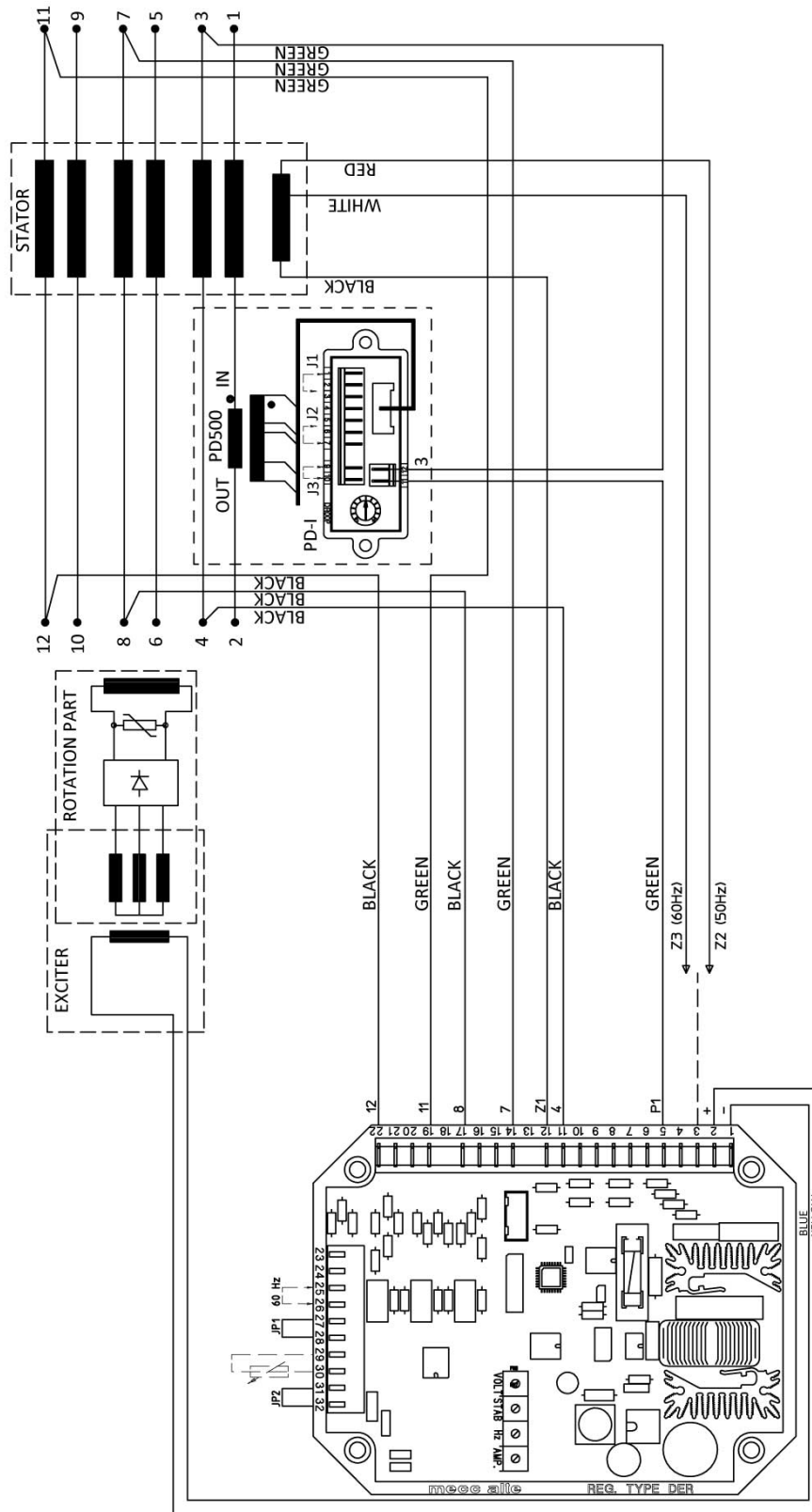

sch_SCC0297-00_001-r00



The electric scheme is valid also in case of use of the DER2 regulator instead of the DER1 regulator, represented in the scheme

SCC0295: ECO40 series alternators with 12 terminals, three-phase reference from 75 V to 150 V.

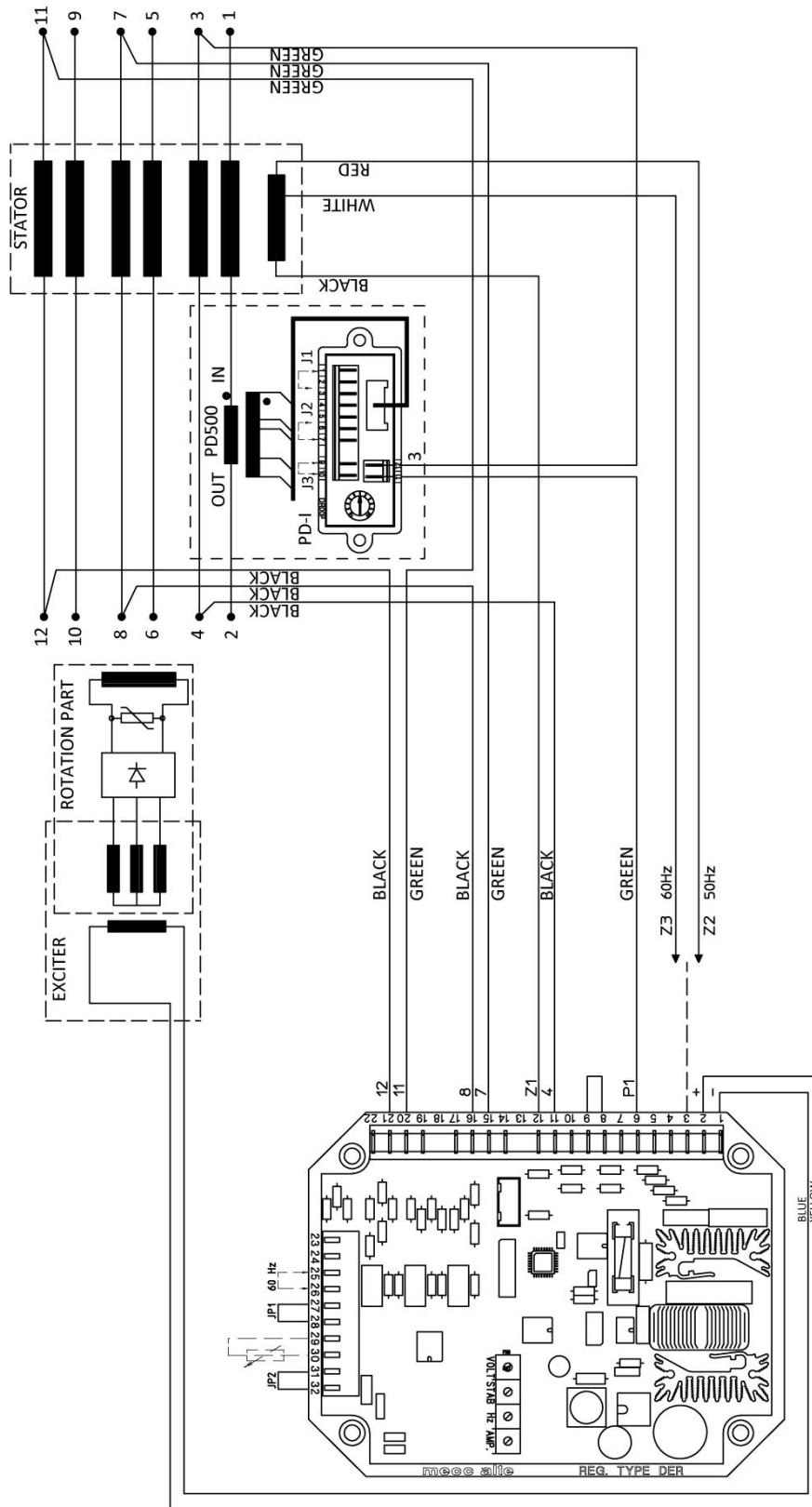

sch_SCC0295-01_001-r00



The electric scheme is valid also in case of use of the DER2 regulator instead of the DER1 regulator, represented in the scheme

SCC0202: Alternators with 12 terminals, single-phase reference from 300 V to 600 V.

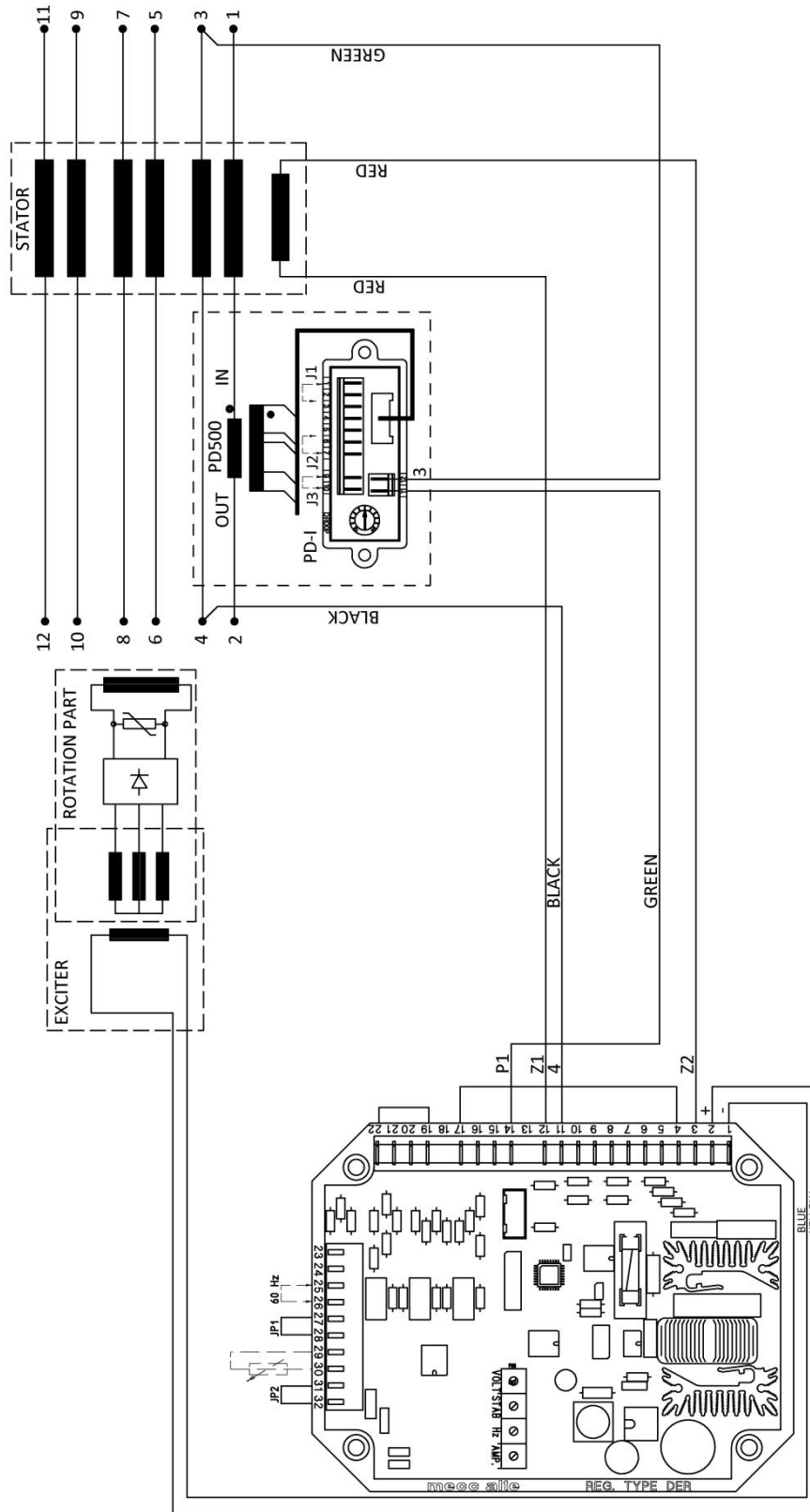

ser_SCC0202_01_001-r00



The electric scheme is valid also in case of use of the DER2 regulator instead of the DER1 regulator, represented in the scheme

SCC0203: Alternators with 12 terminals, ZIG-ZAG connection, single-phase reference from 300 V to 600 V.

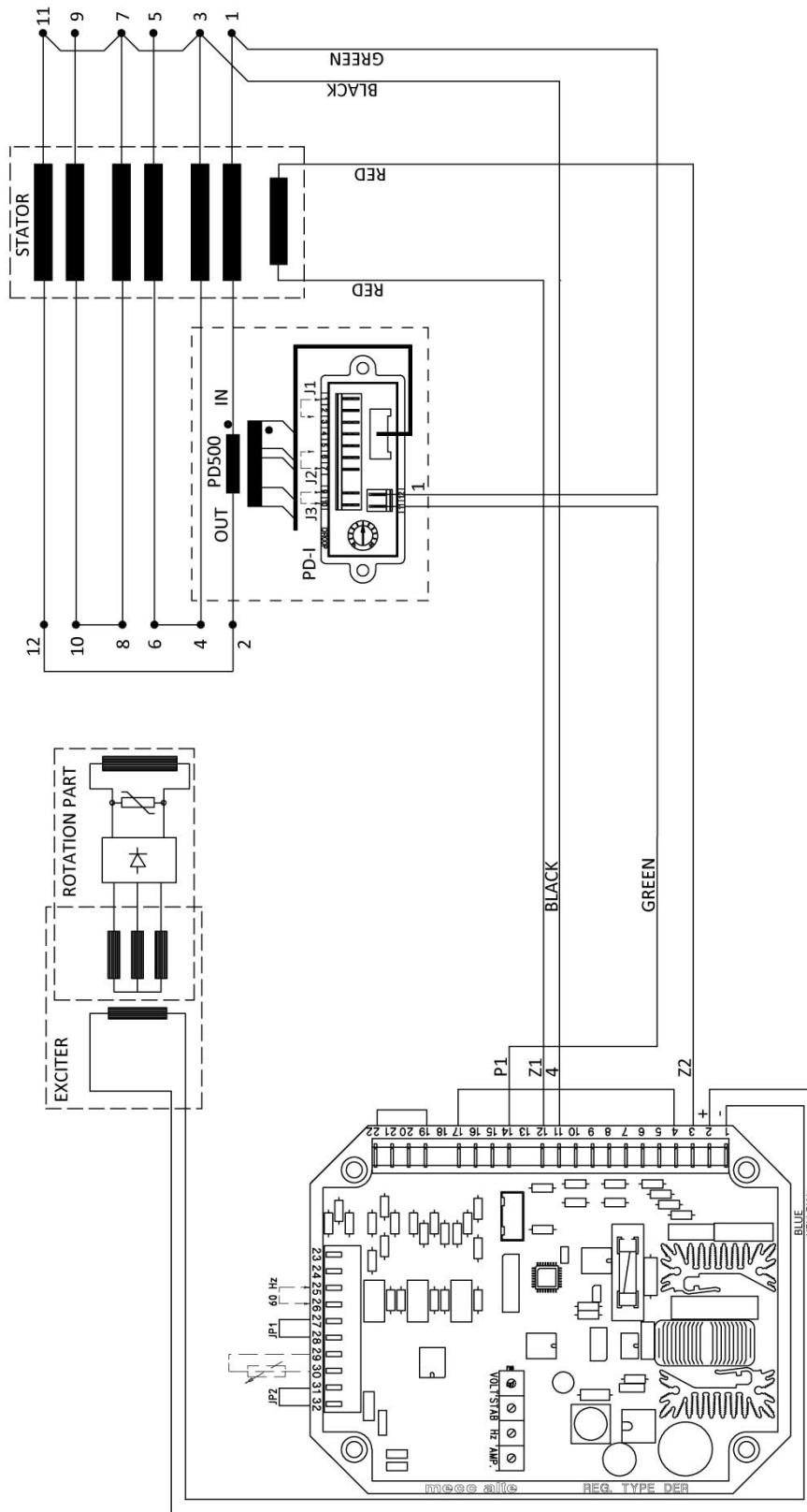

ser_SCC0203-01_001-r00



The electric scheme is valid also in case of use of the DER2 regulator instead of the DER1 regulator, represented in the scheme

12.3 Electrical diagrams with PMG

SCC0155: Alternators with 12 terminals, with PMG, DSR regulator. (Terminal 4: reference from 140V to 280V, terminal 6: reference from 70V to 140V).

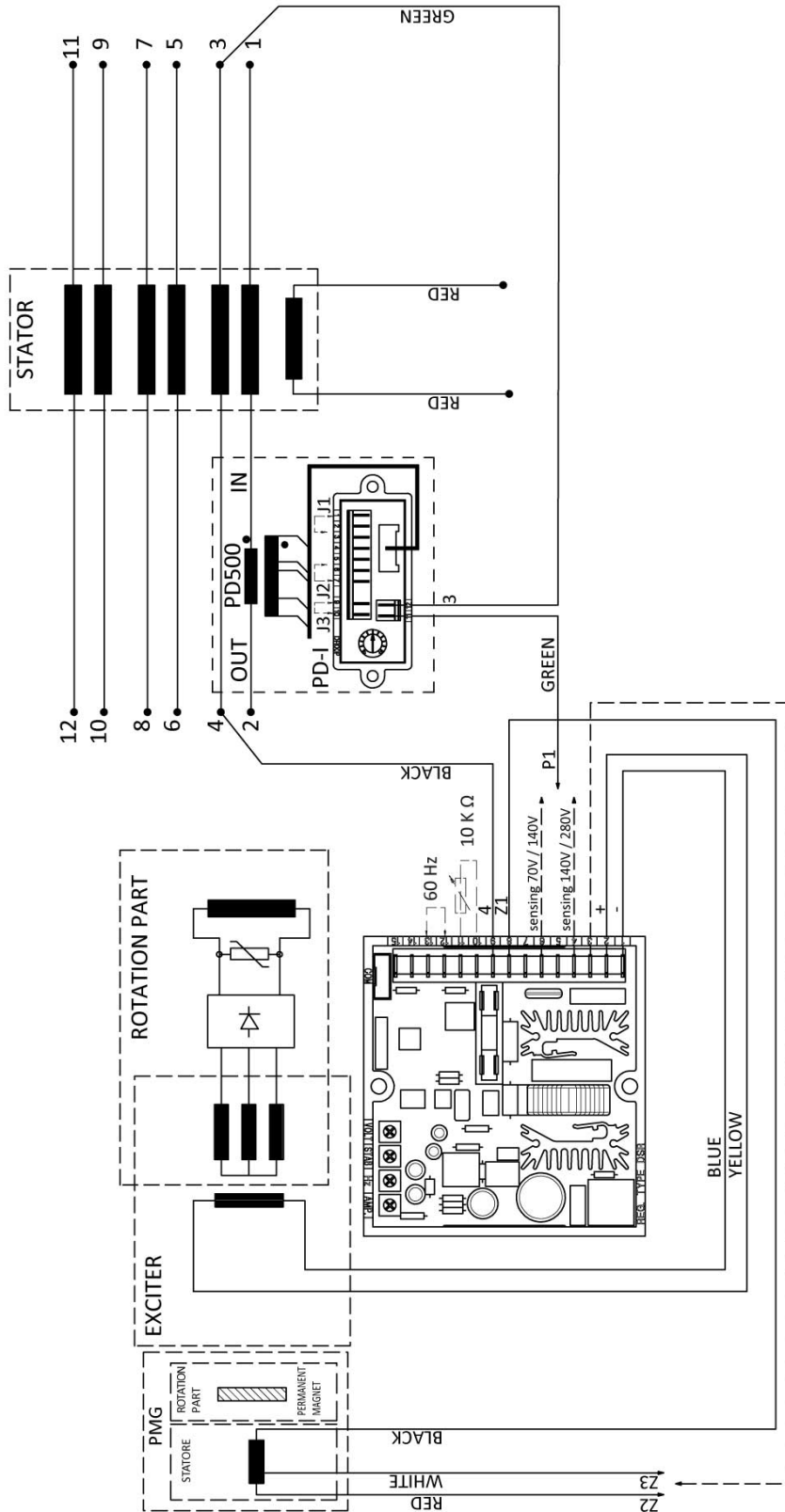

sch_SCC0155-01_001-r00

SCC0231: Alternators with 12 terminals, with PMG, DER1 regulator, single-phase reference from 75V to 150V.

sch_SCC0231-01_001-r00

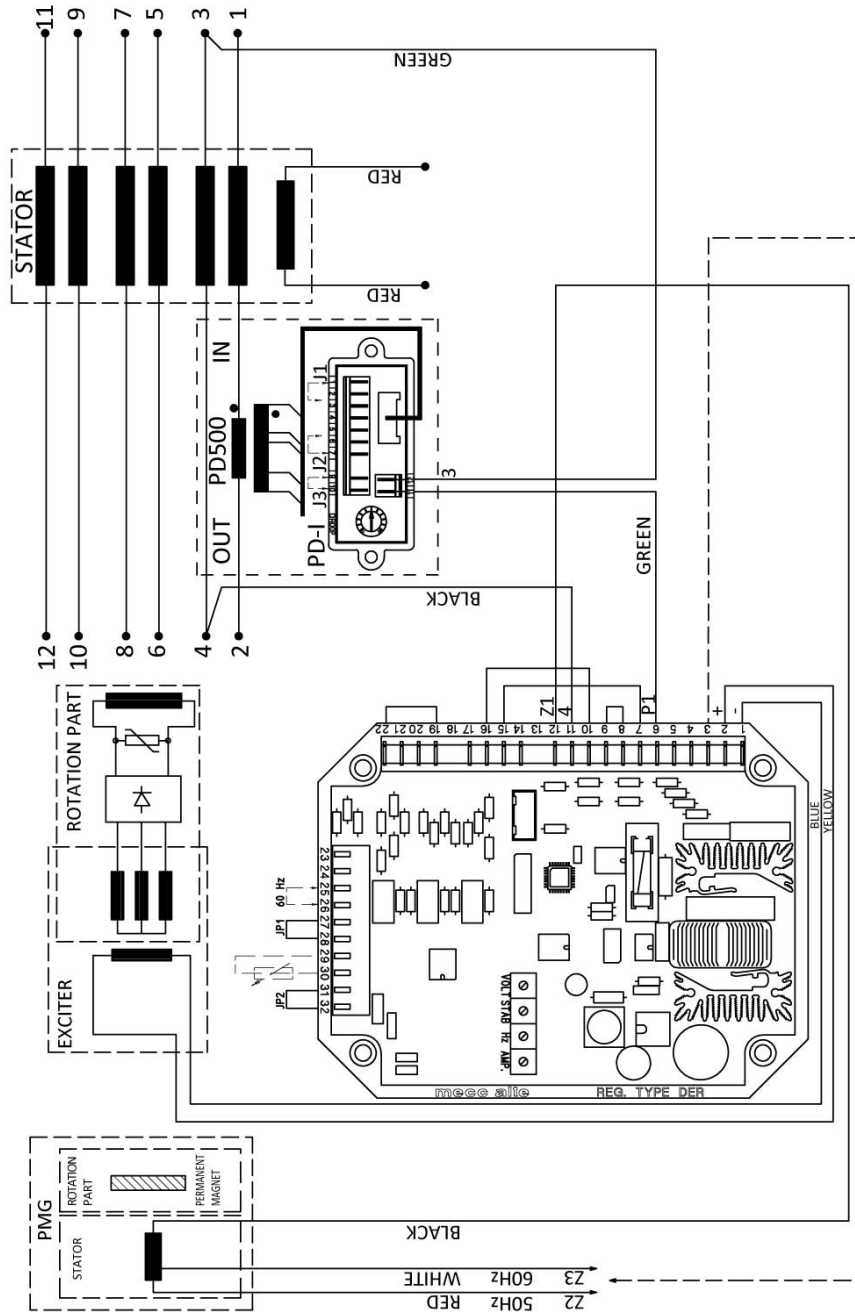

The electric scheme is valid also in case of use of the DER2 regulator instead of the DER1 regulator, represented in the scheme

SCC0232: Alternators with 12 terminals, with PMG, DER1 regulator, single-phase reference from 150V to 300V.

sch_SCC0232-01_001-r00

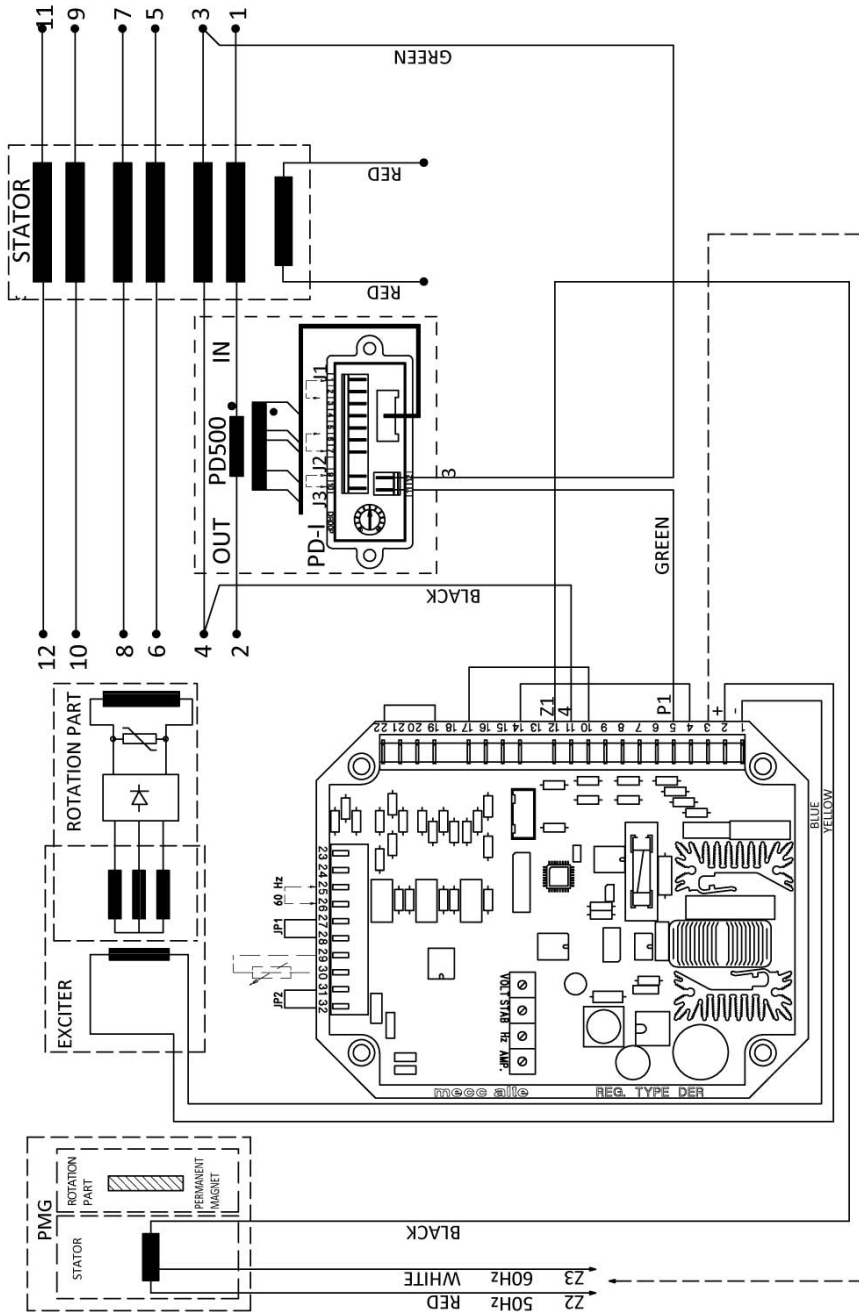

The electric scheme is valid also in case of use of the DER2 regulator instead of the DER1 regulator, represented in the scheme

SCC0234: Alternators with 12 terminals, with PMG, DER1 regulator, three-phase reference from 75V to 150V.

sch_SCC0234-01_001.r00

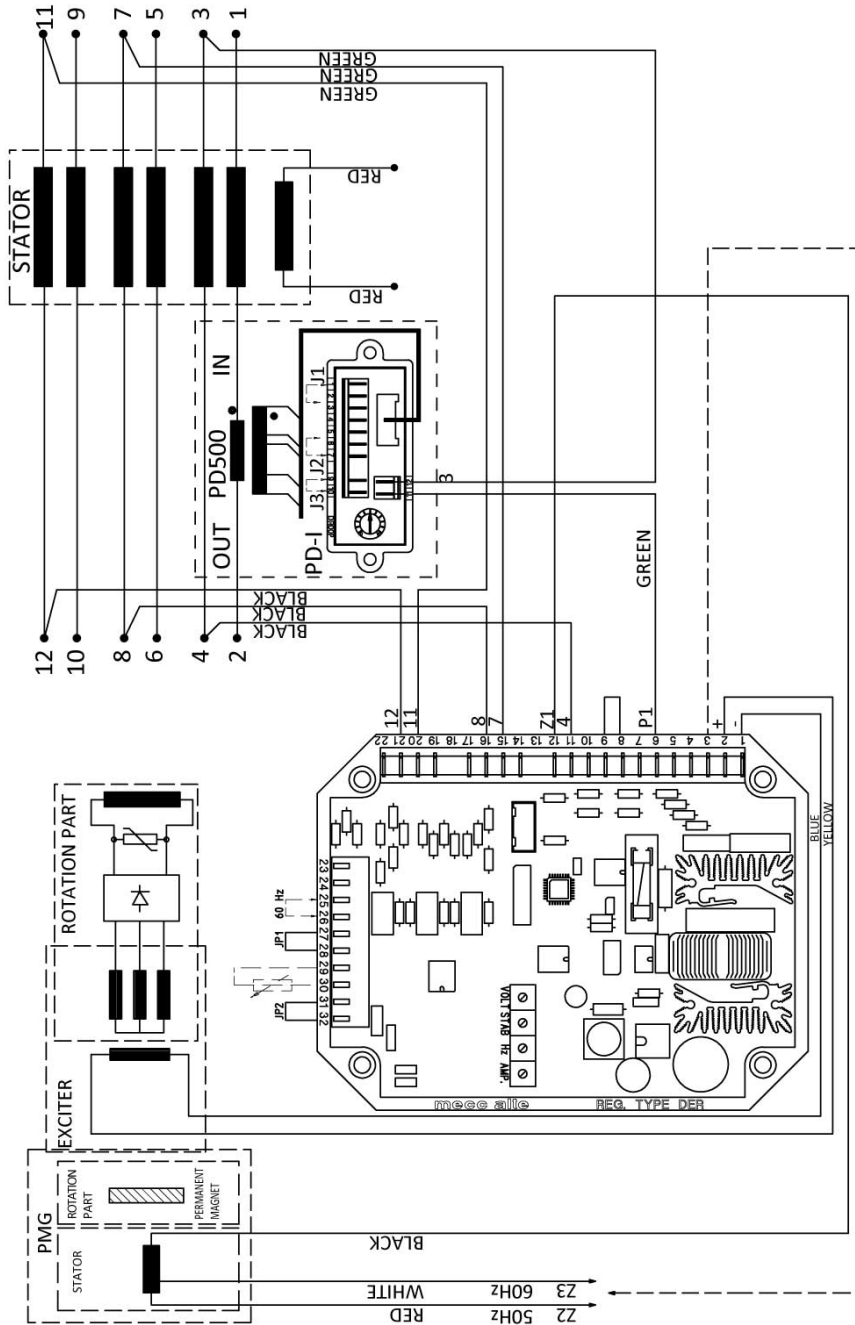

The electric scheme is valid also in case of use of the DER2 regulator instead of the DER1 regulator, represented in the scheme

SCC0235: Alternators with 12 terminals, with PMG, DER1 regulator, three-phase reference from 150V to 300V.

sch_SCC0235-01_001-r00

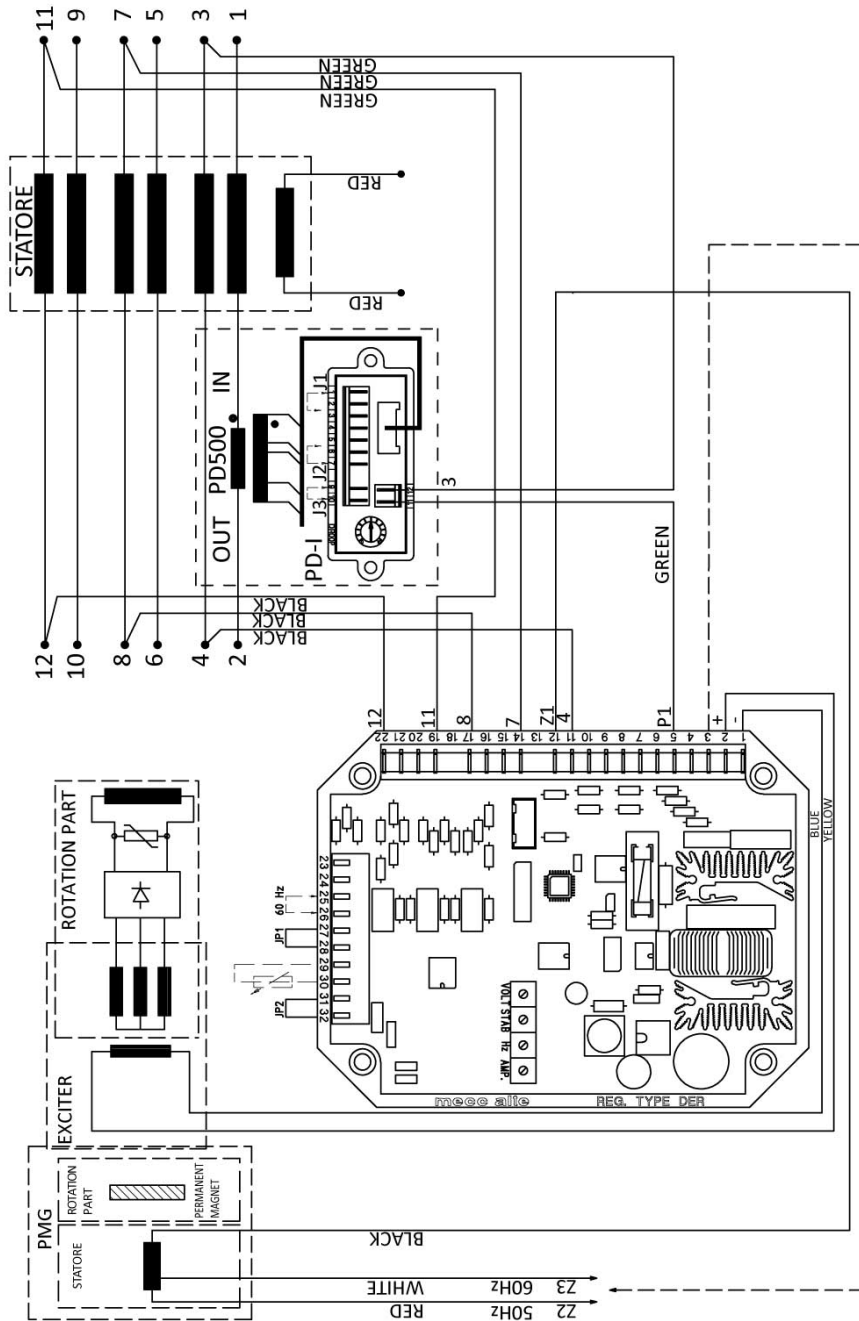

The electric scheme is valid also in case of use of the DER2 regulator instead of the DER1 regulator, represented in the scheme

12.4 Electrical diagrams with UVR6 - SR7 regulators

A2544: Alternators with 6 terminals, with SR7 analog regulator.

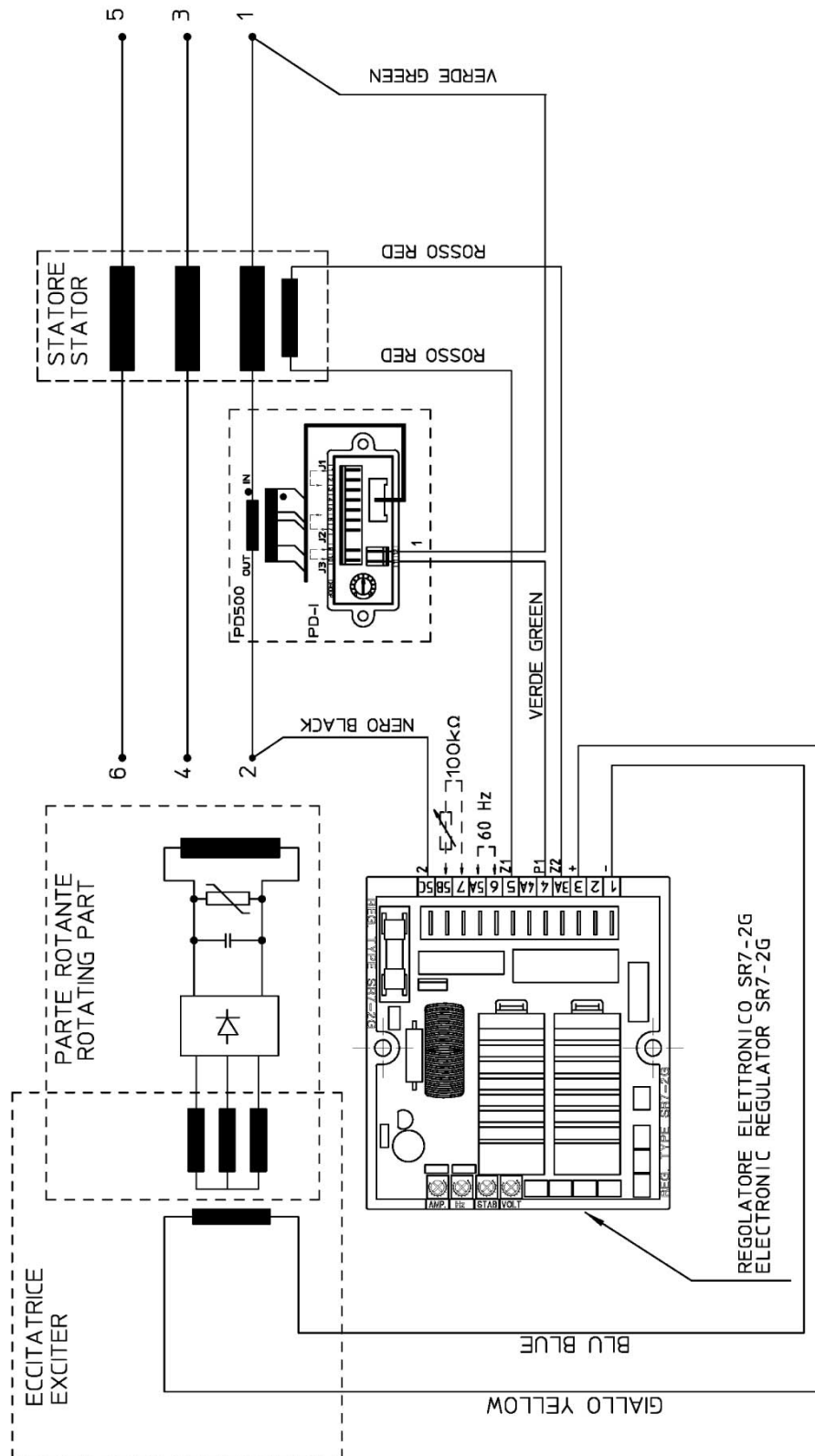

sch_A2544-04_001r00

A2550: Alternators with 6 terminals, with UVR6 analog regulator.

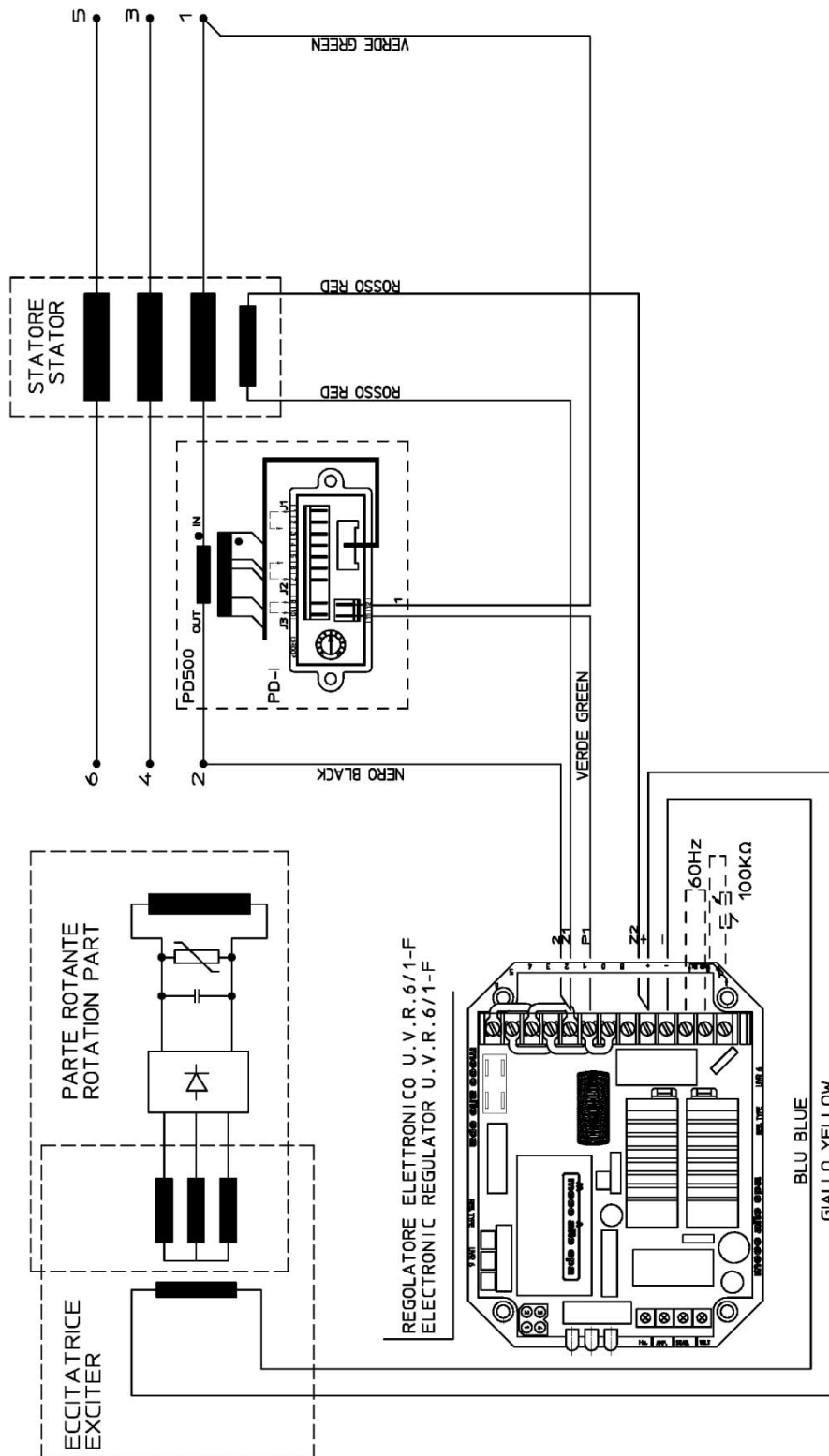

sep_A2550_04_001-r00

A2545: Alternators with 12 terminals, with SR7 analog regulator.

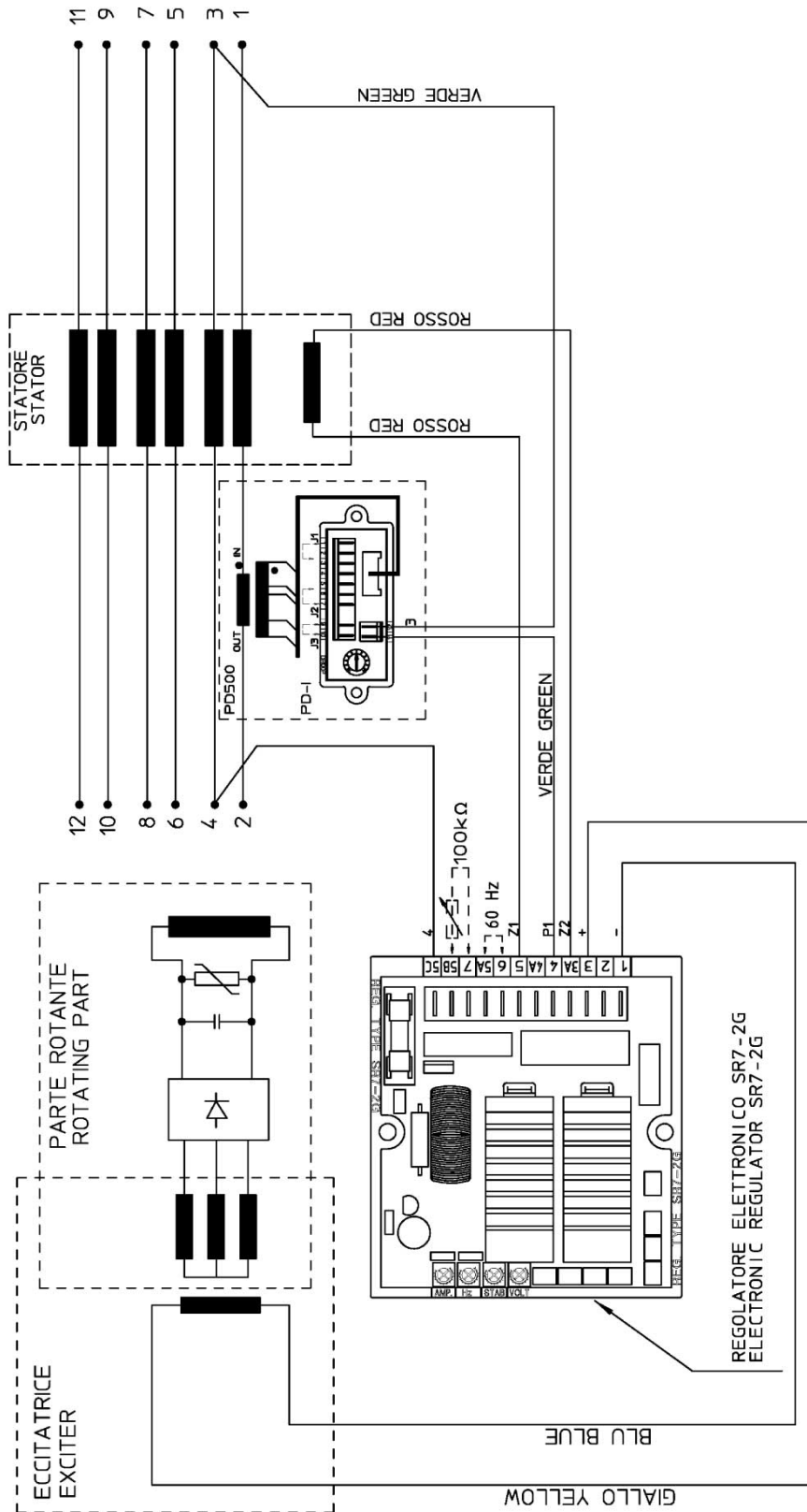

ser_A2545-04_001-00

A2549: Alternators with 12 terminals, with UVR6 analog regulator.

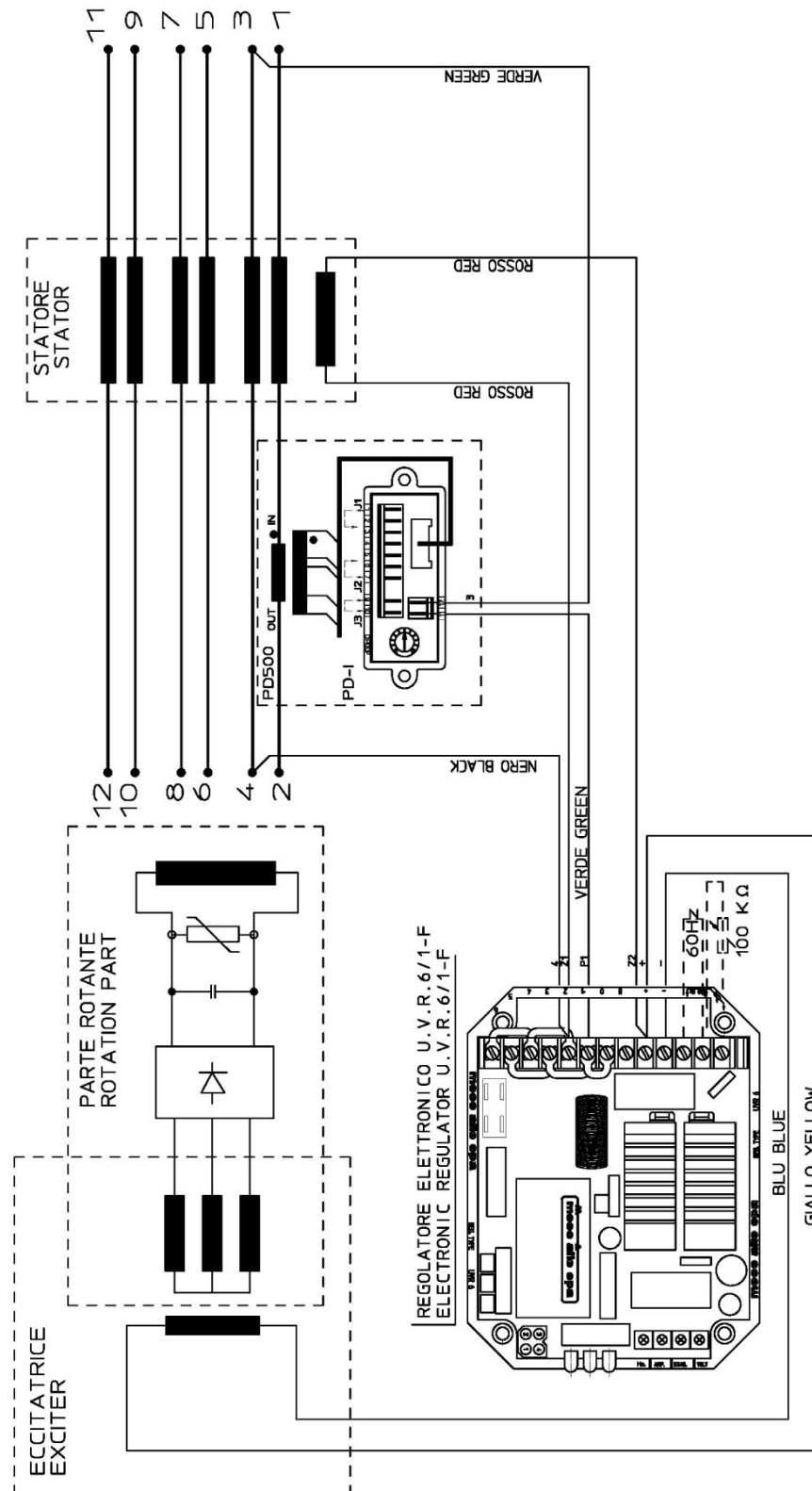

sef_A2549-04_001-00

A2548: Alternators with 6 terminals, three-phase reference with UVR6 analog regulator.

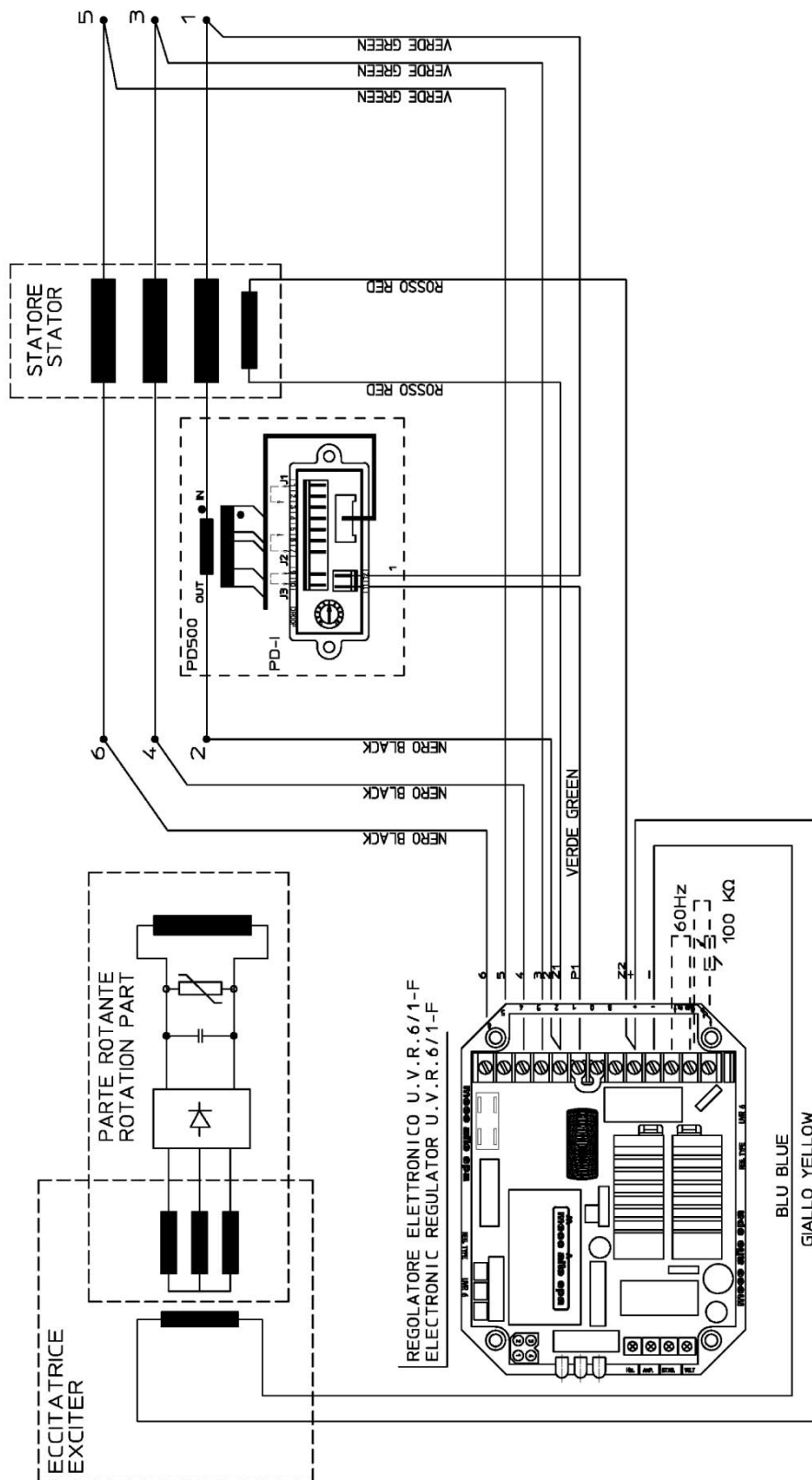

sef_A2548_05_001-00

A2552: Alternators with 12 terminals, three-phase reference with UVR6 analog regulator.

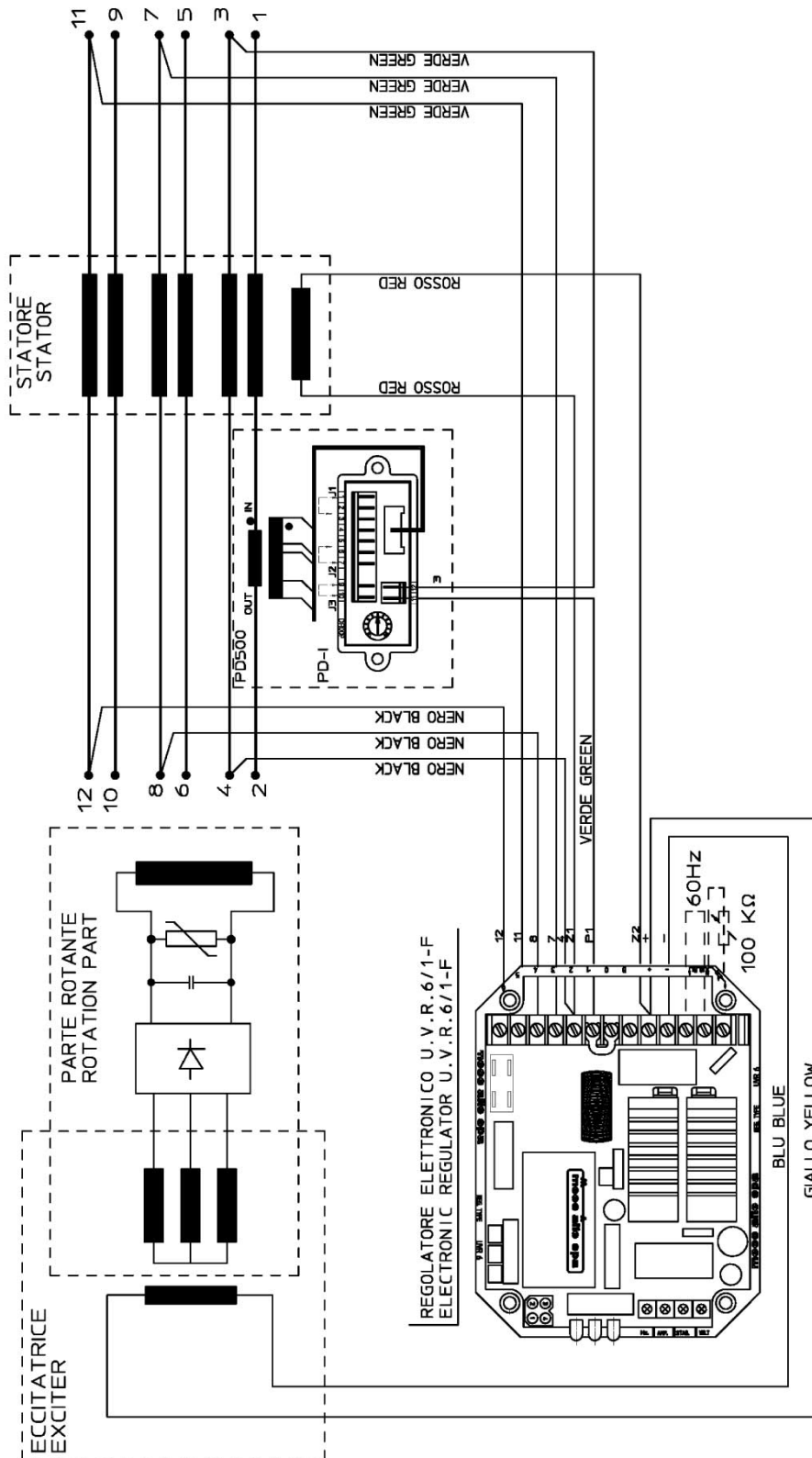

sep_A2552_04_001-r00

SCC0055: Alternators with 12 terminals (ZIG ZAG connection), with SR7 analog regulator.

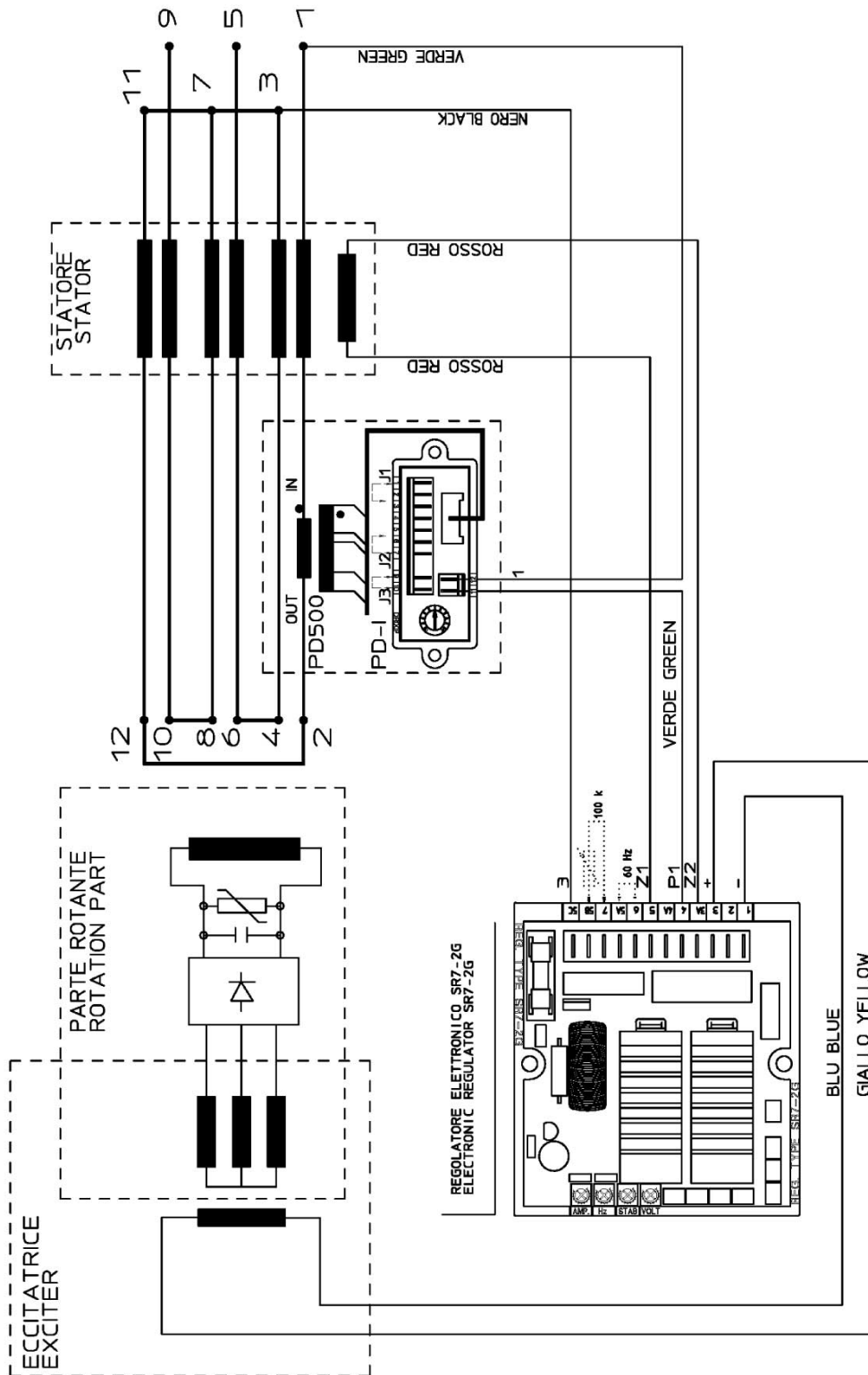

seh_SCC0055-01_001-00

SCC0054: Alternators with 12 terminals (ZIG ZAG connection), with UVR6 analog regulator.

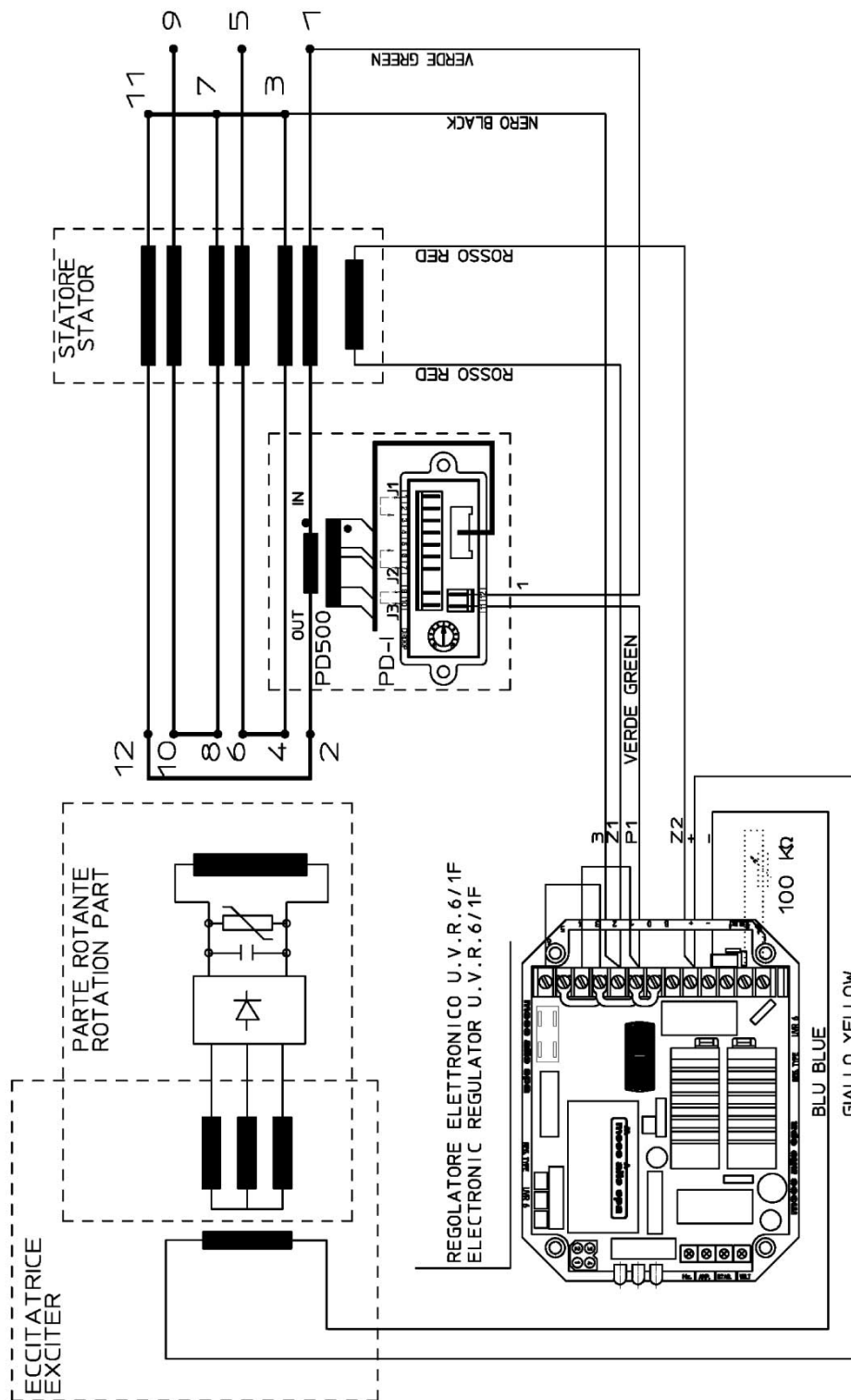

seh_SCC0054-01_001-r00

13 Replacement parts

13.1 ECO 38A Construction type MD35

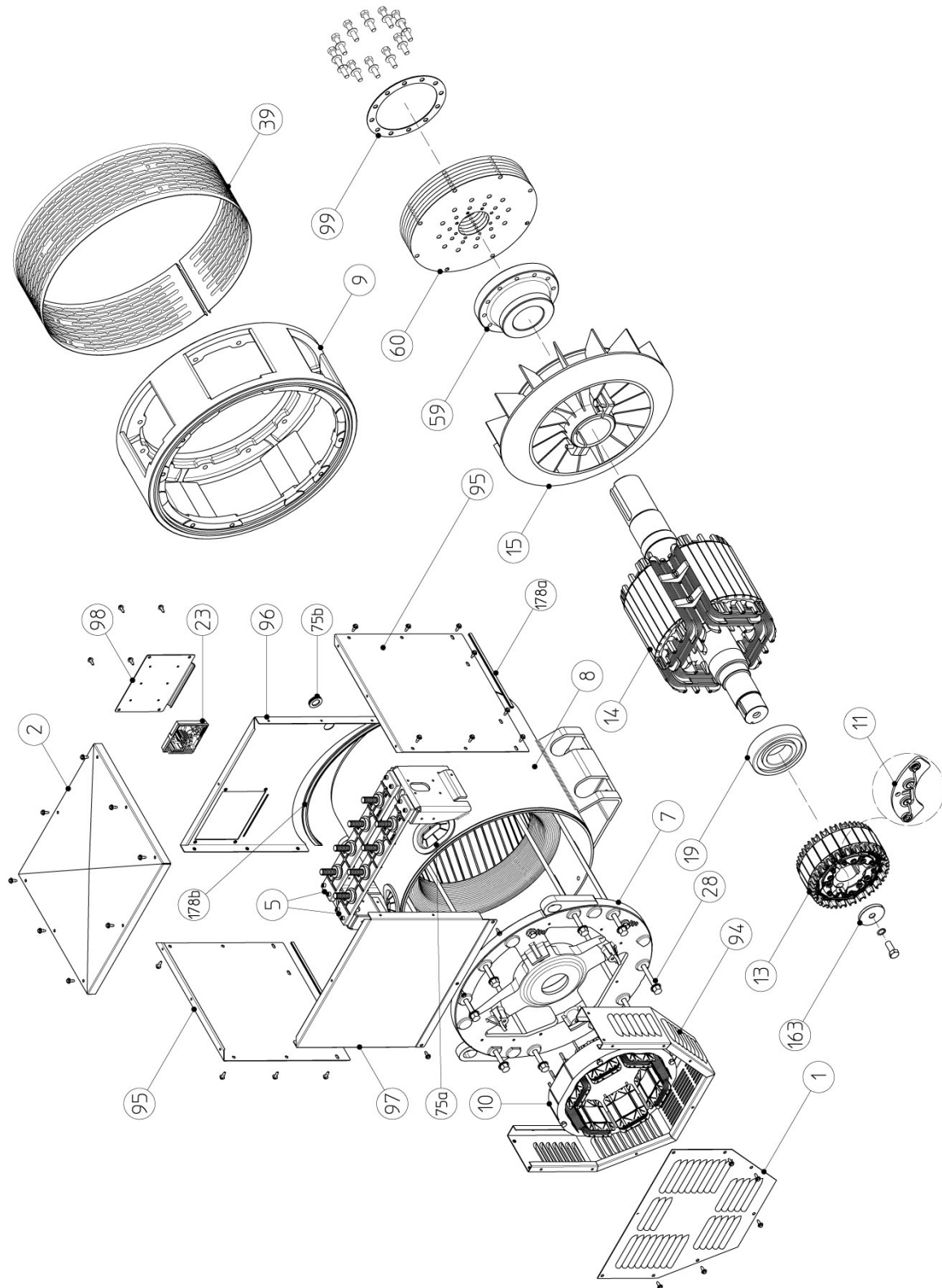

Tav_A9461-00_ECO38A_MD35_001-00

ECO 38 List of replacement parts

Item	Name	
1	Back latch	
2	Protective cover	
5	U1-V1-W1 use terminal block	
	U2-V2-W2 use terminal block	
7	Back cover	
8	Frame with stator	
9	Front Cover MD35	SAE 0.5
		SAE 1
		SAE 2
		SAE 3
10	Exciter stator	
11	Rotating diode bridge	
13	Exciter rotor	
14	Rotating Inductor	
15	Fan	
19	Back bearing	
23	DSR Electronic Regulator	

Item	Name
28a	Cover rod S
28b	Cover rod L
39	Single-bearing protective net
59	Flywheel disc holder hub 14-11 1/2
60	SAE 14 Discs
	SAE Discs 11 1/2
75a	Cable gland rubber washer
75b	Cable gland rubber washer DG 21
94	Back carter
95	Panel on terminal block side
96	Terminal block back panel
97	Terminal block back panel
98	Regulator holder panel
99	Disc blocking ring
163	Blocking washer
178a	EPDM rubber profile size 8.5x5.5mm
178b	UL EPDM+SP reinforced profile size 15.6x8.4mm

13.2 ECO 38A Construction type B3B14

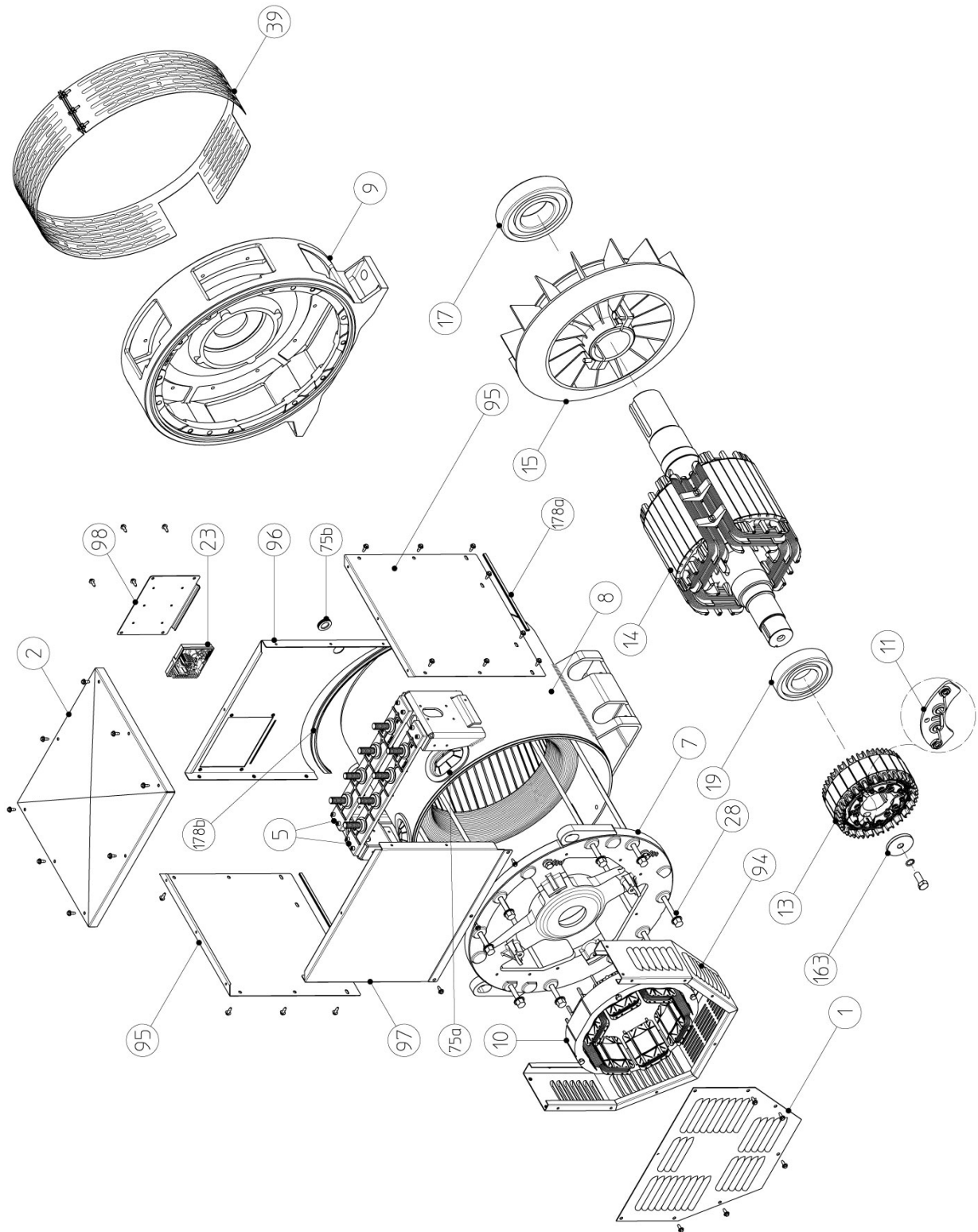

Tav_A9403-00_ECO38A_B3B14_001-00

ECO 38 List of replacement parts

Item	Name
1	Back latch
2	Protective cover
5	U1-V1-W1 use terminal block
	U2-V2-W2 use terminal block
7	Back cover
8	Frame with stator
9	Front Cover B3B14
10	Exciter stator
11	Rotating diode bridge
13	Exciter rotor
14	Rotating Inductor
15	Fan
17	Front bearing
19	Back bearing
23	DSR Electronic Regulator

Item	Name
28a	Cover rod S
28b	Cover rod L
39	Double-bearing protective net
75a	Cable gland rubber washer
75b	Cable gland rubber washer DG 21
94	Back carter
95	Panel on terminal block side
96	Terminal block back panel
97	Terminal block back panel
98	Regulator holder panel
99	Disc blocking ring
163	Blocking washer
178a	EPDM rubber profile size 8.5x5.5mm
178b	UL EPDM+SP reinforced profile size 15.6x8.4mm

13.3 ECO 40B Construction type MD35

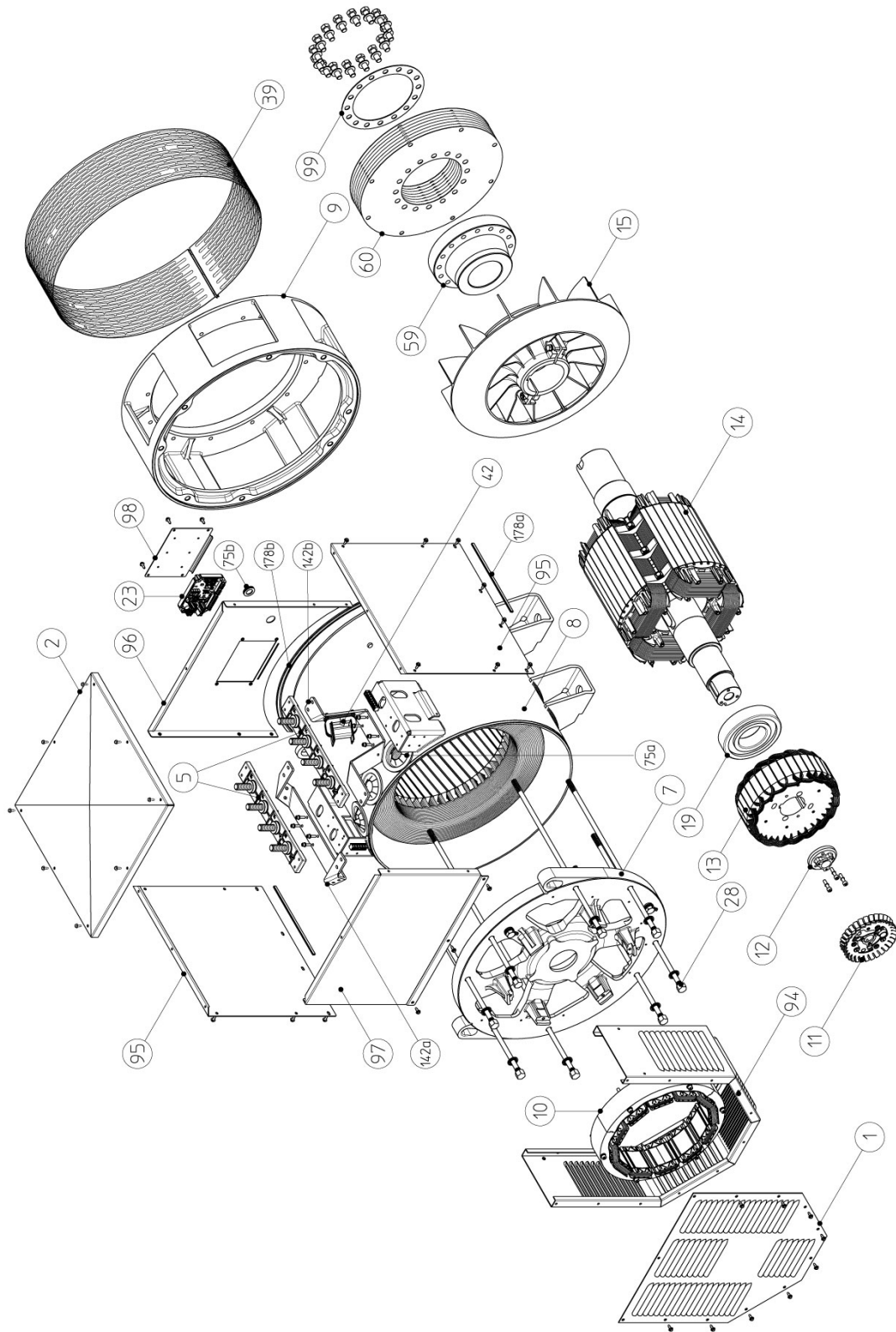

Tab. A 0396-00_ECO40A_MD35_001-00

ECO 40 List of replacement parts

Item	Name	
1	Back latch	
2	Protective cover	
5	U2-V2-W2 use terminal block	
	U2-V2-W2 use terminal block	
7	Back cover	
8	Frame with stator	
9	Front Cover MD35	SAE 1
		SAE 0.5
		SAE 0
		SAE 00
10	Exciter stator	
11	Rotating diode bridge	
12	Exciter blocking hub	
13	Exciter rotor	
14	Rotating Inductor	
15	Fan	
19	Back bearing	
23	DER1 Electronic Regulator	
28a	Cover rod S	

Item	Name
28b	Cover rod L
28c	Cover rod VL
39	Single-bearing protective net
42	Fastening of paralleling device
59	Flywheel disc holder hub 14-11 1/2
60	SAE 14 Discs
	SAE 18 Discs
75a	Cable gland rubber washer
75b	Cable gland rubber washer DG 21
94	Back carter
95	Panel on terminal block side
96	Terminal block back panel
97	Terminal block back panel
98	Regulator holder panel
99	Disc blocking ring
142a	Left support bracket
142b	Right support bracket
178a	EPDM rubber profile size 8.5x5.5mm
178b	UL EPDM+SP reinforced profile size 15.6x8.4mm

13.4 ECO 40B Construction type B3B14

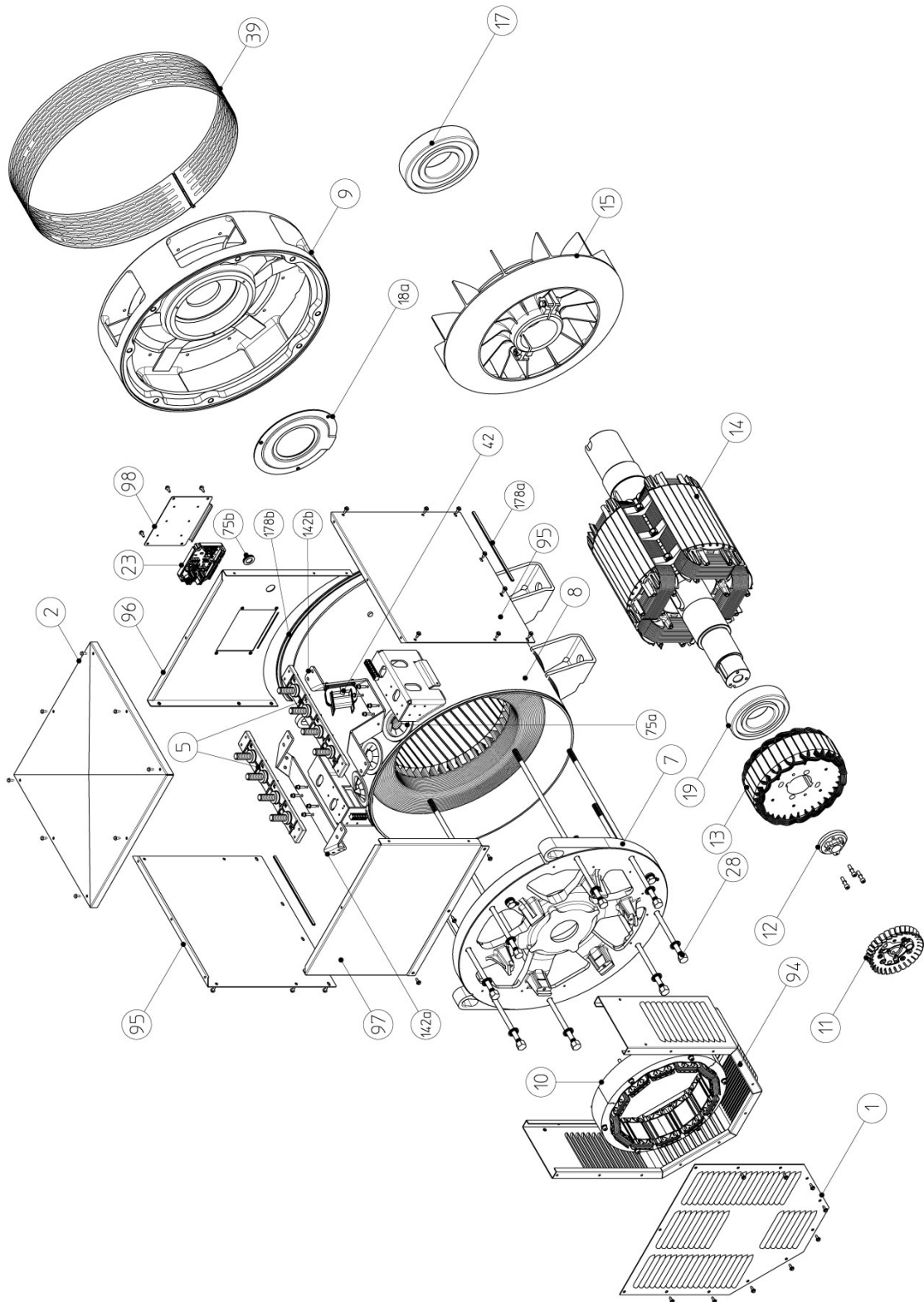

Tel_A604-00_ECO40A_B3B14_001-00

ECO 40 List of replacement parts

Item	Name
1	Back latch
2	Protective cover
5	U2-V2-W2 use terminal block
	U2-V2-W2 use terminal block
7	Back cover
8	Frame with stator
9	Front Cover B3B14
10	Exciter stator
11	Rotating diode bridge
12	Exciter blocking hub
13	Exciter rotor
14	Rotating Inductor
15	Fan
17	Front bearing
19	Back bearing
23	DER1 Electronic Regulator
28a	Cover rod S

Item	Name
28b	Cover rod L
28c	Cover rod VL
39	Double-bearing protective net
42	Fastening of paralleling device
75a	Cable gland rubber washer
75b	Cable gland rubber washer DG 21
94	Back carter
95	Panel on terminal block side
96	Terminal block back panel
97	Terminal block back panel
98	Regulator holder panel
99	Disc blocking ring
142a	Left support bracket
142b	Right support bracket
178a	EPDM rubber profile size 8.5x5.5mm
178b	UL EPDM+SP reinforced profile size 15.6x8.4mm

13.5 ECO 43A Construction type MD35

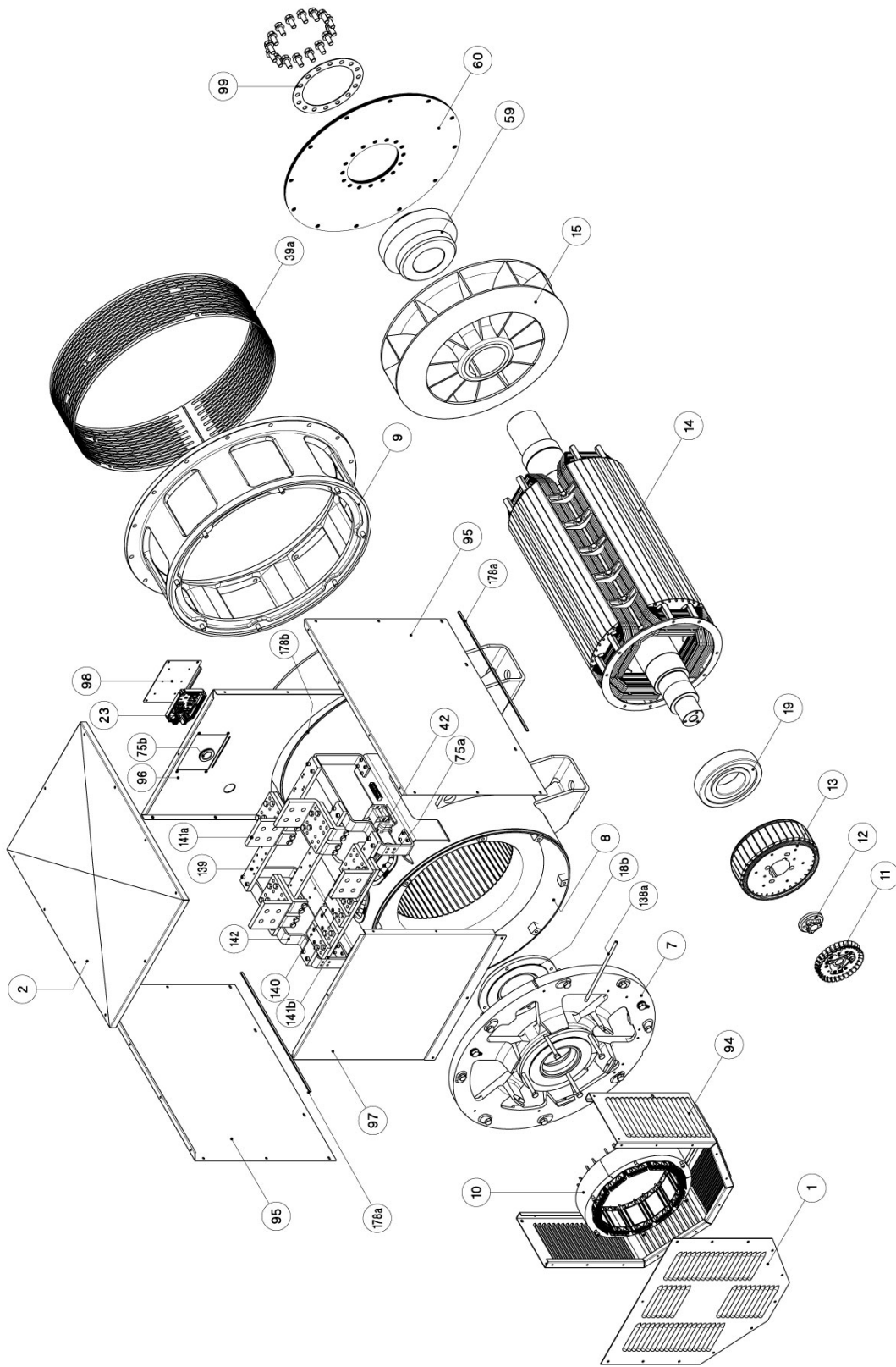

Tav_A5209-01_ECO43A_MD35_001-r00

ECO 43 List of replacement parts

Item	Name	
1	Back latch	
2	Protective cover	
7	Back cover	
8	Frame with stator	
9	Front Cover	MD35 SAE 0
		MD35 SAE 00
10	Exciter stator	
11	Rotating diode bridge	
12	Exciter blocking hub	
13	Exciter rotor	
14	Rotating Inductor	
15	Fan	
17	Front bearing	
18a	Internal front flange	
18b	Internal back flange	
19	Back bearing	
23	DER1/A Electronic Regulator	
39a	Single-bearing protective net	
42	Fastening of paralleling device	

Item	Name
59	Flywheel disc holder hub 21
	Flywheel disc holder hub 18
60	SAE 21 Discs
	SAE 18 Discs
75a	Cable gland rubber washer
75b	Cable gland rubber washer DG29
94	Back carter
95	Panel on terminal block side
96	Terminal block back panel
97	Terminal block back panel
98	Regulator holder panel
99	Disc blocking ring
138a	Back lubricator tube
139	Terminal board support bracket
140	Aluminum terminal
141a	Aluminum bridge
141b	Aluminum connection bar
142	Support bracket
178a	EPDM rubber profile size 8.5x5.5mm
178b	UL EPDM+SP reinforced profile size 15.6x8.4mm

ECO 43 List of replacement parts

Item	Name
1	Back latch
2	Protective cover
7	Back cover
8	Frame with stator
9a	Front Cover B3B14
10	Exciter stator
11	Rotating diode bridge
12	Exciter blocking hub
13	Exciter rotor
14	Rotating Inductor
15	Fan
17	Front bearing
18a	Internal front flange
18b	Internal back flange
19	Back bearing
23	DER1/A Electronic Regulator
39a	Single-bearing protective net
39b	Double-bearing protective net

Item	Name
42	Fastening of paralleling device
75a	Cable gland rubber washer
75b	Cable gland rubber washer DG29
94	Back carter
95	Panel on terminal block side
96	Terminal block back panel
97	Terminal block back panel
98	Regulator holder panel
138a	Back lubricator tube
138b	Front lubricator tube B3B14
139	Terminal board support bracket
140	Aluminum terminal
141a	Aluminum bridge
141b	Aluminum connection bar
142	Support bracket
178a	EPDM rubber profile size 8.5x5.5mm
178b	UL EPDM+SP reinforced profile size 15.6x8.4mm

13.7 ECO 46A Construction type MD35

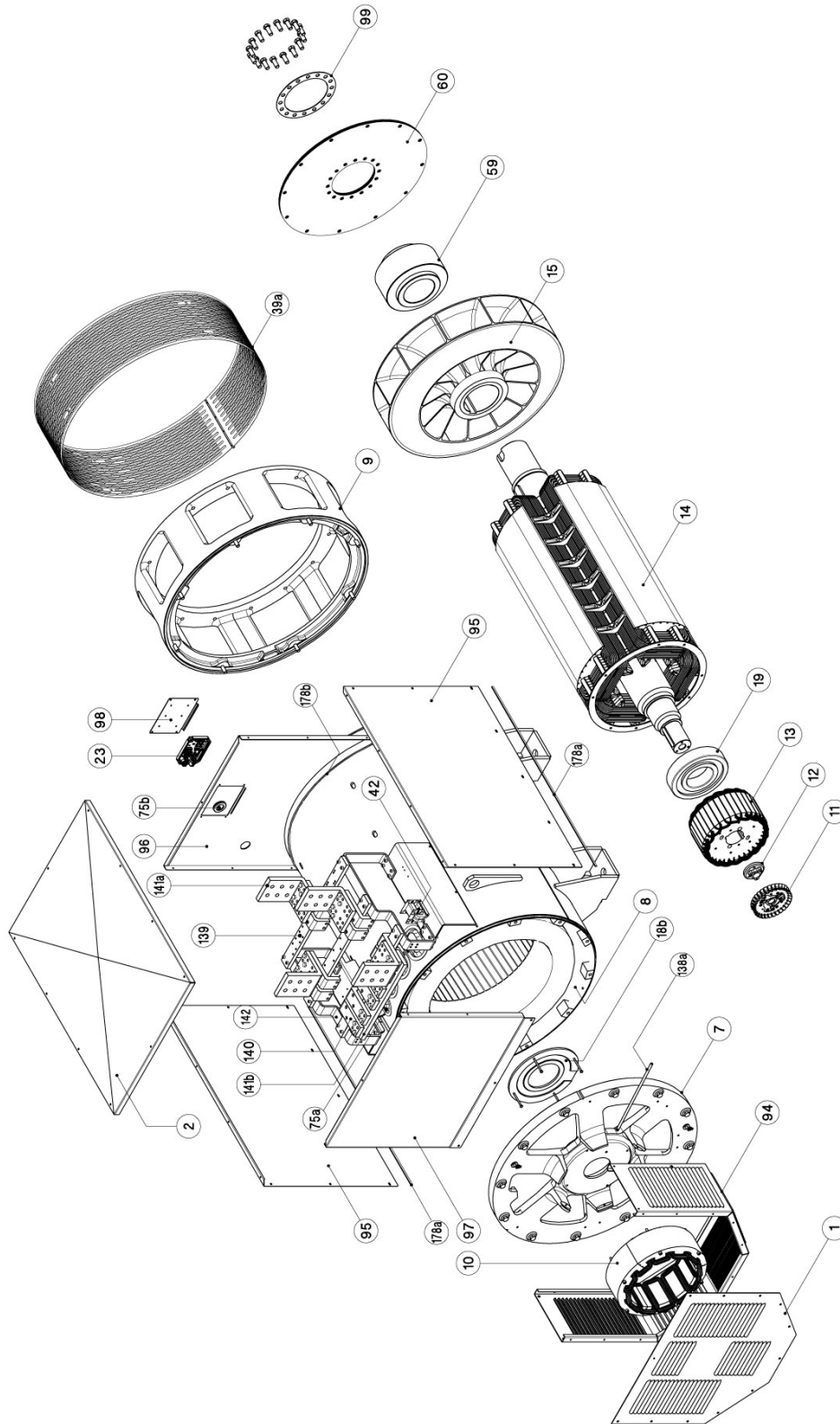

Ten_A8272-01_ECO46A_MD35_001-00

ECO 46 List of replacement parts

Item	Name	
1	Back latch	
2	Protective cover	
7	Back cover	
8	Frame with stator	
9	Front Cover	MD35 SAE 0
		MD35 SAE 00
10	Exciter stator	
11	Rotating diode bridge	
12	Exciter blocking hub	
13	Exciter rotor	
14	Rotating Inductor	
15	Fan	
17	Front bearing	
18a	Internal front flange	
18b	Internal back flange	
19	Back bearing	
23	DER1/A Electronic Regulator	
39a	Single-bearing protective net	
39b	Double-bearing protective net	
42	Fastening of paralleling device	

Item	Name
59	Flywheel disc holder hub 21
	Flywheel disc holder hub 18
60	SAE 21 Discs
	SAE 18 Discs
75a	Cable gland rubber washer
75b	Cable gland rubber washer DG29
94	Back carter
95	Panel on terminal block side
96	Terminal block back panel
97	Terminal block back panel
98	Regulator holder panel
99	Disc blocking ring
138a	Back lubricator tube
139	Terminal board support bracket
140	Aluminum terminal
141a	Aluminum bridge
141b	Aluminum connection bar
142	Support bracket
178a	EPDM rubber profile size 8.5x5.5mm
178b	UL EPDM+SP reinforced profile size 15.6x8.4mm

ECO 46 List of replacement parts

Item	Name
1	Back latch
2	Protective cover
7	Back cover
8	Frame with stator
9a	Front Cover B3B14
10	Exciter stator
11	Rotating diode bridge
12	Exciter blocking hub
13	Exciter rotor
14	Rotating Inductor
15	Fan
17	Front bearing
18a	Internal front flange
18b	Internal back flange
19	Back bearing
23	DER1/A Electronic Regulator
39b	Double-bearing protective net

Item	Name
42	Fastening of paralleling device
75a	Cable gland rubber washer
75b	Cable gland rubber washer DG29
94	Back carter
95	Panel on terminal block side
96	Terminal block back panel
97	Terminal block back panel
98	Regulator holder panel
138a	Back lubricator tube
138b	Front lubricator tube B3B14
139	Terminal board support bracket
140	Aluminum terminal
141a	Aluminum bridge
141b	Aluminum connection bar
142	Support bracket
178a	EPDM rubber profile size 8.5x5.5mm
178b	UL EPDM+SP reinforced profile size 15.6x8.4mm

14 Dismantlement and disposal

To dispose of the alternator or its components you will have to recycle it, keeping in mind the nature of its various components (for instance: metals, plastic parts, rubber, oil and so on).

You will have to designate specialized companies for this purpose and , however, observe the waste management applicable laws.



Most of the materials used in the alternators can be recycled by specialized waste management companies. The instructions contained in this chapter are recommendations to follow for environmentally sound disposal; the user has the responsibility of observing local regulations.



For indicative percentages of the materials used in Mecc Alte alternators see paragraph 2.3.9.

Mecc Alte SpA (HQ)

Via Roma
20 – 36051 Creazzo
Vicenza – ITALY
T: +39 0444 396111
F: +39 0444 396166
E: info@meccalte.it
aftersales@meccalte.it

Mecc Alte Portable

Via A. Volta
1 – 37038 Soave
Verona – ITALY
T: +39 045 6173411
F: +39 045 6101880
E: info@meccalte.it
aftersales@meccalte.it

Mecc Alte Power Products srl

Via Melaro
2 – 36075 Montecchio
Maggiore (VI) – ITALY
T: +39 0444 1831295
F: +39 0444 1831306
E: info@meccalte.it
aftersales@meccalte.it

Zanardi Alternators

Via Dei Laghi
48/B – 36077 Altavilla
Vicenza – ITALY
T: +39 0444 370799
F: +39 0444 370330
E: info@zanardialternatori.it

United Kingdom

Mecc Alte U.K. LTD
6 Lands' End Way
Oakham
Rutland LE15 6RF
T: +44 (0) 1572 771160
F: +44 (0) 1572 771161
E: info@meccalte.co.uk
aftersales@meccalte.co.uk

Spain

Mecc Alte España S.A.
C/ Rio Taibilla, 2
Polig. Ind. Los Valeros
03178 Benijofar (Alicante)
T: +34 (0) 96 6702152
F: +34 (0) 96 6700103
E: info@meccalte.es
aftersales@meccalte.es

China

Mecc Alte Alternator Haimen LTD
755 Nanhai East Rd
Jiangsu HEDZ 226100 PRC
T: +86 (0) 513 82325758
F: +86 (0) 513 82325768
E: info@meccalte.cn
aftersales@meccalte.cn

India

Mecc Alte India PVT LTD
Plot NO: 1, Sanaswadi
Talegaon
Dhamdhare Road Taluka:
Shirur, District:
Pune - 412208
Maharashtra, India
T: +91 2137 619600
F: +91 2137 619699
E: info@meccalte.in
aftersales@meccalte.in

U.S.A. and Canada

Mecc Alte Inc.
1229 Adams Drive
McHenry, IL, 60051
T: +1 815 344 0530
F: +1 815 344 0535
E: info@meccalte.us
aftersales@meccalte.us

Germany

Mecc Alte Generatoren GmbH
Ensener Weg 21
D-51149 Köln
T: +49 (0) 2203 503810
F: +49 (0) 2203 503796
E: info@meccalte.de
aftersales@meccalte.de

Australia

Mecc Alte Alternators PTY LTD
10 Duncan Road, PO Box 1046
Dry Creek, 5094, South
Australia
T: +61 (0) 8 8349 8422
F: +61 (0) 8 8349 8455
E: info@meccalte.com.au
aftersales@meccalte.com.au

France

Mecc Alte International S.A.
Z.E. La Gagnerie
16330 ST. Amant de Boixe
T: +33 (0) 545 397562
F: +33 (0) 545 398820
E: info@meccalte.fr
aftersales@meccalte.fr

Far East

Mecc Alte (F.E.) PTE LTD
19 Kian Teck Drive
Singapore 628836
T: +65 62 657122
F: +65 62 653991
E: info@meccalte.com.sg
aftersales@meccalte.com.sg



www.meccalte.com