

UPS IST7

50 - 200 kVA

User Manual



Foreword

Summaries

Thank you for choosing the UPS product!

This document gives a description of the IST7 series (10kVA-200kVA) UPS.

Please save the manual after reading, in order to consult in the future.



NOTE

The figures in this manual are just for reference, for details please see the actual product.

Symbol Conventions

The manual quotes the safety symbols, these symbols used to prompt users to comply with safety matters during installation, operation and maintenance. Safety symbol meaning as follows.

Symbol	Description
DANGER	Alerts you to a high risk hazard that could, if not avoided, result in serious injury or death.
WARNING	Alerts you to a medium or low risk hazard that could, if not avoided, result in moderate or minor injury.
CAUTION	Alerts you to a potentially hazardous situation that could, if not avoided, result in equipment damage, data loss, performance deterioration, or unanticipated results.
	Anti-static prompting.
	Be care electric shock prompting.
TIP	Provides a tip that may help you solve a problem or save time.
NOTE	Provides additional information to emphasize or supplement important points in the main text.

Contents

- 1 Safety Instructions 1**
 - 1.1 Safety Announcements 1
 - 1.1.1 Safety Instructions 1
 - 1.1.2 Use Announcements for Battery 4
 - 1.1.3 Anti-Static Protection 4
 - 1.1.4 Grounding Requirements 5
 - 1.1.5 Safety Warning Label Setting 5
 - 1.1.6 Measure with Electricity 5
 - 1.2 Operation and Maintenance Requirements 6
 - 1.3 Environment Requirements 7
- 2 Overview 8**
 - 2.1 Product Introduction 8
 - 2.1.1 Product Features 8
 - 2.2 Work Principle 9
 - 2.2.1 Work Principle Diagram 9
 - 2.2.2 Work Mode 9
 - 2.3 Appearance and Structure 11
 - 2.3.1 Appearance 11
 - 2.3.2 Structure Layout (Open Door) 14
 - 2.3.3 Alarm Function 18
- 3 Installation 22**
 - 3.1 Installation Procedure 22
 - 3.2 Installation Preparation 23
 - 3.2.1 Installation Tools 23

3.2.2 Installation Environment.....	24
3.2.3 Installation Space	25
3.2.4 Selection for Input and Output Wires.....	26
3.2.5 Surge ProtectionDevice.....	29
3.2.6 Reverse Feedback Protection (Optional).....	29
3.3 Transportation and Unpacking	29
3.3.1 Transportation	29
3.3.2 Unpacking	30
3.4 Mechanical Installation	34
3.4.1 UPS Installation	34
3.4.2 Wiring	38
3.4.3 Install Battery Cabinet	45
3.5 System Check and Test.....	46
3.5.1 Check Electrical Connection.....	46
3.5.2 UPS Test.....	47
3.5.3 Connect Load	47
4 Touch Screen Operation and Setting	48
4.1 Menu Hierarchy	48
4.2 MainPage	49
4.3 System Work Status Display	50
4.4 Monitor Function	54
4.4.1 Bypas Input Information	54
4.4.2 Mains Information	55
4.4.3 Battery Information.....	55
4.4.4 System Output Information Page	57
4.5 Information Query.....	57
4.5.1 Event Log.....	58
4.5.2 User Log	58
4.5.3 Device Information	58
4.6 Setting Management.....	60

4.6.1 System Management	61
4.6.2 Battery Management	64
4.6.3 Battery Test	67
4.6.4 Function Configuration	67
4.6.5 HMI Setting	68
4.6.6 Password Setting	69
4.7 Buzzer Control	70
4.8 ON/OFF	70
5 Use and Operation	71
5.1 Use Announcements	71
5.2 Operation Procedure	71
5.3 UPS Start and Shutdown	72
5.3.1 Check before Startup	72
5.3.2 Startup	72
5.3.3 UPS Shutdown	74
5.3.4 Switch to Bypass Mode Manually	74
5.3.5 Switch to Maintenance Bypass Mode From Inverter Output	75
5.3.6 Switch to Inverter Output from Maintenance Bypass	76
5.3.7 Emergency Power Off (EPO)	76
5.3.8 Emergency Power Off Recovery	77
5.4 Parallel System Startup and Shutdown	77
5.4.1 Start Parallel System	77
5.4.2 Shutdown Parallel System	79
5.4.3 Emergency Power Off (EPO)	80
6 Maintenance and Troubleshooting	81
6.1 Maintenance Guide	81
6.1.1 Safety Precautions	81
6.1.2 Preventive Maintenance	81
6.2 Battery Maintenance	81
6.3 Announcements for Battery Replacement	82

6.4 Troubleshooting.....	83
6.4.1 Common Abnormal Phenomena Diagnosis	83
6.4.2 Emergency Dispose for System Fault	85
7 Package, Transportation and Storage.....	87
7.1 Package	87
7.2 Transportation	87
7.3 Storage	87
A Technical Specifications	88

1 Safety Instructions

1.1 Safety Announcements

This section introduces the safety announcements that must be complied with and pay special attention while installing, using, maintenance and other relative operations.



CAUTION

Before operating, please read the announcements and operation instructions in this section carefully, which is to avoid accident.

The DANGER, WARNING, CAUTION in the manual are not all the safety announcements that you must abide by, they are just the supplements for the safety announcements during operating.



NOTE

Our Company does not undertake the responsibility caused by violating common safety operation requirements or the safety standard of design, manufacture and use.

1.1.1 Safety Instructions



CAUTION

The input and output of the UPS is dangerous high voltage, once operate improperly, it may endanger human safety. Please read this manual carefully before installing or operating, and pay attention to the warning labels. Do not dismantle the case of the UPS unless authorized person.

**DANGER**

It is prohibited to touching any terminal or conductor that connected with grid circuit, or, it may cause deadly danger.

**DANGER**

The damaged device or device fault may cause electric shock or firing!

- Before operating, please inspect the device and see if there is any damage or exist other danger.
 - Check if the external devices or circuit connection is safe.
-

**DANGER**

During a lightning storm, it is strictly prohibited to perform high voltage and AC operation, as well as in the tower or the mast. The atmosphere will generate a strong electromagnetic field in a lightning storm. Therefore, in order to avoid equipment struck by lightning, lightning protection and grounding system should be prepared in time.

**WARNING**

If the output load is impact feedback device, please consult the engineer of our company.

**WARNING**

Do not reversely connect the ground wire and neutral wire, live wire and neutral wire, which will cause short circuit.

It should be well grounded and the voltage between ground wire and neutral wire should be less than 5V.



WARNING

Please do not put finger or tool into rotating fans to avoid endanger the human safety or damage the device.



WARNING

In case of fire, please use dry power fire extinguisher. If using liquid fire extinguisher, it may cause electric shock.



CAUTION

No liquid or other objects are allowed to enter the cabinet.



CAUTION

The product is class C3 device. If the product is used in resident living, it may cause wireless interference. User should take actions to avoid the interference.



CAUTION

Warning label should be affixed away from UPS location!

When UPS is power off, there still exists dangerous voltage. It should affix warning labels away from UPS location and the warning labels should include: 1. It supplies power for UPS. 2. Please disconnect UPS before wiring.

1.1.2 Use Announcements for Battery



CAUTION

Please use specified battery. Non-specified battery will damage the UPS.

The charging voltage of different brand and different model battery is different. Before using, ensure that the charging voltage of the UPS matches that of battery. If doubted, please consult the manufacturer for support.



WARNING

Battery operation must be done according to instructions!

Battery operation must be done according to instructions, especially battery wiring. Irregular operation will cause battery damage, even human injury.

- It is prohibited to short circuit the anode and cathode of the battery. The battery wiring must be tightened. It is strictly prohibited to touch any two wiring terminals of battery or the bare terminals of wires simultaneously, or it may cause battery damage or human injury.
- Prevent electrolyte leaking from batteries. The metal objects and circuit board will be corroded by the overflowing electrolyte and it will result in equipment damage and circuit board short circuit.
- Keep the battery away from fire source and all device that easy cause spark to avoid danger or unnecessary lose.

1.1.3 Anti-Static Protection



CAUTION

The static generated by human bodies may damage the electrostatic-sensitive components on PCB. Before touching the sensitive component, please wear anti-static rings and well connect the other end of the anti-static rings to ground.

1.1.4 Grounding Requirements



WARNING

High leakage risk! The device must be grounded before electrical connection. The grounding terminal must be connected to earth.

- When installing, connect the grounding wire first; when dismantling, the grounding wire must be removed at last.
- It is prohibited to damage the grounding conductor.
- The device must be connected with protection earthing permanently. Before operating, please check the electric connection and ensure the device has been connected to earth reliably.

1.1.5 Safety Warning Label Setting

To avoid irrelevant person close to or misoperate the UPS, during installation or daily maintenance, please comply with the related standards.

- Set warning labels at the switches of input end and output end to avoid wrongly close and even cause accident.
- Set warning label or safety warning area to avoid irrelevant person entering and cause human injury or device damage.
- After maintenance, ensure that pull out the key of the UPS and save it properly.

1.1.6 Measure with Electricity



CAUTION

There is dangerous high voltage, contacting by accident may lead to deadly danger. So, when measure with electricity, it is necessary to do the protection (such as wear insulated gloves, etc.)

The measure meter must accord with the following requirements.

- The range and use condition of the measure meter should conform to the site requirements.
-

- Ensure that connection of the measure meter is proper and normative, which is to avoid the danger of electric arc, etc.

1.2 Operation and Maintenance Requirements

There exists high temperature and high voltage inside the UPS. Please comply with the relevant safety regulations and operation procedures during installation, operation and maintenance to avoid human injury or device damage. The safety precautions mentioned in the user manual is just as a supplement to the local safety regulations. Our company does not undertake the responsibility caused by violating the common safety operation requirements or safety standards for design, manufacture and use the device.



CAUTION

The related operation and wiring for the UPS should be performed by qualified professionals, and ensure the electric installation accord with the electricity installation standards.

The installation and maintenance man should be trained and know each safety announcements and get the right operation method, and then, the installation, operation and maintenance can be done.



DANGER

Mounting and dismantling power cables is prohibited when power on. Please switch off the power switches before mounting or dismantling power cables. Before connecting, make sure the cable connection, cable labels are in accordance with the actual installation.



WARNING

Touching high voltage directly or through damp objects will lead to lethal risk.

- Only authorized professionals are allowed to open the UPS chassis! The input and output of UPS are dangerous high voltage. Touching high voltage will lead to lethal risk.

- Before maintenance, please disconnect the AC power and battery to isolate the power input. It is better to measure the input, output and battery terminal bars by a voltmeter to ensure the input power is disconnected and in a safe condition.
- Even if all external power are disconnected, there still exists residual electric charge on the capacitance inside the UPS, and the output terminal bars may exists high voltage which endangers human life. It is necessary to set the UPS aside for enough time (≥ 10 min) to release all charge before opening the UPS chassis.
- The battery cables are not isolated with AC input. There may exist dangerous voltage between battery terminal and grounding terminal. Pay attention to the insulation when installing and using the battery.
- Do not wear conductive objects, such as watches, bracelets and rings during operating.
- The installing man should have the qualification of high voltage and AC power operation. The maintenance and repair for the power system only can be done by professional persons.
- Leakage risk! Before performing electrical connection, the UPS should be grounded. The ground terminal must be connected to the ground.

**WARNING**

Drilling holes on the cabinet is prohibited! Inappropriate drilling will damage the components inside the UPS. Metal debris generated by drilling will lead to circuit board short circuit.

1.3 Environment Requirements

The used environment may influence the service life and reliability of the device. So, please avoid using the device in the following environment for long time.

- The place where beyond the specification (normal work temperature: $-5^{\circ}\text{C}\sim 40^{\circ}\text{C}$, relative humidity: 0%-95%).
- The place where has direct sunshine and rain.
- The place where has vibration or easy impacted.
- The place where has dust, corrosive material, salty or flammable gas.
- The place where without good ventilation or closed.

2 Overview

2.1 Product Introduction

IST7 series product is the high-frequency online double-conversion UPS. It is the high performance sine-wave UPS that special designed for the network computer room, precision instrument, etc. of financial, communication, insurance, transportation, tax, army, security, energy, education, government, enterprise, etc.

2.1.1 Product Features

Three-level inversion technology

Adopts three-level inversion technology, which makes the quality of output voltage wave better and the efficiency of whole UPS higher.

Completely digitalized DSP control

Adopts digitalized DSP to control the inverting, phase synchronization, output current-sharing, logic of the power unit, which is with high precision, high speed and perfect whole system performance.

Energy conservation and high efficiency

Adopts advanced PFC control technology, the input power factor is greater than 0.99, which greatly improves the use ratio of electric energy and reduces the load of power grid, and save the cost of power distribution. The size of whole UPS is small, and the weight is light, calorific value is small, which enhances the use ratio of environment and decrease the investment cost.

Smart fan speed control

The fan speed is adjusted automatically in accordance with the load status, which prolong fan life and reduce noise.

ECO energy conservation mode design

The UPS is designed with ECO energy conservation mode. When the user power grid is good, if the UPS operating in this mode, the bypass prior to output, and the efficiency can be 99%.When the bypass voltage or frequency out of normal range and cannot satisfy the user's

power supply requirement, it will switch to inverter output, and this guarantee the reliability of power supply and also, save energy.

Manual maintenance bypass design

It designs manual maintenance bypass channel to ensure the UPS supply power for load while maintenance, which greatly improve the system operation reliability and maintainability.

Reliable EMC performance

Pass the authority institution and professional test on EMC, including conducting disturbance, radioactive disturbance, conducting anti- disturbance, radioactive anti- disturbance, power falling, mass impulse, static discharging, surge, etc. The excellent EMC characteristics can completely filter each power grid interference, and also, decrease and eliminate the interference of UPS itself effectively.

Touch screen display

With touch screen display, the operation is simple and convenient, which is convenient to daily manage and maintain the UPS. It can display the running parameters and running status of UPS and each power unit, and record the history event and alarm information. It can store 9000 pieces of information at most.

2.2 Work Principle

2.2.1 Work Principle Diagram

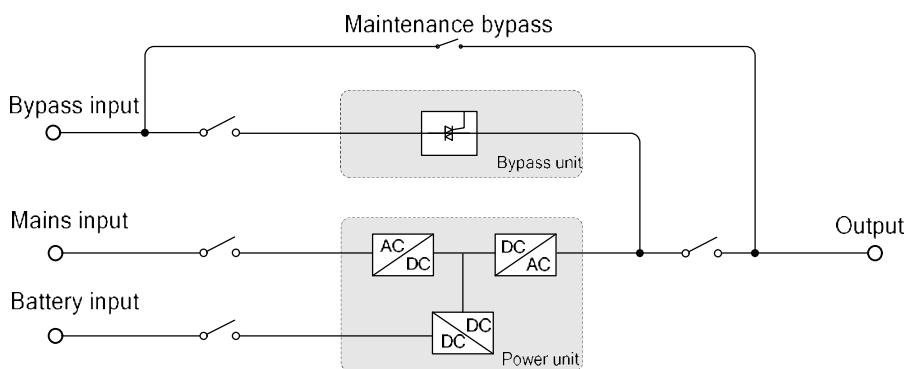

Figure2-1 Work principle diagram

2.2.2 Work Mode

There are 4 work modes of the UPS: normal mains mode, battery mode, bypass mode and maintenance bypass mode.

Normal mains mode

When the mains normal, AC power is transformed to DC power by PFC, and supply power for inverter. While rectifying the AC power into DC power, the rectifier eliminates the abnormal noise wave, noise and unstable frequency, and make the inverter provide stable and clean power for load. The specific work process is as follows.

When mains normal, the rectifier, inside the power unit, rectify the mains into anode and cathode DC voltage, and store energy in DC electrolysis for inverter to use. The inverter absorbs energy from DC electrolysis and inverts to output stable 220Vac voltage. When the system control card detects the inverter normal, it will supply the inverting voltage to load.

Battery mode

When mains abnormal, system will switch to battery input, the Boost circuit promotes the battery voltage to a certain value and then supply the DC power to the inverter, that makes the AC output without interruption phenomenon and then protect the load. The specific work process is as follows.

When mains abnormal at any time, the rectifier will switch to battery input immediately to maintain the voltage of DC electrolysis, which guarantee the inverter without power down. Before battery discharge completely, if mains recovers, the rectifier will switch to mains input and charge battery at the same time. During the switch between grid power supply and battery power supply, the inverter output cannot power down.

In battery power supply mode, if mains does not recover normal all the time, and the battery energy is running out, the UPS will send sound & light alarm, and stop working at the max. discharge point, and long beeps to alarm. At that time, the load will power down.

Bypass mode

When system abnormal (such as over-temperature, short-circuit, output voltage abnormal or overload) and exceed the bear range, the inverter will shut down to avoid damage automatically. If mains still normal at this time, it will turn to bypass to supply power for load. The specific work process is as follows.

If the inverter circuit fault or inverter overload and exceed the bear range, the UPS will turn to bypass to output. During bypass power supply, if fault or overload removed, the UPS will start inverter and begin to supply power for load. When the load is serious overload and exceeds the bypass bear range, the UPS will close the bypass output, and it will cause user load power down. When load fault or short circuit, the UPS will switch to bypass to supply power from

inverter. If the short-circuit is serious, the UPS input breaker and bypass breaker may trip out. After suffering the short-circuit fault, UPS will try to restart. If the short-circuit is removed, the UPS will switch to inverter; if the fault is not removed, the UPS will try to restart for 5 times. 5 times later, the UPS will turn to fault protection. At this time, it needs to power off or press the touch screen to shut down the UPS, and restart the UPS, and then, it will recover normal work.

Maintenance bypass mode

When the UPS needs to be maintained and the power supply for load cannot be interrupted, user can shut down the inverter and make the UPS works in bypass status, then switch on the maintenance bypass breaker and switch off the mains pint breaker and bypass power supply breaker. During the transforming of manual maintenance bypass, AC power is supplied for load by maintenance bypass breaker. At this time, the inner UPS has no electricity, maintainer can perform the maintenance safely.

2.3 Appearance and Structure

2.3.1 Appearance

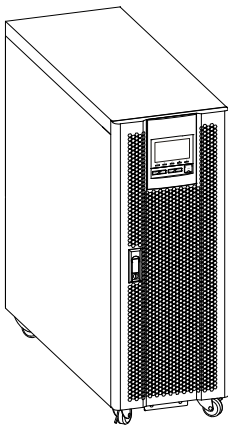

Figure2-2 Appearance of 10kVA, 20kVA, 30kVA, 40kVA

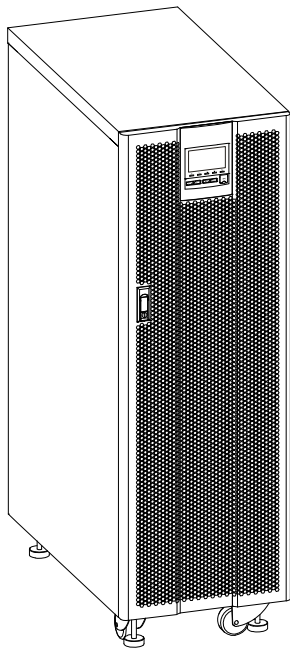

Figure2-3 Appearance of 50kVA, 80kVA, 100kVA, 140kVA, 140kVA

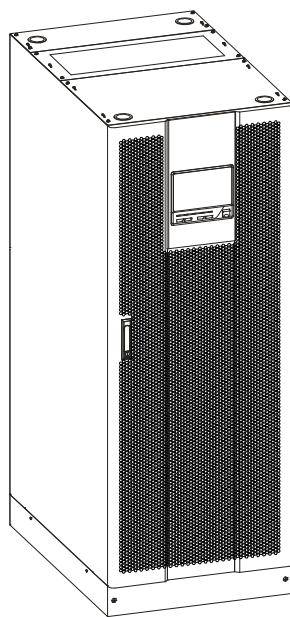

Figure2-4 Appearance of 160kVA, 200kVA

Operation panel

- IST7 series UPS (10kVA-140kVA)

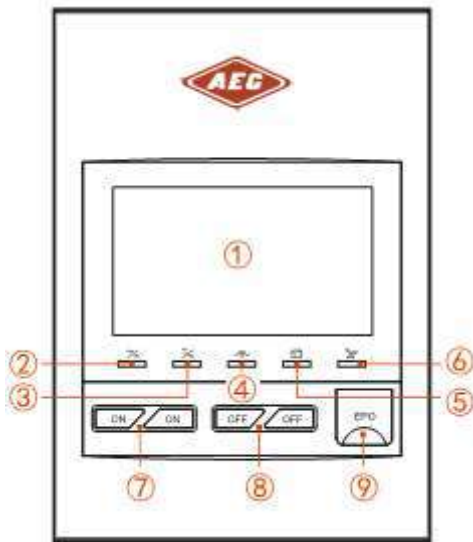

Figure2-5 Operation panel

- IST7 series UPS (160kVA-200kVA)

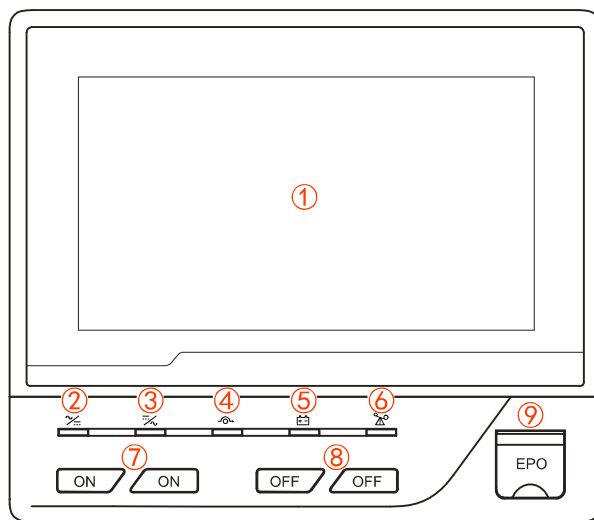

Figure2-6 Operation panel

Table2-1 Illustration for the operation panel

NO.	Name	Illustration
○,1	Touch screen	Shows the running parameters (such as voltage, current, load, etc.) and status

NO.	Name	Illustration
○,2	AC/DC indicator	On (green): rectifier works normally. On (red): rectifier abnormal.
○,3	DC/AC indicator	On (green): inverter works normally. On (red): inverter abnormal.
○,4	BYP. indicator	On (green): bypass output. On (red): bypass abnormal.
○,5	BATT. LOW indicator	On (red): battery is low-voltage.
○,6	OVERLOAD indicator	On (red): output is overload.
○,7	“ON” combination button	Press the two buttons for 3s, the system will power on.
○,8	“OFF” combination button	Press the two buttons for 3s, the system will power off.
○,9	EPO emergency power off button	Press the button, the system will power outage immediately.

2.3.2 Structure Layout (Open Door)

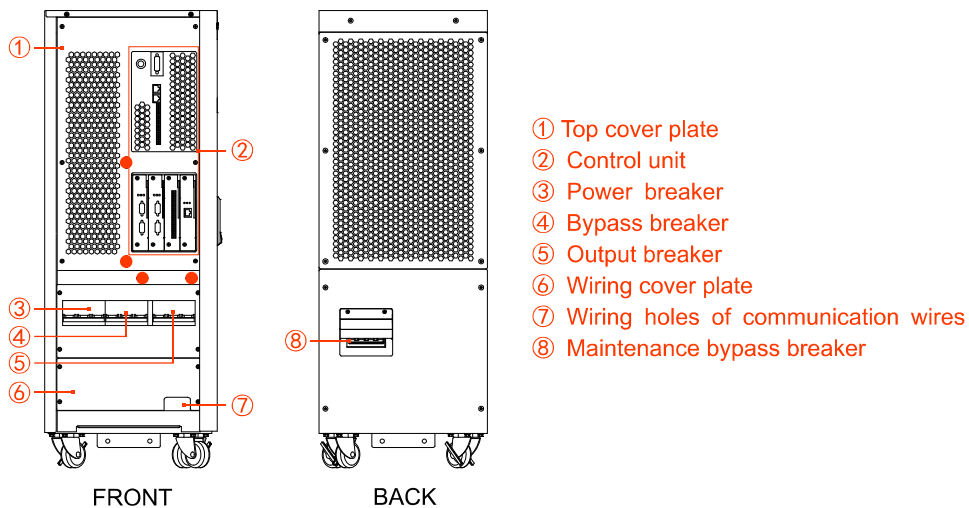

Figure2-7 Structure layout diagram of 10kVA, 20kVA, 30kVA, 40kVA

NOTE

The dots in above figure are the wiring bundling slots, which are used for fastening the communication wires.

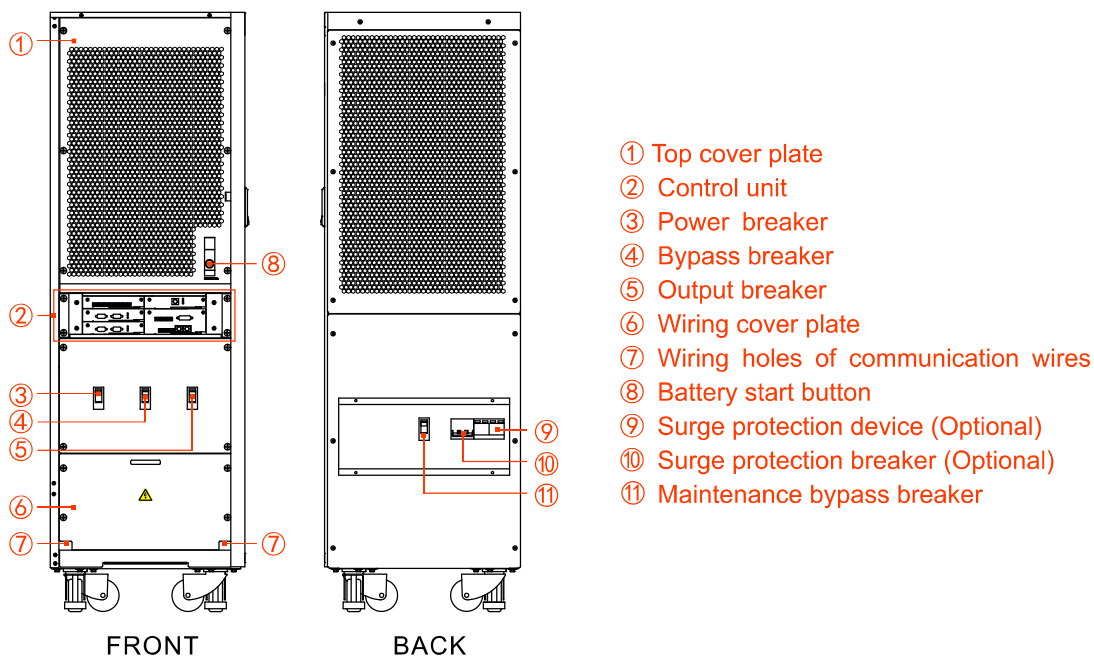

Figure2-8 Structure layout diagram of 50kVA, 80kVA, 100kVA, 140kVA, 140kVA

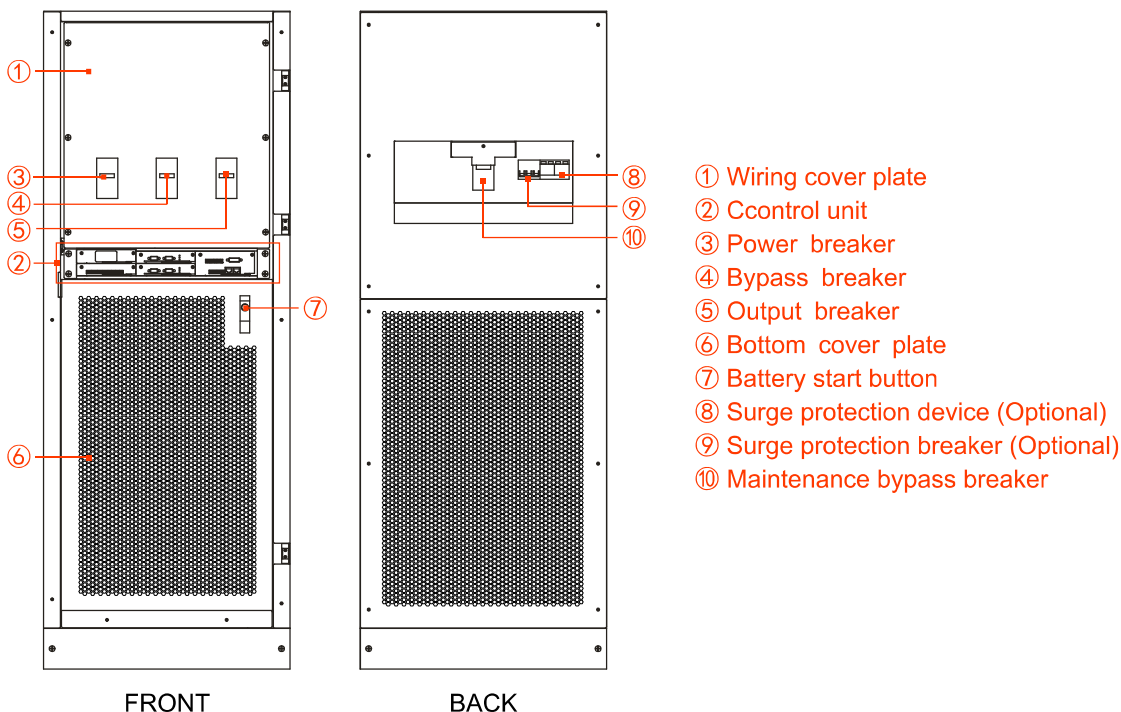
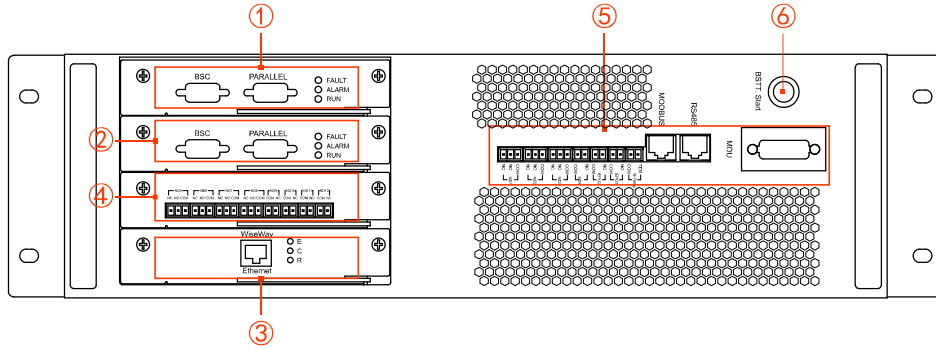

Figure2-9 Structure layout diagram of 160kVA, 200kVA

Control Unit

The control unit of IST7 series UPS is as shown in Figure2-10, Figure2-11, Figure2-12.



- ① Control card (master)
- ② Control card (minor) (optional)
- ③ SNMP card (optional)
- ④ Expansion dry contact card (optional)
- ⑤ System monitor card
- ⑥ Battery start button

Figure2-10 Control unit of 10kVA, 20kVA, 30kVA, 40kVA, 50kVA, 60kVA

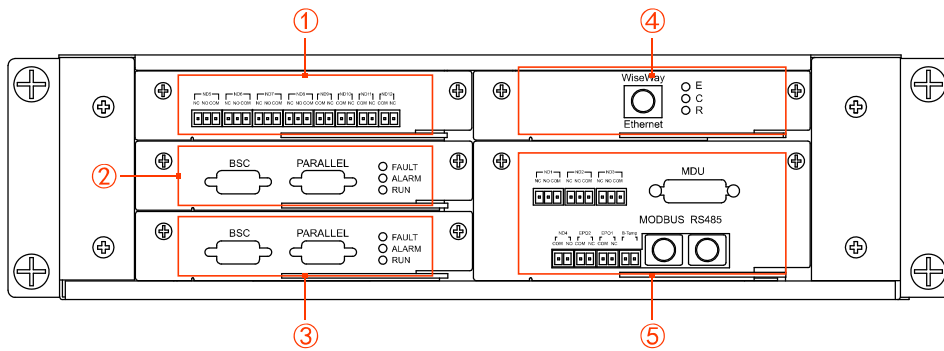

- ① Expansion dry contact board (optional)
- ② Control card (minor)(optional)
- ③ Control card (master)
- ④ SNMP card (optional)
- ⑤ System monitor card

Figure2-11 Control unit of 50kVA, 80kVA, 100kVA, 140kVA, 140kVA

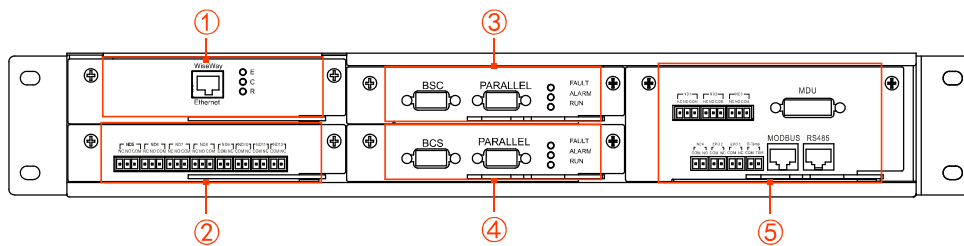

- ① SNMP card (optional)
- ② Expansion dry contact card (optional)
- ③ Control card (minor) (optional)
- ④ Control card (master)
- ⑤ System monitor card

Figure2-12 Control unit of 160kVA, 200kVA

- Expansion dry contact board (optional)

The expansion dry contact communication port includes 4 input dry contact communication signal and 3 output dry contact signal, detailed definition is as shown in Table2-2 and Table2-3.

Table2-2 Output dry contact function illustration

NO.	Silk-screen	Signal	Function illustration
1	ND5	It can be set to battery trip, output breaker, bypass output, start generator, sync/ async signal.	When the signal is valid, COM and NO is closed, COM and NC is opened. The allowable voltage-withstand is 250V/1A.
2	ND6		
3	ND7		
4	ND8		

Table2-3 Input dry contact function illustration

NO.	Silk-screen	Signal	Function illustration
1	ND9	It can be set to battery grounding	When the signal is valid, NO and COM is short circuited.
2	ND10		
3	ND11		
4	ND12	Reserved	

- Control card

The control card includes two ports: PARALLEL port is used for connecting the parallel UPS; BCS port is double-busbar system port.

- SNMP card and software (optional)

SNMP card is installed in the SNMP card insert slot of UPS or externally. It can realize remote management of the UPS through network. Detailed operation setting please see the user manual of network adapter.

- Monitor card

Monitor card includes two network ports: MODBUS port is used for the communication of MODBUS, RS485 port is used for the communication of RS485.

 **NOTE**

The definition for MODBUS port is as follows: pin3 is A, pin6 is B.

The definition for RS485 port is as follows: pin1 is A, pin8 is B.

Besides, the monitor card contains 6 standard dry contact ports (3 ports are input dry contact, the others are output dry contact), detailed definition is as shown in Table2-4, Table2-5.

Table2-4 Standard output dry contact illustration

NO.	Silk-screen	Signal	Function illustration
1	ND1	UPS FAULT signal	When the signal is valid, COM and NO is closed, COM and NC is opened. The allowable voltage-withstand is 250V/1A.
2	ND2	Mains FAIL signal	
3	ND3	BAT. LOW signal	

Table2-5 Standard input dry contact illustration

NO.	Silk-screen	Signal	Signal
1	EPO1	External EPO normal open input signal	When the signal is valid, NO and COM is short-circuit.
2	EPO2	External EPO normal closed input signal	When the signal is valid, NC and COM is open-circuit.
3	ND4	It can be set to external battery breaker or external maintenance bypass breaker.	When the signal is valid, NO and COM is short-circuit.

2.3.3 Alarm Function

Once the UPS abnormal, it will send sound & light alarm. Some alarm or protection function of the UPS is as shown in Table2-6.

Table2-6 Abnormal status and alarm/ protection function

Alarm action	Protection action	Fault name	
Buzzer long beeps, the red DC/AC indicator on.	Shut down all inverter output and bypass output.	EPO enable	
		Bypass overload protection	
		Bypass output under-voltage	
	Shut down all inverter output and turn to bypass output.		Inverter output overvoltage
			Inverter output under-voltage
			Inverter overload protection
			Parallel system sovereignty fault
			Parallel system communication abnormal
	Buzzer beeps quickly, the red BATT. LOW indicator on.	It is not allowed to supply power by battery or charge battery.	Battery over-voltage
			Battery circuit abnormal
None		Battery backup time is not enough	
It is not allowed to supply power by battery.		Battery discharge protection time is up.	
		Battery under-voltage.	
None		Battery low-voltage alarm	
Buzzer beeps slowly, the red BYP. indicator on.	Bypass output is not allowed.	Bypass power down.	
		Bypass over-voltage.	
		Bypass under-voltage.	
		Bypass over-frequency.	
		Bypass under-frequency.	
		Bypass phase sequence is wrong.	
		Bypass lack-phase.	
Buzzer beeps	None	Output circuit abnormal.	

Alarm action	Protection action	Fault name
slowly.		Output current DC component is too large.
		System card without redundancy.
		Environment temperature is too high
		Generator fails to start.
		Generator fails to shut down.
		The communication with touch screen abnormal.
		The communication of cabinet inner busbar 1 abnormal
		The communication of cabinet inner busbar 2 abnormal
		The communication of cabinet inner busbar 3 abnormal
		BSC synchronization wire abnormal
	Battery low-temperature alarm	
	The static startup is not allowed.	PFC software version is inconformity
		INV software version is inconformity
		System card X-software version is inconformity
		The parallel address repeated.
		Cabinet amount is not right.
	ECO output is not allowed.	ECO voltage out of range
		ECO frequency out of range
	Mains power supply is not	Mains power down.

Alarm action	Protection action	Fault name
	allowed.	Mains over-voltage.
		Mains under-voltage.
		Mains voltage unbalance is too large.
		Mains over-frequency.
		Mains under-frequency.
		Mains phase sequence is wrong.
		Mains lack-phase.
		Mains over-current.
		Mains current DC component is too large.
	Charge is not allowed.	Battery over-temperature



CAUTION

After the protection for battery under-voltage, once mains recover to normal power supply, the UPS will restart and charge the batteries.

3 Installation



CAUTION

The UPS should be installed by authorized person who is special trained and achieve the qualification of high-voltage and AC power.

The UPS is just suitable for installing on the concrete or nonflammable surface.

3.1 Installation Procedure

The installation procedure of the UPS is as shown in Figure3-1.

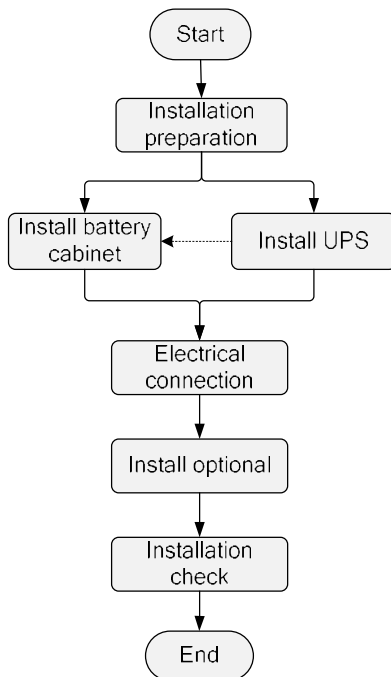

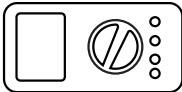

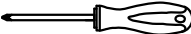
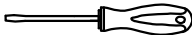

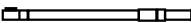



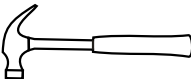
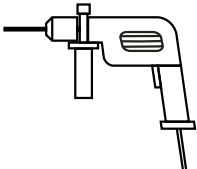

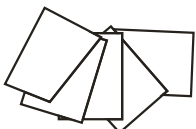
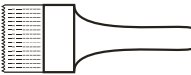
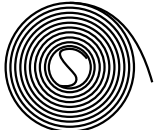
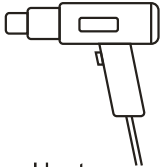
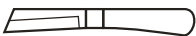
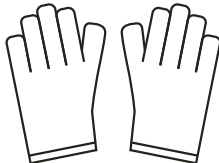
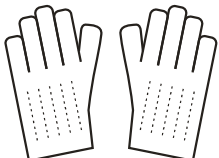
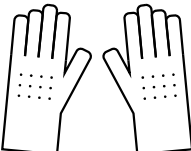



Figure3-1 Installation procedure

3.2 Installation Preparation

3.2.1 Installation Tools

Tools			
			
Clamp meter	Multi-meter	Label paper	Phillips screwdriver
			
Flat-head screwdriver	Socket wrench	Adjustable wrench	Torque wrench
			
COAX crimping tool	Diagonal pliers	Wire stripper	Claw hammer
			
Hammer drill	Insulation tape	Cotton cloth	Brush
			
Heat shrink tubing	Heat gun	Electrician's knife	Protective gloves
			
ESD gloves	Insulated gloves	Hydraulic pliers	Cable tie

**CAUTION**

The installation tools should be with isolated operation, which is to avoid electric shock.

3.2.2 Installation Environment

- Do not install the UPS in the place where exceeds the provision of technology index (temperature: 0°C~40°C, relative humidity: 0%~95%).
- It is strictly prohibit installing the UPS in the environment with metal conductive dust.
- Do not install the UPS in the open air, and the installation environment should meet the provision requirements.
- Basic requirements for power supply:
 - Grounding preparation. Ensure that the grounding terminal is OK and the voltage between neutral wire and grounding wire should not exceed 5V.
 - Before installation, please ensure that the AC input voltage and mains input wire capacity meet the UPS requirements. And considering if there has current-carrying capacity descending caused by wire aging.
 - The mains input voltage range of the UPS is 80VAC-280VAC. The mains capacity should be greater than the max. input power of the UPS.
 - The selected breaker should not with leakage current protection.
- The installation environment of the UPS should be with good ventilation, and far away from water source, heat source and inflammable and explosive objects. Avoid installing the UPS in the place where has direct sunshine, dust, volatile gas, corrosive objects or high salt.
- The UPS is just suitable for using below 1000m. If the altitude exceed 1000m, it needs to decrease the rated power according to GB/T3859.2 to use.



CAUTION

The optimal operating temperature for batteries is 20–30°C. Operating at temperatures lower than 20°C will shorten the battery backup time, and operating at temperatures higher than 30°C will shorten the battery lifespan.

For safety, make sure that the external DC distribution circuit is configured with a bipolar disconnecting switch.

3.2.3 Installation Space

Maintain a clearance of at least 800mm from the front panel, side pane or rear panel of the UPS to the wall or adjacent device, and maintain a clearance of at least 800mm from the top of the UPS to ceiling, which is to ensure good ventilation, as shown in Figure3-2.

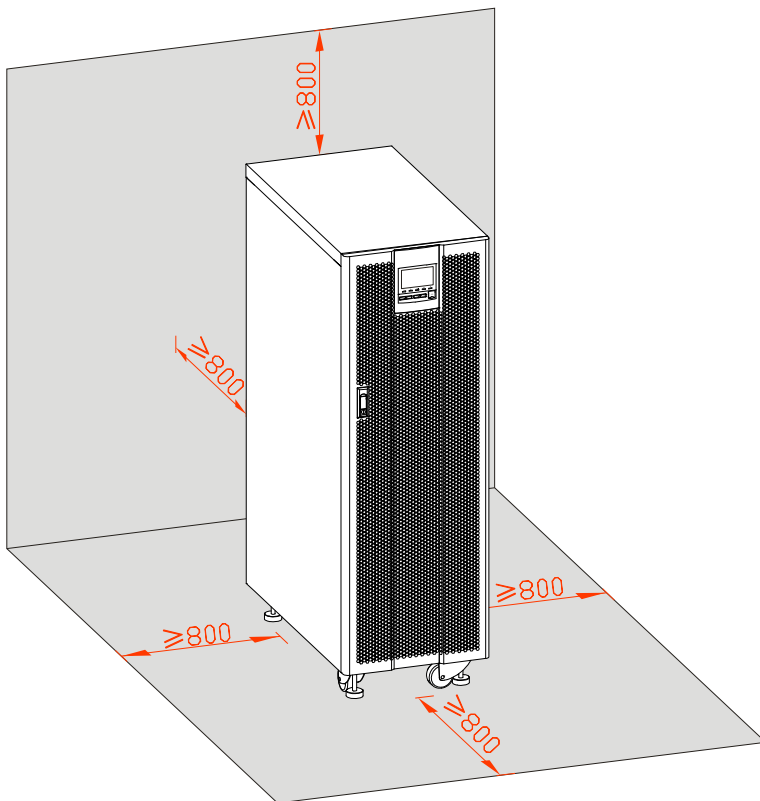

Figure3-2 Installation space (unit: mm)



NOTE

The installation space requirement of IST7 series UPS is the same. In above figure, we take 80kVA UPS as an example to illustrate.

- Avoid any object block the ventilation hole on the front panel and rear panel, which is to keep good ventilation for the UPS, or, it may rise the inner temperature, even influence the UPS service time.

3.2.4 Selection for Input and Output Wires

For the wire sectional area selection of AC input and output wires, please refer to Table3-1 and Table3-2 for corresponding recommended values, and choose upwards.

Table3-1 Recommended wire and terminal specification 1

Item		Model	10kVA	20kVA	30kVA	40kVA	50kVA	60kVA
Mains input	Mains input current (A)		25	40	55	71	95	111
	Recommend ed wire sectional area (mm ²)	U/V/W/N	4×4	4×10	4×16	4×16	4×25	4×35
	Wire terminal model		DT4	DT10	DT16	DT16	DT25	DT35
Bypass input	Bypass input current (A)		15	30	45	61	76	91
	Recommend ed wire sectional area (mm ²)	U/V/W/N	4×2.5	4×6	4×10	4×16	4×16	4×25
	Wire terminal model		DT2.5	DT6	DT10	DT16	DT16	DT25
Output	Output current(A)		15	30	45	61	76	91
	Recommend ed wire sectional area (mm ²)	U/V/W/N (when the load is non-linear load, the N wire should increase the wire sectional area)	4×2.5	4×6	4×10	4×16	4×16	4×25

Item		Model	10kVA	20kVA	30kVA	40kVA	50kVA	60kVA
		Wire terminal model			DT2.5	DT6	DT10	DT16
Battery input	Battery nominal discharge current (the current value of 384V voltage when standard equipped with 32 pieces 12V storage battery) (A)		28	55	82	110	137	164
	Battery max. discharge current (the current value when standard equipped with 32 pieces 12V storage battery stop discharge <each piece voltage is 10.5V>) (A)		35	63	94	125	157	188
	Recommended wire sectional area (mm ²)	+/N/-	3×6	3×10	3×16	3×35	3×50	3×70
	Wire terminal model		DT6	DT10	DT16	DT35	DT50	DT70
Grounding wire	Recommended wire sectional area (mm ²)	PE	4	10	16	16	16	25
	Wire terminal model		DT4	DT10	DT16	DT16	DT16	DT25

Table3-2 Recommended wire and terminal specification 2

Item		Model	80kVA	100kVA	140kVA	160kVA	200kVA
		Main	Mains input current (A)		138	190	207

Item			Model				
			80kVA	100kVA	140kVA	160kVA	200kVA
	Recommended wire sectional area (mm ²)	U/V/W/N	4×50	4×70	4×95	4×120	(4×95) ×2
	Wire terminal model		DT-50	DT-70	DT-95	DT-120	DT-95
Bypass input	Bypass input current (A)		122	152	182	244	304
	Recommended wire sectional area (mm ²)	U/V/W/N	4×35	4×50	4×70	4×95	(4×70) ×2
	Wire terminal model		DT-35	DT-50	DT-70	DT-95	DT-70
Output	Output current(A)		122	152	182	244	304
	Recommended wire sectional area (mm ²)	U/V/W/N(when the load is non-linear load, the N wire should increase the wire sectional area)	4×35	4×50	4×70	4×95	(4×70) ×2
	Wire terminal model		DT-35	DT-50	DT-70	DT-95	DT-70
Battery input	Battery nominal discharge current (the current value of 384V voltage when standard equipped with 32 pieces 12V storage battery) (A)		219	274	329	438	548

Item		Model	80kVA	100kVA	140kVA	160kVA	200kVA
	Battery max. discharge current (the current value when standard equipped with 32 pieces 12V storage battery stop discharge <each piece voltage is 10.5V>) (A)		253	314	380	506	760
	Recommended wire sectional area (mm ²)	+/N/-	3×95	3×120	3×150	(3×95) ×2	(3×120) ×3
	Wire terminal model		DT-95	DT-120	DT-150	DT-95	DT-120
Grounding wire	Recommended wire sectional area (mm ²)	PE	25	50	50	50	50
	Wire terminal model		DT-25	DT-50	DT-50	DT-50	DT-50

3.2.5 Surge Protection Device

If the UPS is installed in a lightning-prone area, it's better to install multiple surge protection devices between the power grid and the UPS. The UPS can be equipped with the surge protection device of grade-C. If the UPS is installed outdoors, it requires a higher surge protection level than those installed indoors.

3.2.6 Reverse Feedback Protection (Optional)

It is suggested to add the contactor with 220V AC coil at the AC power distribution side as the reverse feedback protection device.

3.3 Transportation and Unpacking

3.3.1 Transportation



CAUTION

The UPS should be transported by trained professional.

During transporting, please take care and avoid impact or falling off.

If the UPS needs to be stored for a long time after unpacking, it is suggested to package the UPS with original plastic bag.

The UPS can be transported by motor-driven forklift (as shown in Figure3-3) or manual forklift (as shown in Figure3-4). While lifting, please keep the UPS center of gravity at that of the forklift and move slowly and stably.



Figure3-3 Motor-driven forklift

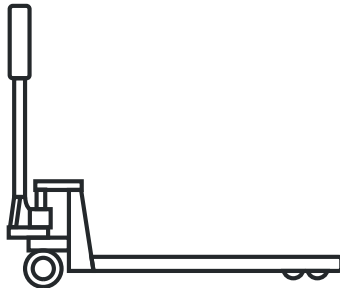

Figure3-4 Manual forklift



CAUTION

When lifting, pay attention to the balance and stable of the UPS.

During moving, keep the UPS vertical and do not put down or uplift suddenly.

3.3.2 Unpacking

IST7 series UPS (10kVA-140kVA)

- Step 1 Check if the package appearance is in good condition and if there is any damage caused by transportation. If damaged, please inform the carrier immediately.
- Step 2 Transport the UPS to assigned site.

Step 3 Unpack the external package, remove the foam pad and plastic bag, and take out the accessories.

Step 4 Check the UPS.

- Inspect the appearance of the UPS and check if there has any damage caused by transportation. If any damage, please inform the carrier immediately.
- Compare with the packing list and check if the accessories mode is complete and proper. If the accessories lack or model wrong, please take note and contact the our company or local agency of our company.

Step 5 Dismantle the 4 fasten bolts of bottom supporting plate and UPS, and 4 fasten bolts of wooden bracket and bottom supporting plate, and then, remove the supporting plates, as shown in Figure3-5.

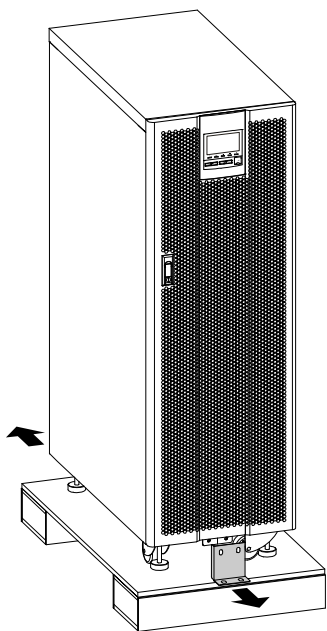

Figure3-5 Remove bottom supporting plates

 **NOTE**

The bottom supporting plates of the UPS are the same, In above figure, we take 80kVA as an example to illustrate.

Step 6 Loosen the brake of all the wheels or heighten the 4 supporting feet (as shown in Figure3-6).

 **NOTE**

The wheels of 10kVA, 20kVA, 30kVA, 40kVA, 50kVA, 60kVA is equipped with brake, the wheels of 50kVA, 80kVA, 100kVA, 140kVA, 140kVA is equipped with supporting foot.

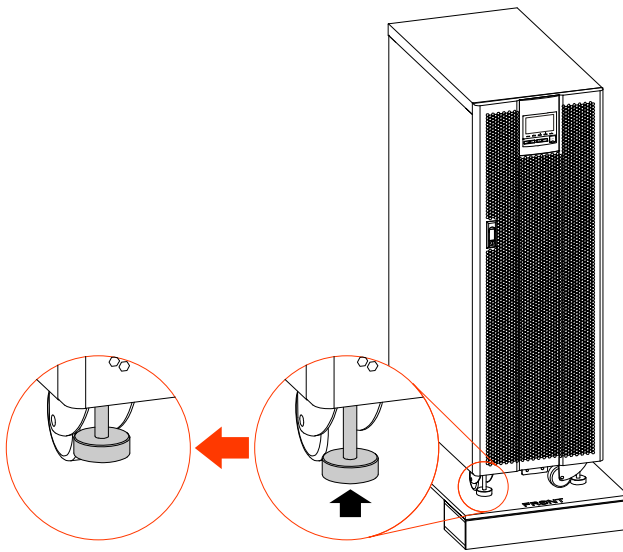

Figure3-6 Adjust supporting feet

- Step 7 Put the tilting plate to the front of the UPS, and keep the higher end of the sliding plate close to the wooden bracket, and move the UPS to ground slowly, as shown in Figure3-7.

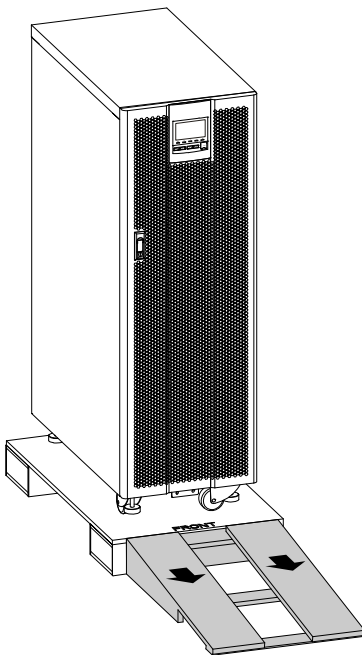

Figure3-7 Place the sliding plate

 **NOTE**

The operation for the sliding plate of the UPS are the same, In above figure, we take 80kVA as an example to illustrate.

**CAUTION**

During moving, it needs to operate by two people (one at left side and one at right side) to avoid tilting or human injury.

----End

IST7 series UPS (160kVA-200kVA)

- Step 1 Check if the package appearance is in good condition and if there is any damage caused by transportation. If damaged, please inform the carrier immediately.
- Step 1 Transport the UPS to assigned site.

**CAUTION**

To avoid tilting during transportation, keep the UPS centre of gravity at the centre of forklift arms and keep the forklift arm go beyond the wooden bracket.

- Step 2 Unpack the external package, remove the foam pad and plastic bag, and take out the accessories.
- Step 3 Check the UPS.
- Inspect the appearance of the UPS and check if there has any damage caused by transportation. If any damage, please inform the carrier immediately.
 - Compare with the packing list and check if the accessories mode is complete and proper. If the accessories lack or model wrong, please take note and contact the our company or local agency of our company.
- Step 4 Dismantle the bottom cover plates (as shown in Figure3-8), and unscrew the bolts that fasten the UPS and wood bracket, and then remove the bolts (as shown in Figure3-9).

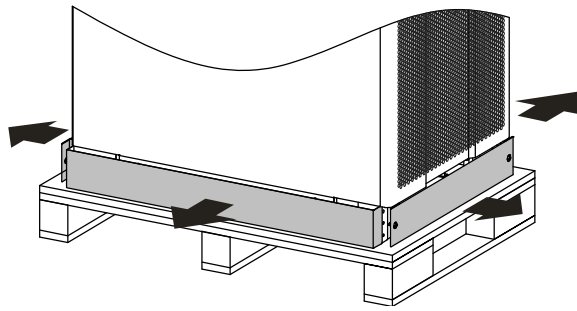

Figure3-8 Remove bottom cover plates

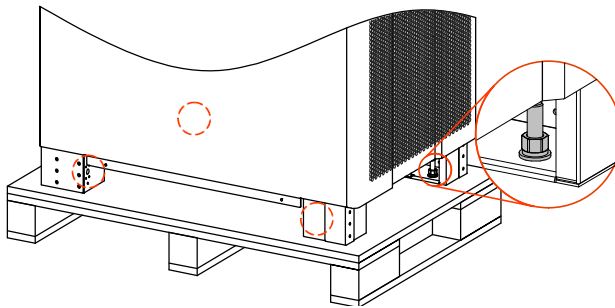

Figure3-9 Bolts position

----End

3.4 Mechanical Installation

3.4.1 UPS Installation

IST7 series UPS (10kVA-140kVA)

Step 1 Determine and plan the installation position according to the UPS size (as shown inFigure3-11) and installation clearance requirement (see 3.2.3 Installation).

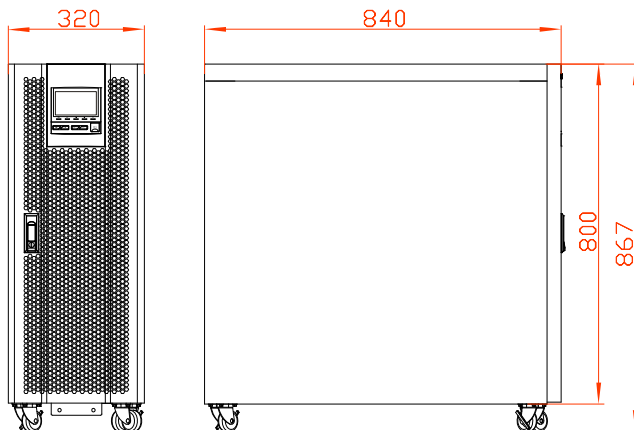

Figure3-10 Size of 10kVA, 20kVA, 30kVA, 40kVA

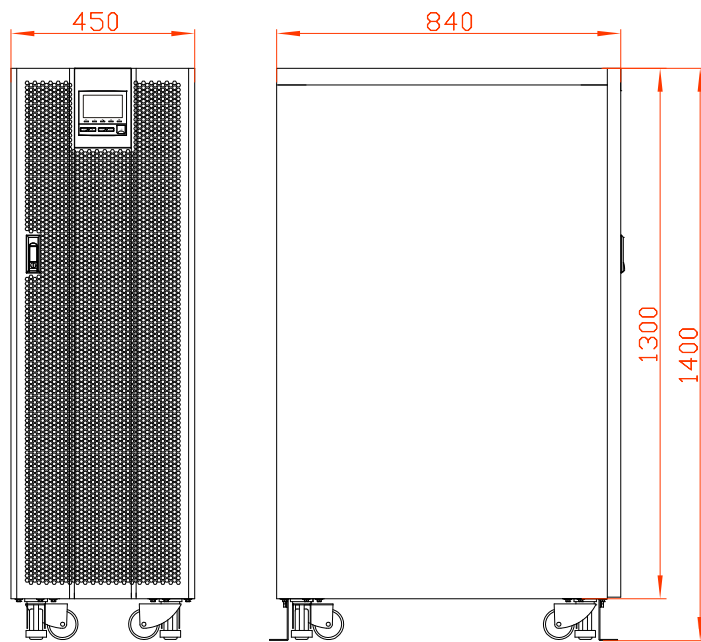

Figure3-11 Size of 50kVA, 80kVA, 100kVA, 140kVA, 140kVA

Step 2 Push the UPS to the installation site.



CAUTION

During moving the UPS to the ground, please move the device stably and avoid device tilting.

Step 3 Lock the brake on all the wheels or adjust each supporting feet.

- For 10kVA, 20kVA, 30kVA, 40kVA, 50kVA, 60kVA, lock the brake on all the wheels to ensure the UPS cannot move at will.
- For 80kVA, 100kVA, 140kVA, adjust each supporting feet to parallel the supporting feet with ground, as shown in Figure3-12.

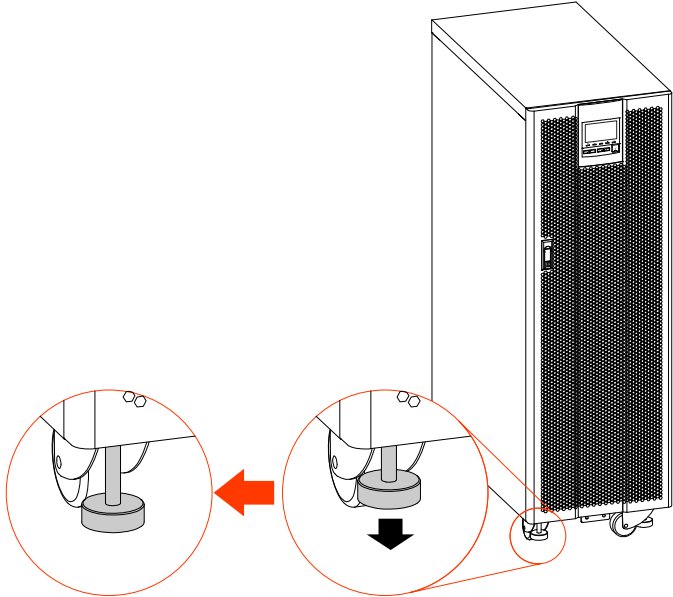

Figure3-12 Adjust supporting feet

NOTE
For 80kVA, 100kVA, 140kVA, after adjusting the supporting feet, please check the installation and see if the UPS is horizontal, if not, please adjust it till horizontal.

----End

IST7 series UPS (160kVA-200kVA)

Step 1 Determine and plan the installation position according to the UPS size (as shown in Figure3-13) and installation clearance requirement (see 3.2.3 Installation).

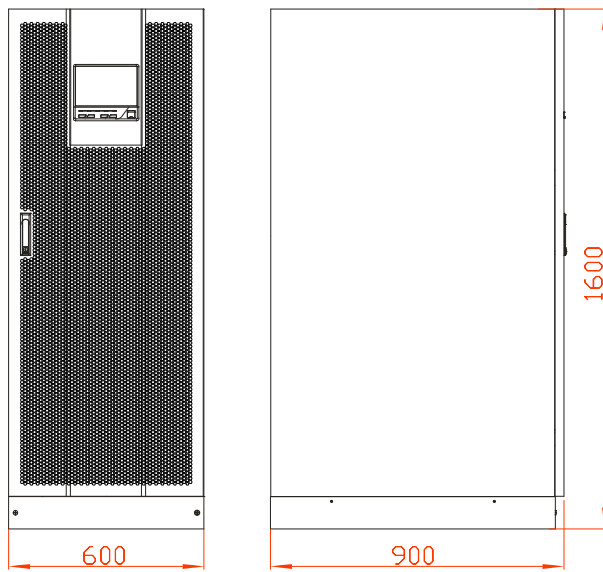

Figure3-13 Size of 160kVA, 200kVA

Step 2 Drill 4 holes of $\Phi 13$ by hammer drill according to the installation size of pedestal (as shown in Figure3-14).

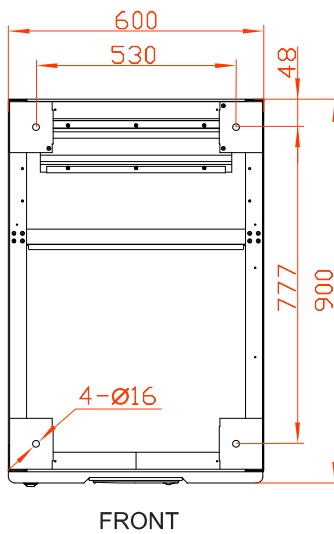
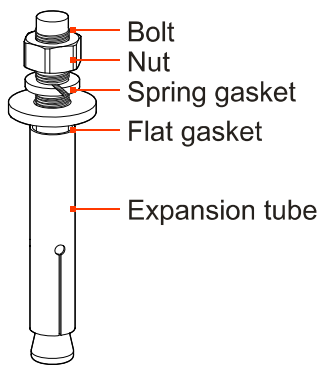

Figure3-14 Bottom installation size (bottom view of pedestal)

Step 3 Install 4 expansion bolts M12 into the installation holes. The structure and installation of the expansion bolt is as shown in Figure3-15.



1. Drill holes on the installation ground by hammer drill.
2. Tighten The expansion bolts mildly, and put it to the hole vertically, and then knock the expansion bolt by rubber hammer till all the expansion tube into the hole.
3. Pre tighten the expansion bolt.
4. Screw out the bolt , take down the spring gasket and flat gasket.

Figure3-15 Structure and installation of the expansion bolts



CAUTION

The expansion tube shouldn't be higher than the ground, which is to avoid affecting the installation.



NOTE

The exposed height of expansion bolt must be within 50mm.

Step 4 Move the UPS from wooden bracket to the ground, and align the bottom installation hole with the expansion bolt, and screw the bolts.

Step 5 Reinstall the bottom cover plates.

----End

3.4.2 Wiring

IST7 series UPS (10kVA-140kVA)

Step 1 Open the front door of the UPS, remove the bottom wiring cover plate, as shown in Figure3-16.



CAUTION

The battery +, - and neutral wire terminal of 10kVA, 20kVA, 30kVA, 40kVA, 50kVA, 60kVA are all at the back of the UPS, so, before wiring, it needs to dismantle the rear bottom wiring cover plate.

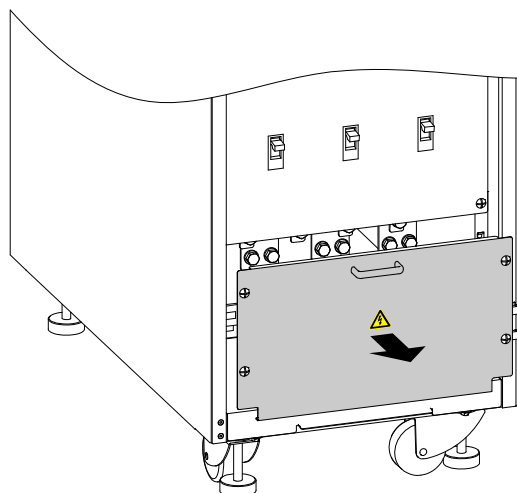

Figure3-16 Remove bottom wiring cover plate



NOTE

The bottom wiring cover plate position of the UPS are the same, In above figure, we take 80kVA UPS as an example to illustrate.

Step 2 Lead the input cables, output cables and battery cables go through the bottom wiring hole, and connect the cables, then fasten the bolts.

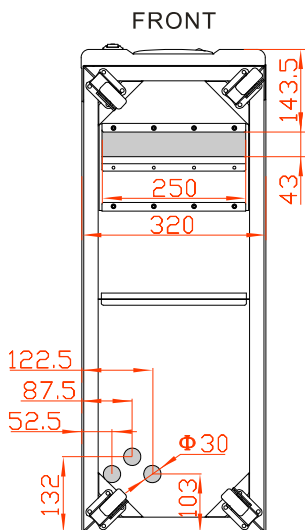

Figure3-17 Bottom wiring holes diagram of 10kVA, 20kVA, 30kVA, 40kVA

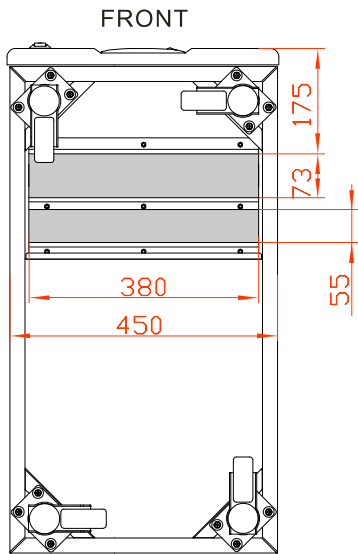

Figure3-18 Bottom wiring holes diagram of 50kVA, 80kVA, 100kVA, 140kVA, 140kVA



CAUTION

While wiring, ensure that the input and out wires are reliably connected with input and output terminal, and do not reverse connect or bad connect.

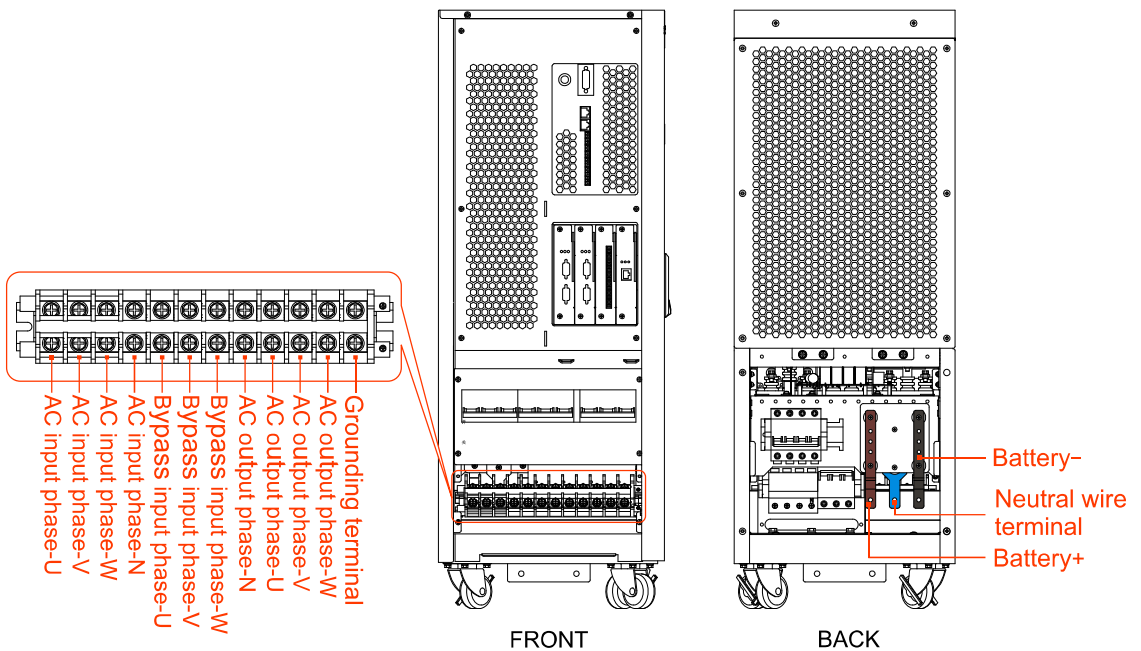

Figure3-19 Wiring terminals diagram of 10kVA, 20kVA, 30kVA, 40kVA

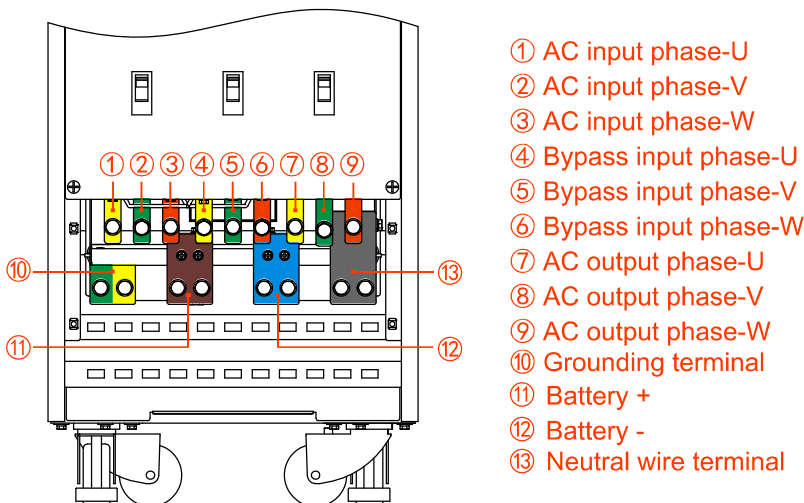

Figure3-20 Wiring terminals diagram of 50kVA, 80kVA, 100kVA, 140kVA, 140kVA



CAUTION

When wiring, ensure that the connection between input, output wire and input, out terminal is reliably, avoid bad connection or wrongly connection.

It is suggested to select DC breaker for battery DC input, the detail wiring is as shown in Figure3-21.

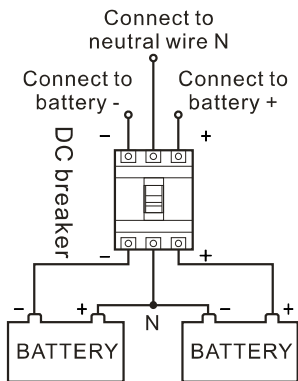

Figure3-21 Battery wiring diagram

Step 3 Lead the communication wires go through the bottom wiring hole and connect them to corresponding ports and ensure reliable connection.



NOTE

Fasten the communication wires to corresponding wiring bundling slot by cable ties, which is to ensure wiring in order and avoid blocking the ventilation holes.

Step 4 After ensure the wire connection are all right, fill the empty party with insulation fireproofing mud.

Step 5 Reinstall the bottom wire seal plate, the wiring is finished.

----End

IST7 series UPS (160kVA-200kVA)

Step 1 Remove the back top wiring cover plate, as shown in Figure3-22.

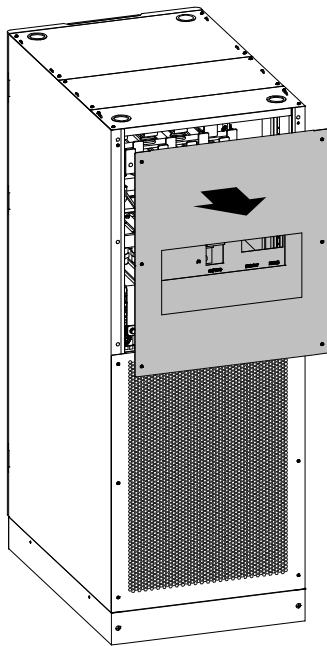

Figure3-22 Remove the back top wiring cover plate

Step 2 Lead the input cables, output cables and battery cables go through the top wiring hole, and connect the cables according to Figure3-23 respectively, then fasten the bolts.



CAUTION

When wiring, ensure that the connection between input, output wire and input, out terminal is reliably, avoid bad connection or wrongly connection.

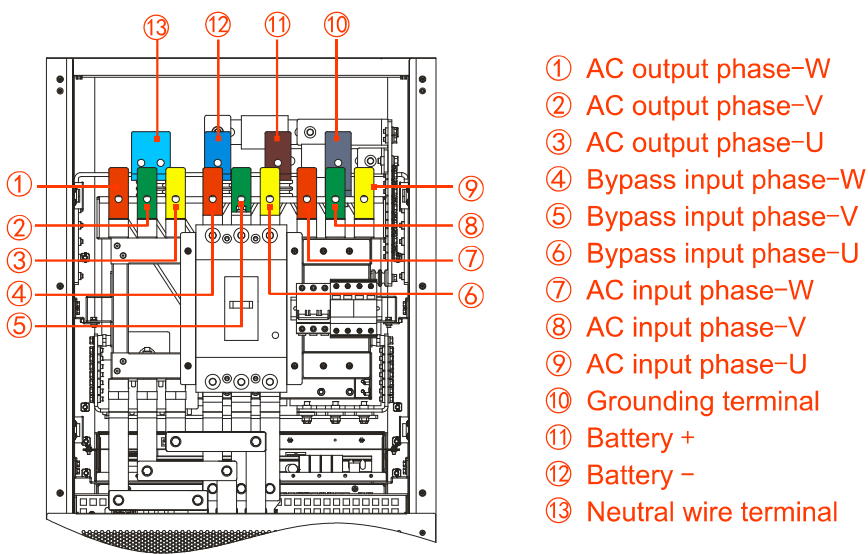

Figure3-23 Wiring terminals diagram of 160kVA, 200kVA (back view)

When selecting down wiring, the corresponding wiring diagram is as shown in Figure3-24.

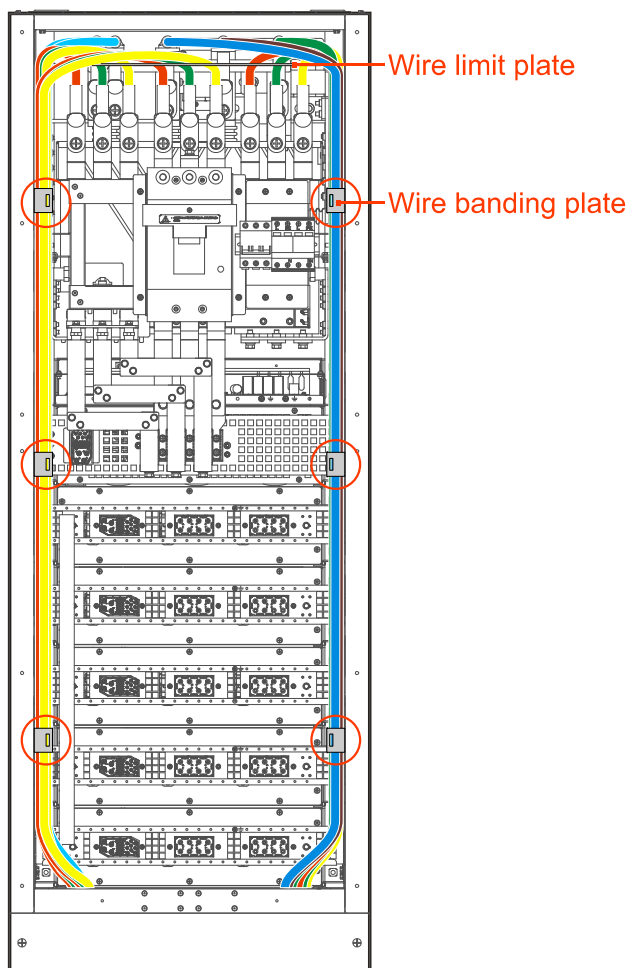

Figure3-24 Down wiring diagram

NOTE

While down wiring, the wires needs to go across the upper wire limit plate, and fasten them by the wire banding plates.

**CAUTION**

When wiring, ensure that the connection between input, output wire and input, out terminal is reliably, avoid bad connection or wrongly connection.

It is suggested to select DC breaker for battery DC input, the detail wiring is as shown in Figure3-25.

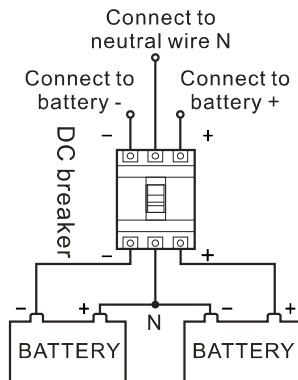

Figure3-25 Battery wiring diagram

- Step 3 After ensure the wire connection are all right, fill the empty party with insulation fireproofing mud.
- Step 4 Reinstall the bottom wire seal plate, the wiring is finished.

----End

3.4.3 Install Battery Cabinet

Important safety rule



DANGER

Do not open or disassemble the battery, for the inner electrolyte is harmful for eyes. If contacting the electrolyte with carelessness, please wash the contact part with plenty water and go to hospital immediately.

To avoid electric shock and short circuit while replacing battery, pay attention to following precautions.

- Do not wear watch, ring or other metal decorations.
- Use the tool with insulation handle.
- Do not put any tool or metal object on the battery.
- Keep the battery far away from fire, no smoking.

Battery cabinet installation procedure



CAUTION

The assemble for the external battery should be performed by professional technician.

Besides the UPS, it is necessary to equip battery and battery cabinet. The installation procedure for battery cabinet is as follows.

- Step 1 Connect the wires of external batteries properly.



CAUTION

Before connecting, please ensure that the breaker of battery cabinet is not connected to the terminal bar of the UPS.

- Step 2 After disconnecting the battery breaker, connect the power wire of battery breaker to the anode, cathode and neutral wire N of the UPS correspondingly. Ensure that the polarity and voltage meet the specification requirement, and then close the breaker between the UPS and batteries.

----End

After assembly and test, the UPS can put into use.

3.5 System Check and Test

3.5.1 Check Electrical Connection

After finishing the electrical connection, check the following items.

Table3-3 Check list

No.	Check item	Result
1	Check if the colour of AC cables is in accordance with the specification.	Yes <input type="checkbox"/> No <input type="checkbox"/>
2	Check if the wiring of cabinet is firmly.	Yes <input type="checkbox"/> No <input type="checkbox"/>
3	Check if the safety identification of AC power distribution unit is complete.	Yes <input type="checkbox"/> No <input type="checkbox"/>
4	Check if the wire connection point is firmly.	Yes <input type="checkbox"/> No <input type="checkbox"/>
5	Check if the battery is connected in right polarity and sequence.	Yes <input type="checkbox"/> No <input type="checkbox"/>
6	Check if the cable identification is correct.	Yes <input type="checkbox"/> No <input type="checkbox"/>
7	Check if the wiring is neat, and if the cable connection is in accordance with the specification.	Yes <input type="checkbox"/> No <input type="checkbox"/>
8	Check if the equipment installation and wiring is advantageous to the transformation, expansion and maintenance of the system in the future.	Yes <input type="checkbox"/> No <input type="checkbox"/>

3.5.2 UPS Test

Turn off the mains input switch to simulate the situation of mains fault. When mains fault, the UPS turns to battery inverter, the touch screen will show the alarm and the buzzer will beep every 1s.

3.5.3 Connect Load

After UPS starting and working stably, turn on the load. Start big-power devices before small-power ones. Some devices has large starting current which may cause overload protection (or bypass operation), it is better to start these equipment before others.

4 Touch Screen

4.1 Menu Hierarchy

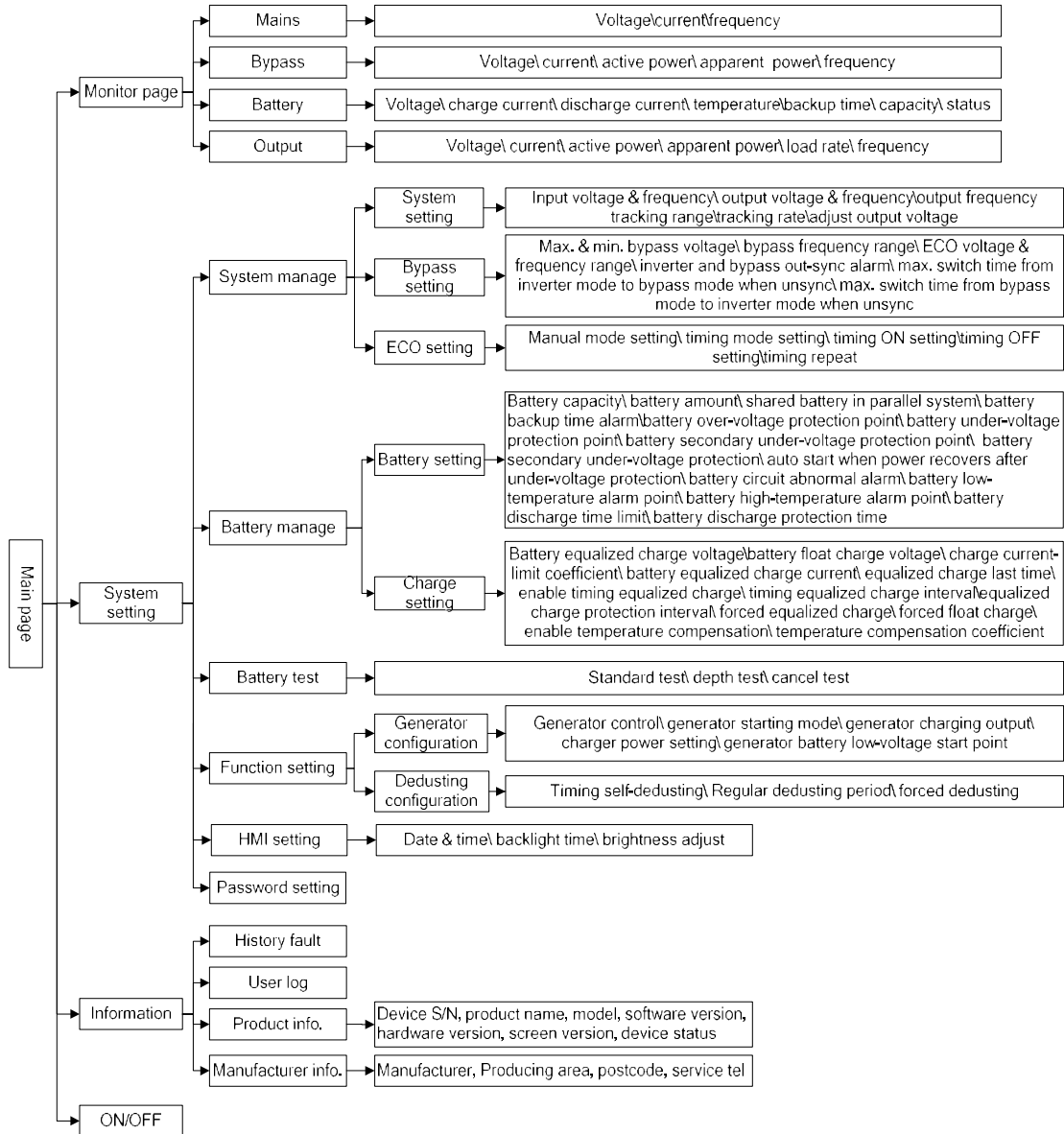

Figure4-1 Menu structure

 **NOTE**

IST7 series (10kVA-140kVA) UPS adopt 4.3 inch touch screen to display, IST7 series (160kVA-200kVA) UPS adopt 7 inch touch screen to display, the page structure is the same. In this chapter, we take the page of 4.3 inch touch screen as example to illustrate.

4.2 MainPage

After powering on, it will enter system monitor main page, as shown in Figure4-2.

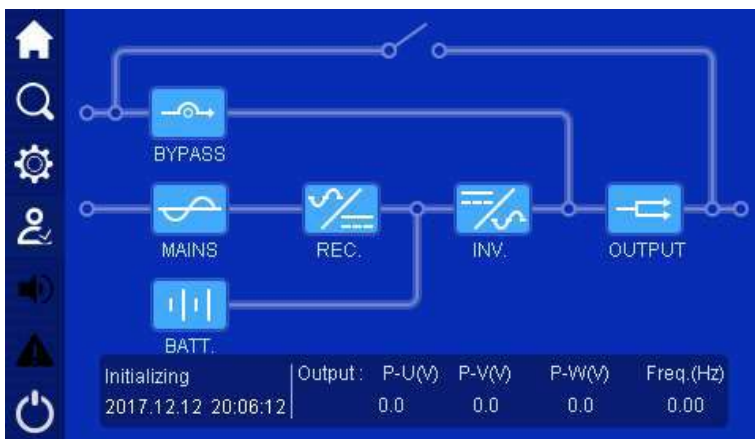















Figure4-2 Main page

After enter the mains page, user can monitor the system conveniently. The meaning of icon in main page is as follows.

- : System bypass input. When bypass input abnormal, the icon flickers and shows as .
- : System mains input. When mains input abnormal, the icon flickers and shows as .
- : Battery status. When battery abnormal, the icon flickers and shows as .
- : System output. When output abnormal, the icon flickers and shows as .
- : Back to homepage.
- : Information records.
- : System parameter setting.
- : Login.
- : Buzzer.

: Warning.

: ON/OFF.

The work status and energy flow on main page shows the system running status and unit running condition directly.

4.3 System Work Status Display

The system work status includes: initializing, shutdown, exit parallel system, maintenance bypass output, bypass output, battery inverter output, mains inverter output, grid-connected aging, ECO bypass output, frequency conversion INV. output, aging bypass output, fault protection. Each page is as shown from Figure4-3 to Figure4-14.

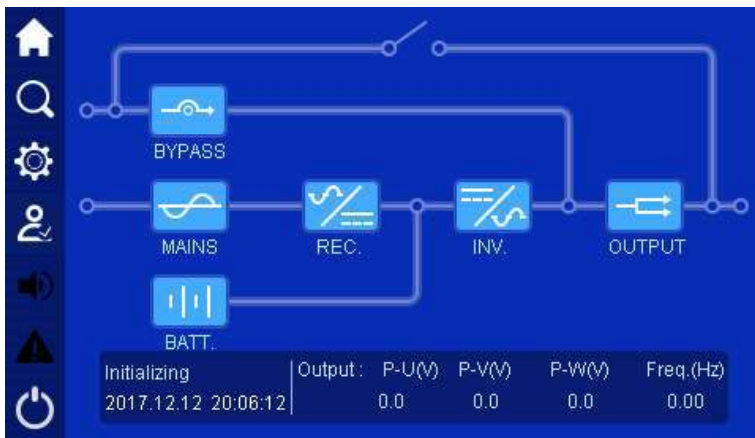

Figure4-3 Initializing

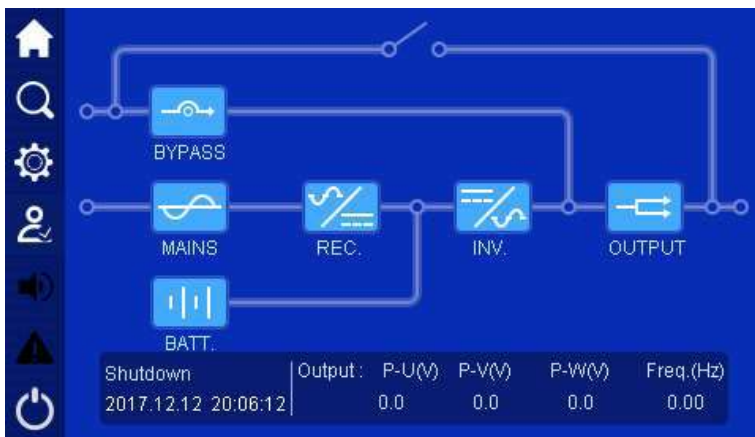

Figure4-4 Shutdown

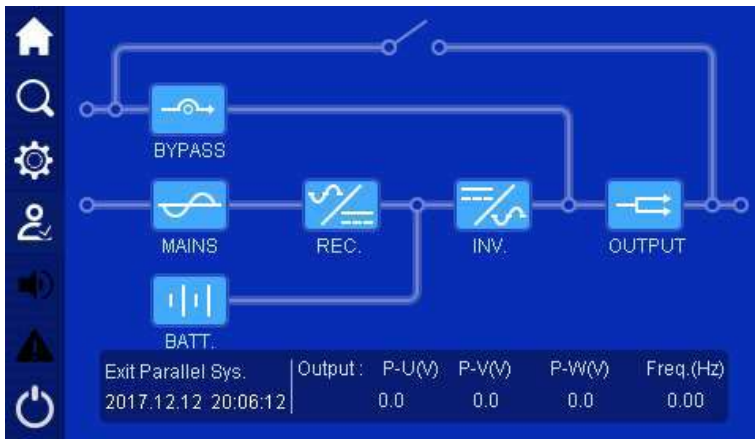

Figure4-5 Exit parallel system

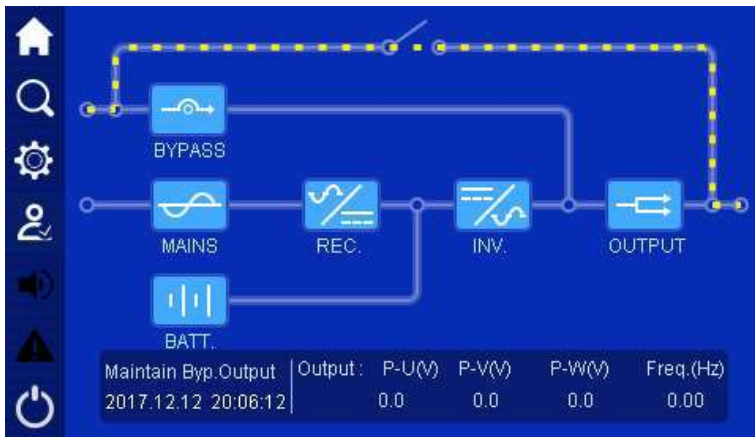

Figure4-6 Maintain bypass output

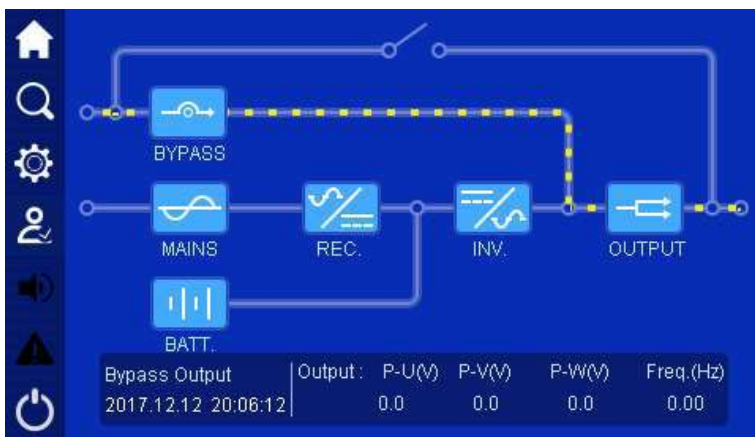

Figure4-7 Bypass output

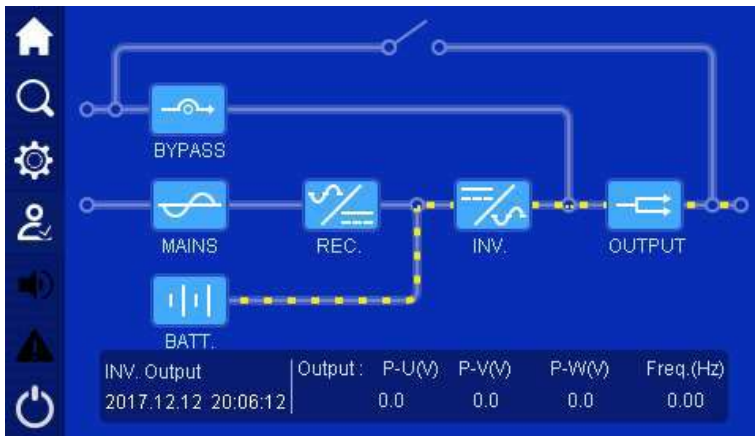

Figure4-8 Battery INV. output

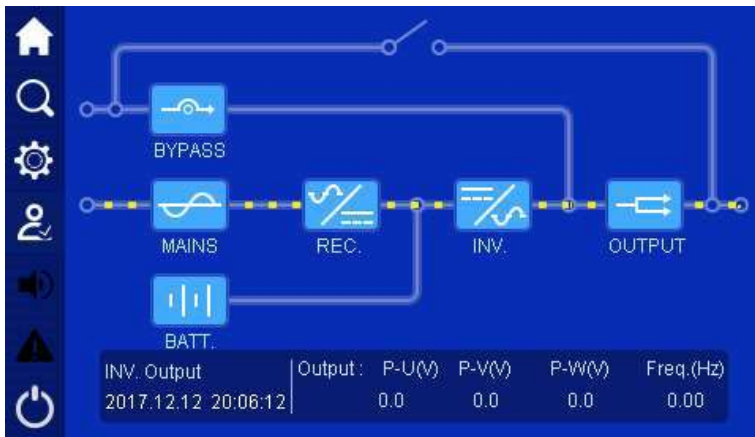

Figure4-9 Mains INV. output

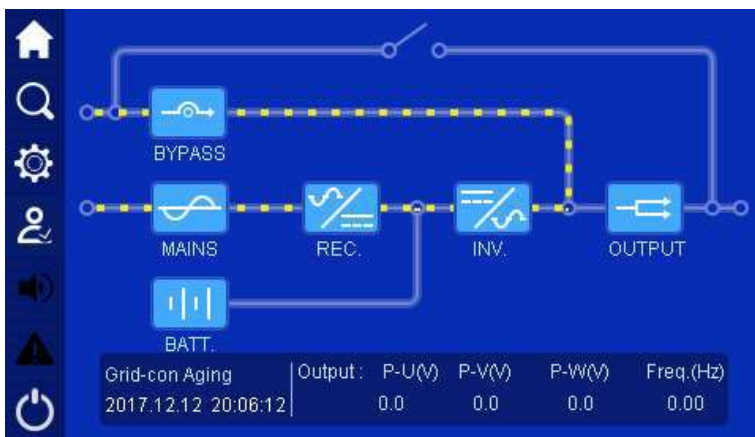

Figure4-10 Grid-connected aging

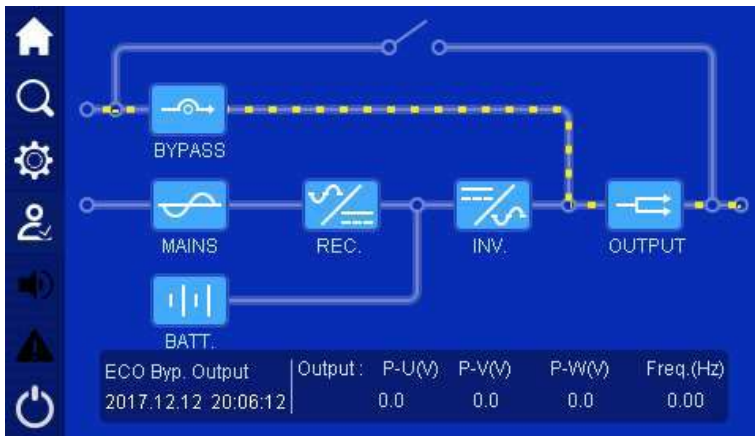

Figure4-11 ECO bypass output

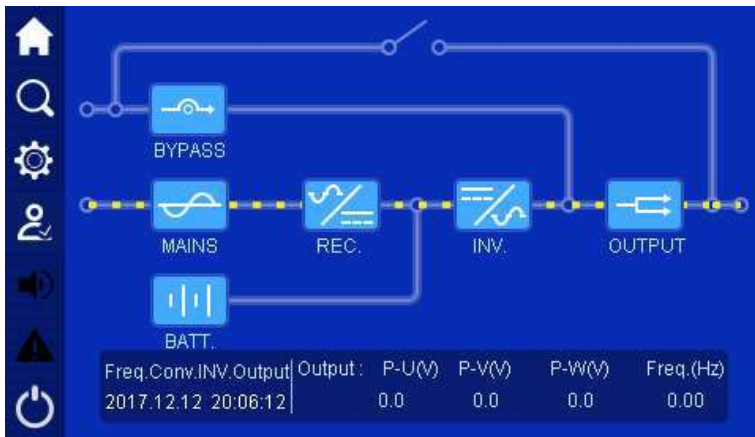

Figure4-12 Frequency conversion INV. output

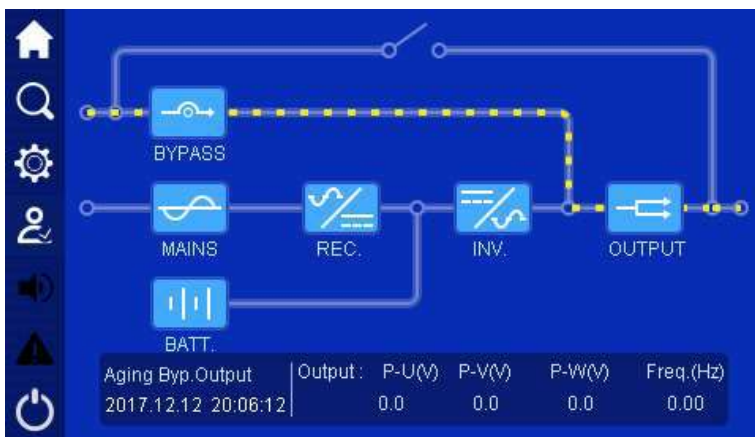

Figure4-13 Aging bypass output

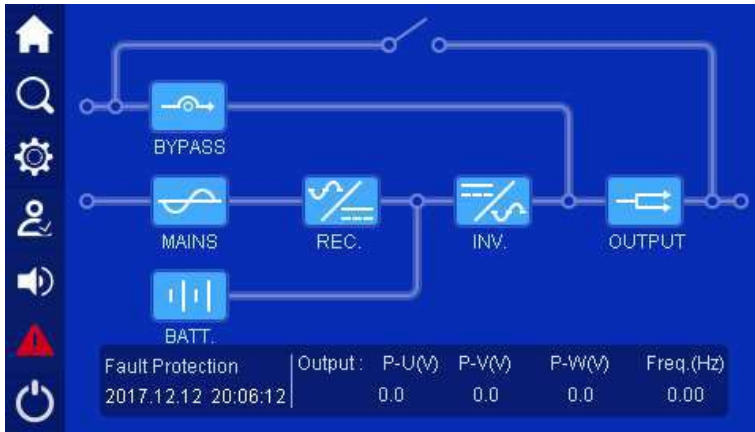



Figure4-14 Fault protection, without output

When unit or system abnormal, the left warning indicator  light on. Click the warning indicator, it will show the current fault, as shown in Figure4-15.

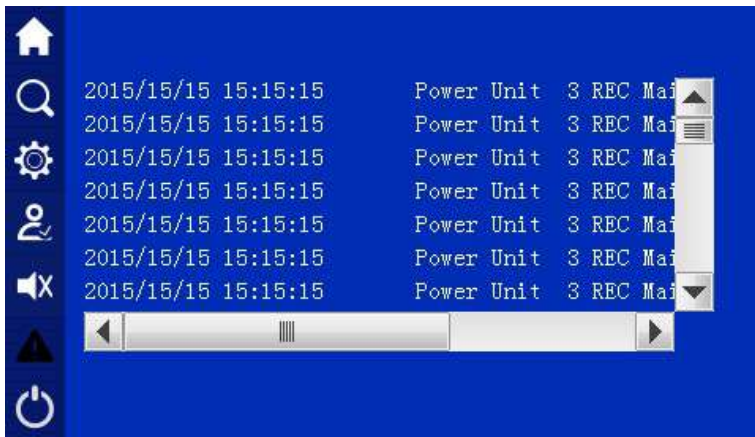



Figure4-15 Current fault window

4.4 Monitor Function

4.4.1 Bypass Input Information

In main page, click  icon, it will enter system bypass information page, as shown in Figure4-16. In the page, it shows the bypass three-phase voltage, current, active power, apparent power and frequency.

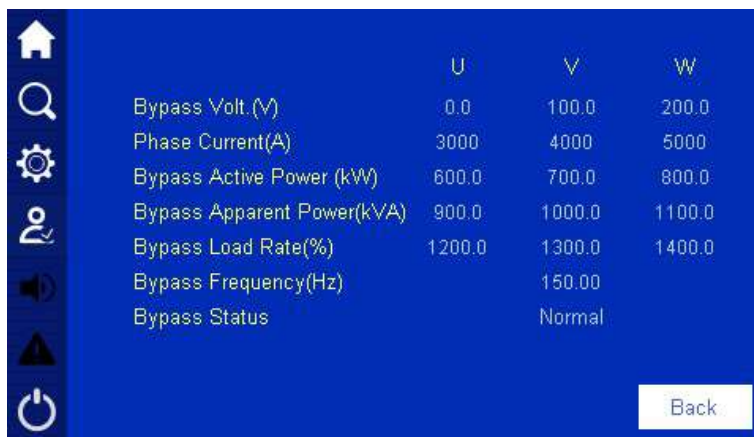



Figure4-16 Bypass information

4.4.2 Mains Information

In main page, click  icon, it will enter system mains information page, as shown in Figure4-17. In the page, it shows the current system mains three-phase voltage, current and frequency.

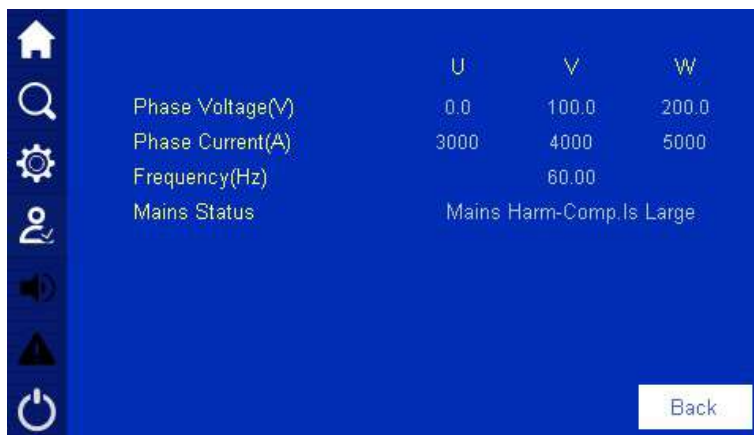



Figure4-17 Mains information

4.4.3 Battery Information

In main page, click  icon, it will enter battery information page. In the page, it shows the battery voltage of positive and negative battery group, battery charge/discharge current, battery remaining capacity, battery remaining time, battery temperature, battery status, as shown in Figure4-18 and Figure4-20.

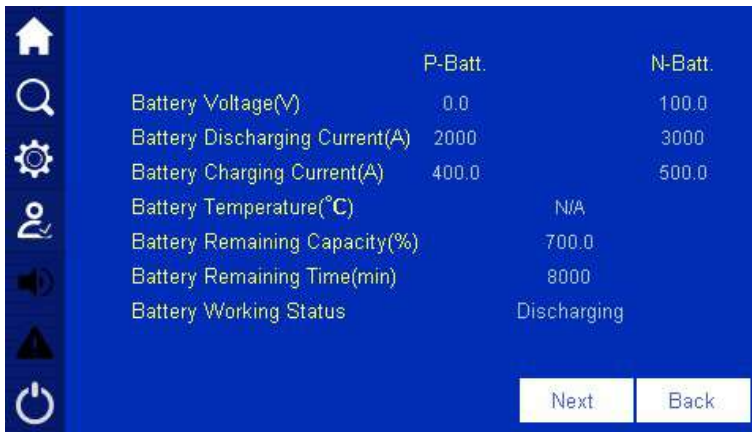

Figure4-18 Battery inversion status, battery discharge 1

When the battery type in battery management page is set to iron-lithium battery, the battery information also includes the content shown in Figure4-19.

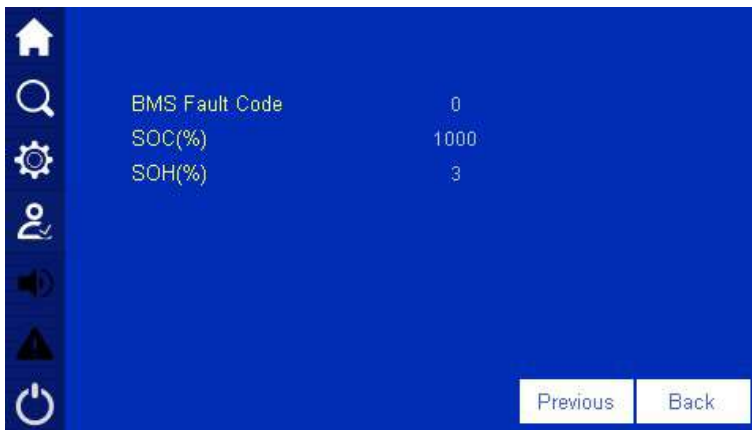

Figure4-19 Battery inversion status, battery discharge 2

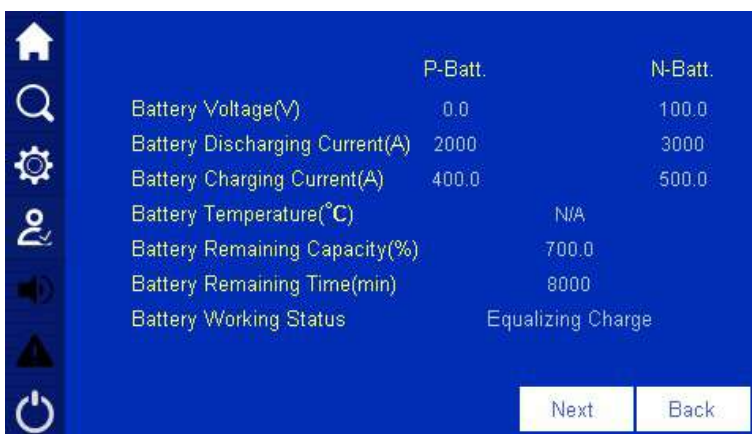

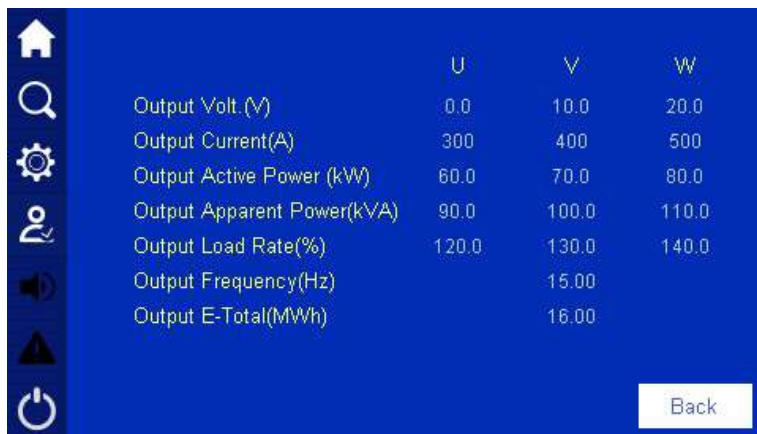

Figure4-20 Mains inversion status, battery charge

4.4.4 System Output Information Page

In main page, click  icon, it will enter system output information page, as shown in Figure4-21. In the page, it shows the current three-phase output voltage, current, active power, apparent power, load percentage and frequency.



	U	V	W
Output Volt.(V)	0.0	10.0	20.0
Output Current(A)	300	400	500
Output Active Power (kW)	60.0	70.0	80.0
Output Apparent Power(kVA)	90.0	100.0	110.0
Output Load Rate(%)	120.0	130.0	140.0
Output Frequency(Hz)		15.00	
Output E-Total(MWh)		16.00	

Back

Figure4-21 System output information

4.5 Information Query

In main page, click  icon, it will enter information query page, as shown in Figure4-22.

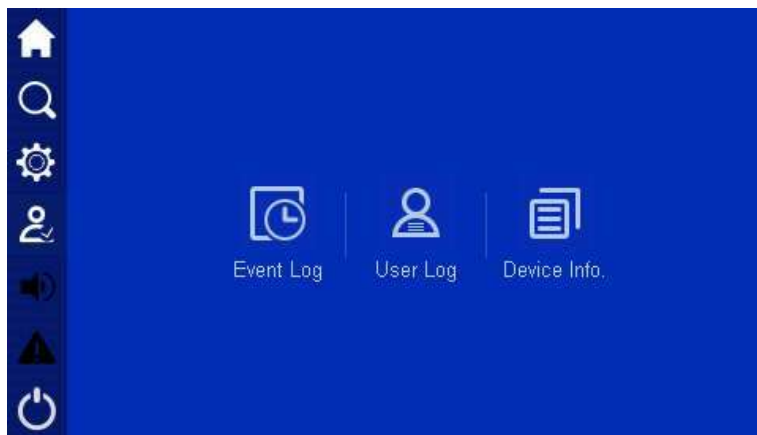

Figure4-22 Information query



CAUTION

It can record 9000 pieces information at most. When the record exceeds 9000 piece, the earliest information will be covered by new one. All records is ranked in inverted order of time.

4.5.1 Event Log

In information query page, click event log icon  , it will enter event log page, as shown in Figure4-23. This page records the history fault and alarm information of system and unit.

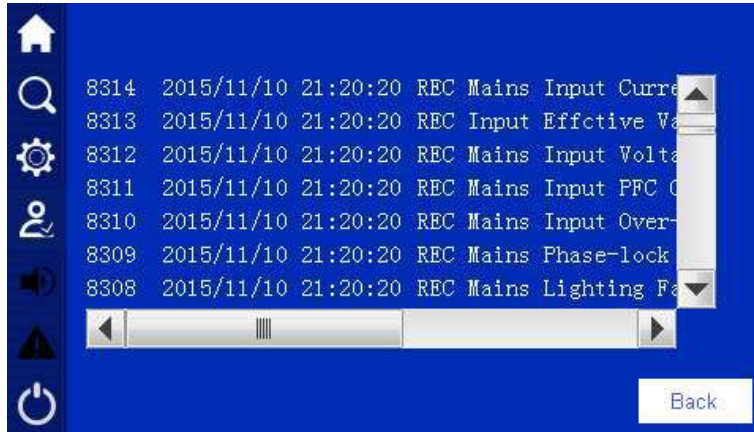



Figure4-23 History fault

4.5.2 User Log

In information query page, click user log icon  , it will enter user log page, as shown in Figure4-24. This page shows the user parameter setting record.

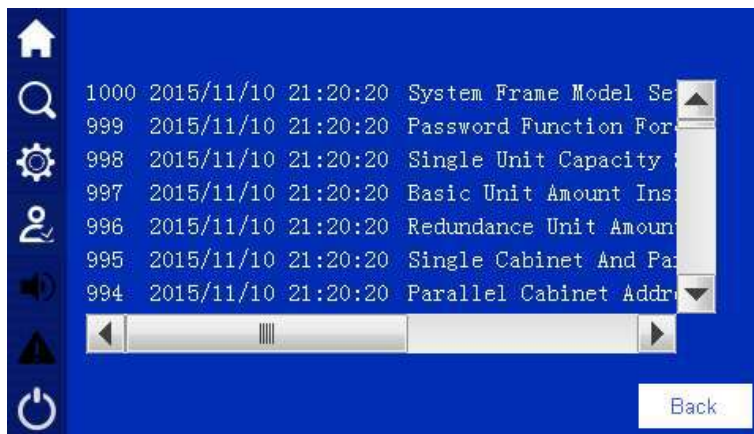

Figure4-24 User log

4.5.3 Device Information

In information query page, click device information icon  , it will enter product information page. This page shows the S/N, product name, model and status, as shown in Figure4-25, Figure4-26, Figure4-27, Figure4-28.



Figure4-25 Product information 1



Figure4-26 Product information 2





Figure4-27 Product information 3



Figure4-28 Product information 4

4.6 Setting Management

Click the  icon in main page and enter right password (as shown in Figure4-29), it will enter the main page, as shown in Figure4-30. After login, click  icon, it will enter system setting management page, as shown in Figure4-31.

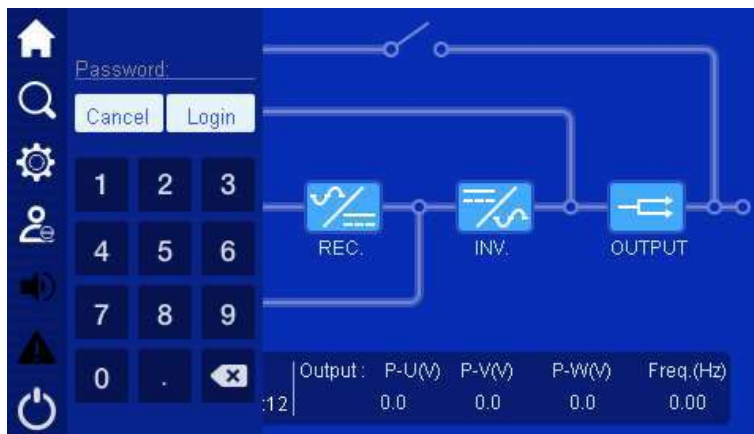

Figure4-29 Login page

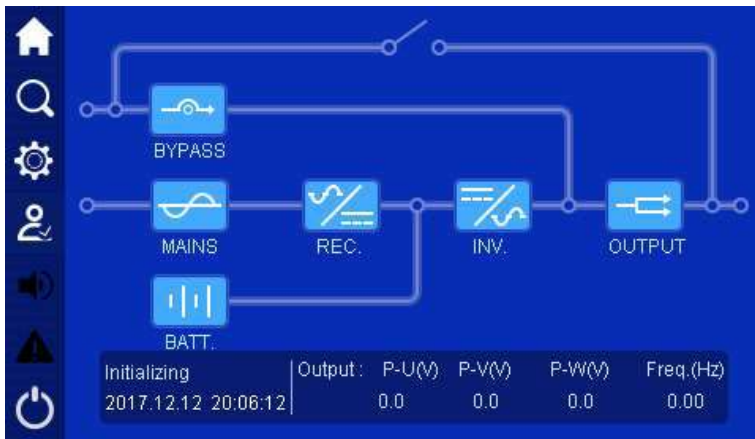

Figure4-30 Main page after login

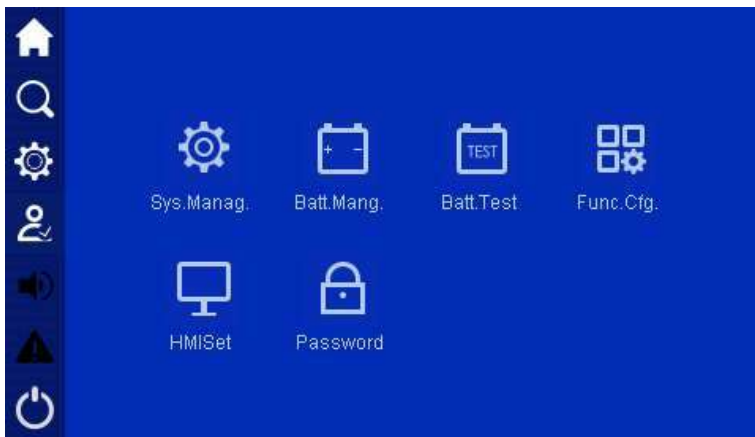



Figure4-31 Setting management page

4.6.1 System Management

In setting management page, click system management icon  , it will enter system management page. The page includes system setting, bypass setting, ECO setting.

System setting

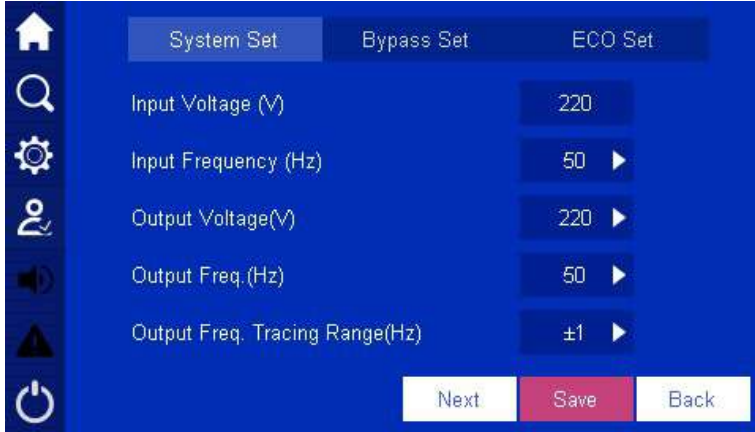

Figure4-32 System setting page 1

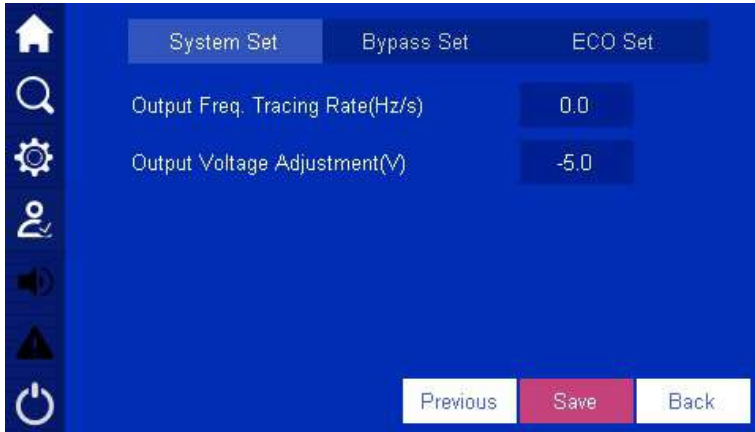



Figure4-33 System setting page 2

If setting successfully, at the right of the parameter will show  mark, as shown in Figure4-34. If setting failure, it will show  mark, as shown in Figure4-35.

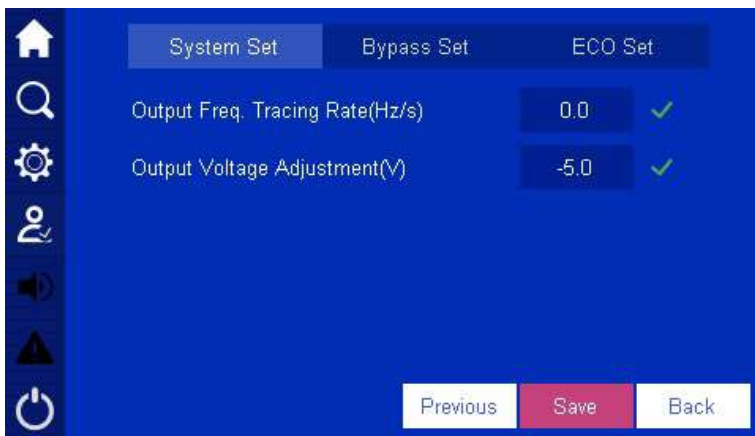

Figure4-34 Setting success

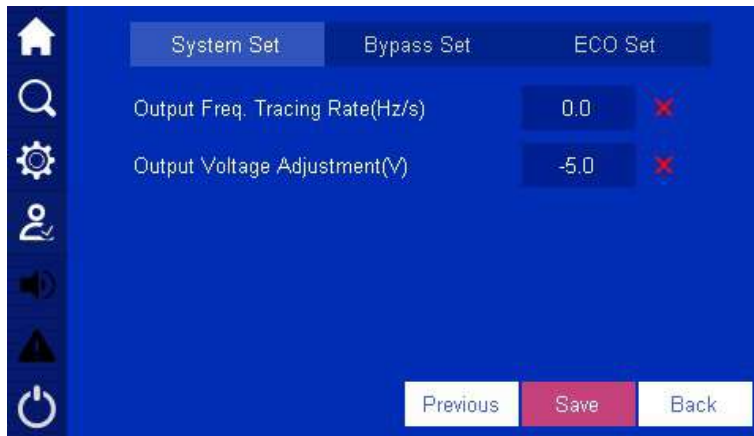

Figure4-35 Setting failure

Bypass setting

Click **Bypass Setting**, it will turn to bypass setting page, as shown in Figure4-36. Click enter box to change the parameter. Click **Save** button to save the setting. The marks of setting success and setting failure is the same as that of system setting.

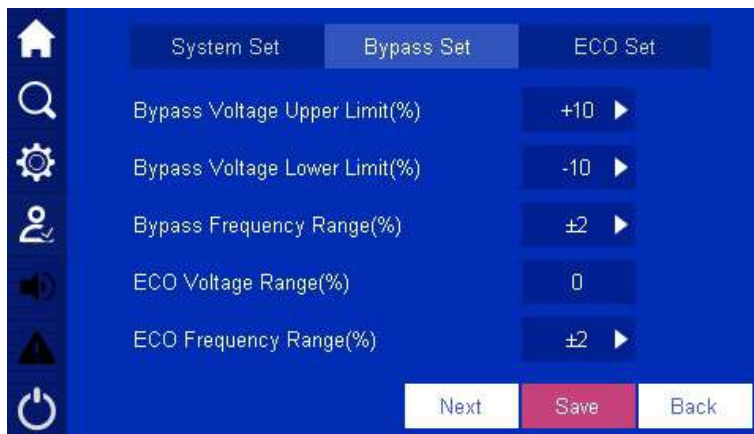

Figure4-36 Bypass setting 1



Figure4-37 Bypass setting 2

 **NOTE**

At the top of the enter box, it shows the max. and min. setting value of the setting item, and once the setting value exceeds the range, the setting will be invalid.

ECO setting

Click **ECO Setting**, it will turn to ECO setting page, as shown in Figure4-38. Click enter box to change the parameter. Click **Save** button to save the setting. The mark of setting success and setting failure is the same as that of system setting.



Figure4-38 ECO setting

4.6.2 Battery Management

In setting management page, click battery management icon  , it will enter the system management page. The page includes battery setting and charging setting, and can be changed by the top button. Click enter box to change the parameter. Click **Save** button to save the setting. The mark of setting success and setting failure is the same as that of system setting.

Battery setting



Figure4-39 Battery setting page 1



Figure4-40 Battery setting page 2



Figure4-41 Battery setting page 3

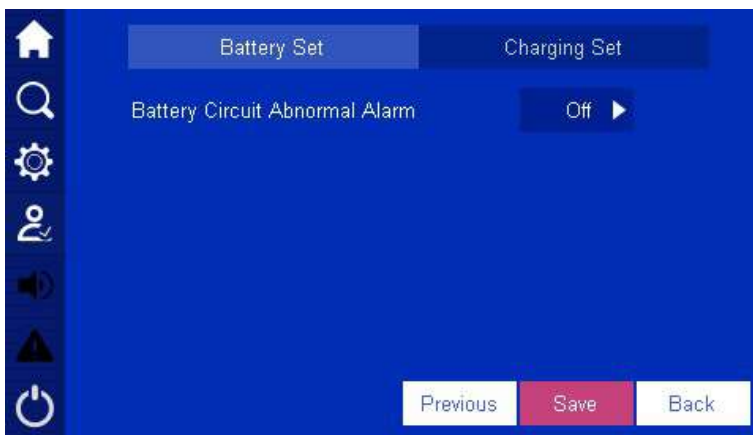

Figure4-42 Battery setting page 4

Charging setting



Figure4-43 Charge setting 1

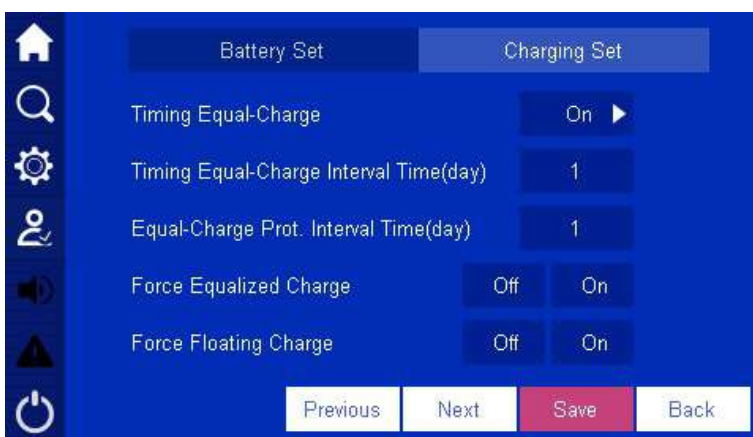



Figure4-44 Charge setting 2



Figure4-45 Charge setting 3

4.6.3 Battery Test

In setting management page, click battery test icon  , it will enter battery test page, as shown in Figure4-46.

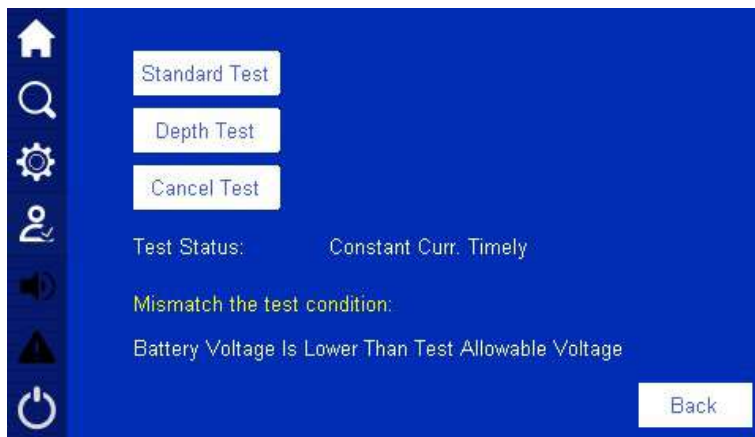



Figure4-46 Battery test

4.6.4 Function Configuration

In setting management page, click function configuration icon  , it will enter function configuration page. The page includes generator setting and dedusting setting, and can be changed by the top button. Click enter box to change the parameter. Click **Save** button to save the setting. The mark of setting success and setting failure is the same as that of system setting.

Generator setting



Figure4-47 Function configuration page

Dedusting setting

When the module works too long and the inner temperature rise is too large, you can perform the force dedusting operation. Click dedusting setting, enable the regular self-dedusting setting to start force dedusting. Once the output exceed 60% of rated output, it will not do the force dedusting operation.



Figure4-48 Dedusting setting page

4.6.5 HMI Setting

In setting management page, click HMI setting icon  , it will enter HMI setting page, as shown in Figure4-49.

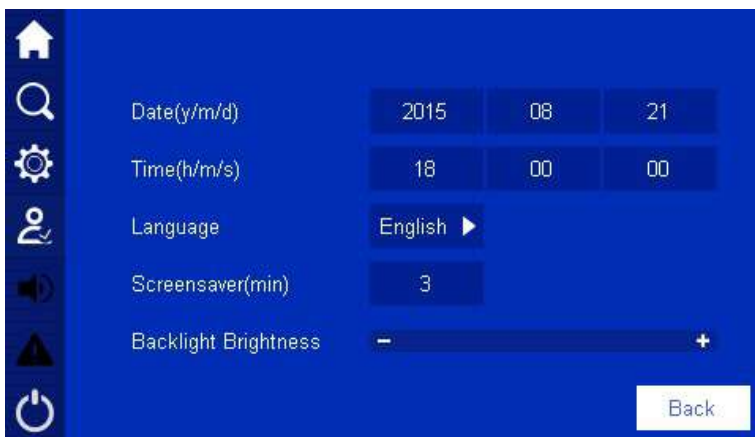



Figure4-49 HMI setting



CAUTION

When setting system time, ensure that the setting value is the same as the real time, which is to keep the veracity of system event log and master the system status of some time and maintain conveniently.

4.6.6 Password Setting

In setting management page, click password setting icon  , it will enter password setting page, as shown in Figure4-50. The password is the Arabic numerals from 1 place to 6 places. After modifying, click **Confirm** button to perform the modification.

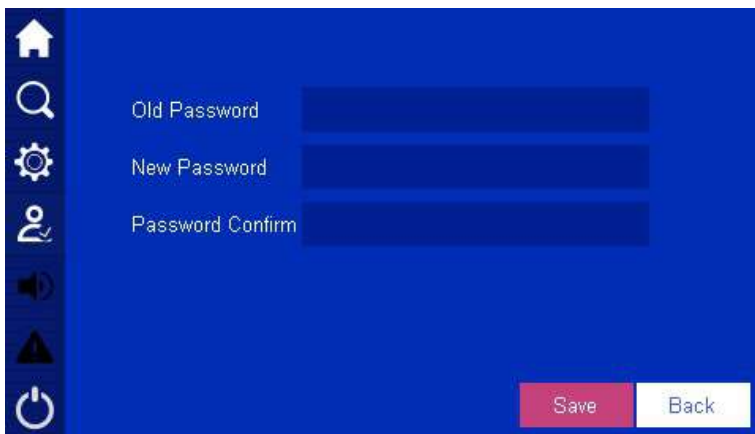



Figure4-50 Password setting

4.7 Buzzer Control

When unit or system abnormal, the system will send sound alarm. User can click the left buzzer indicator  icon to closed/open the buzzer. After closed, if a new fault happens, the buzzer will be opened automatically.

4.8 ON/OFF

In system setting page, click  icon, it will enter ON/OFF page.

While powering on, click  button, it will enter the ON/OFF page, as shown in Figure4-51, click **OK** button to perform the startup operation.

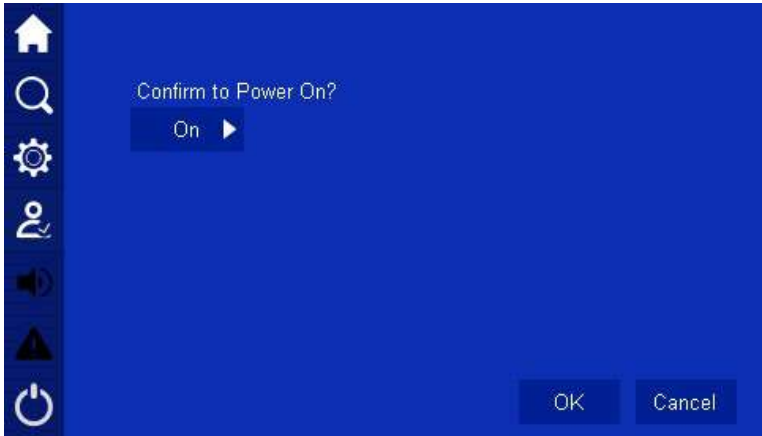



Figure4-51 Confirm to power on

While powering off, click  button, it will enter the ON/OFF page, as shown in Figure4-52, click **OK** button to perform the shutdown operation.

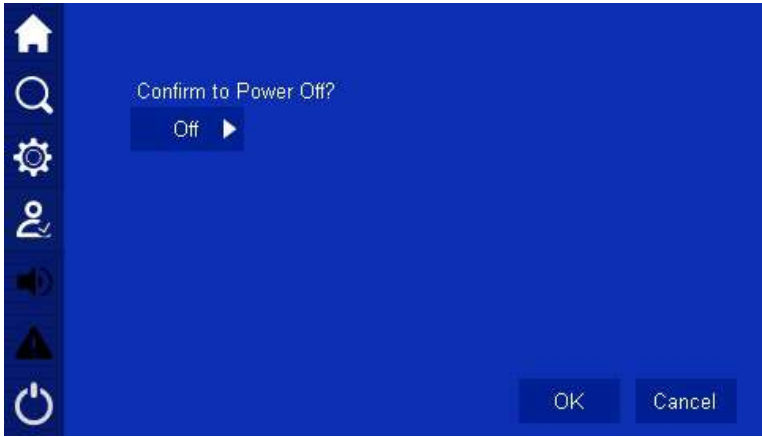

Figure4-52 Confirm to power off

5 Use and Operation

This chapter mainly introduces the operation procedure and method, including using announcements, operation procedure, UPS start and parallel system start, etc.

5.1 Use Announcements

- Before starting the UPS, check whether the load is proper. The load must not exceed the rated output power of the UPS, which is to avoid overload protection.
- Do not use the <ON> and <OFF> buttons on the UPS panel as the power supply switches of load. Do not start the UPS frequently.
- After UPS started and work stably, turn on the load. Start big-power devices before small-power ones. Some devices have large starting current which may cause overload protection, it is better to start these equipment before others. If the UPS needs to be shut down, turn off the load first.
- When mains power outage, if the UPS is power supplied by generator, it is necessary to start the generator firstly. After the generator work stably, the UPS can be connected, or it may cause UPS or load damage. If the generator needs to be shut down, turn of the UPS firstly.

5.2 Operation Procedure

Before first start the UPS, it is necessary to do the check, see section 5.3.1 .Only pass the examination, then you can power on the UPS. If the UPS won't be used for a long time, it also needs to be checked before startup. Operation procedure is as shown inFigure5-1.

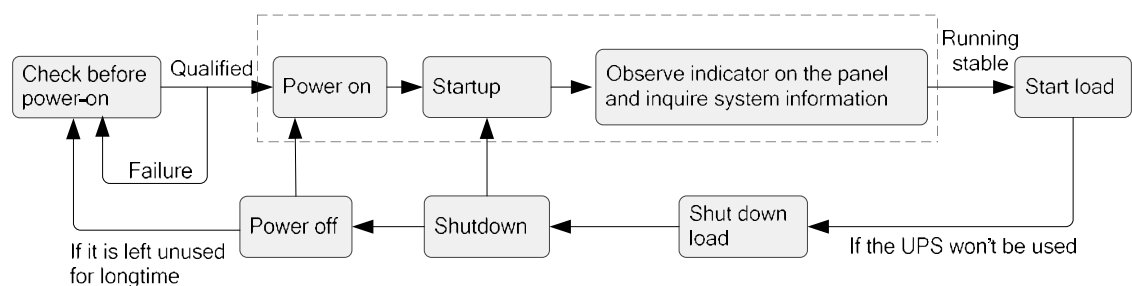

Figure5-1 Operation procedure

5.3 UPS Start and Shutdown

5.3.1 Check before Startup

Before startup, check according to following steps. Only when the check is OK, then the UPS can be started.

- Step 1 Ensure that the mains input breaker (POWER), bypass breaker (BYPASS), output breaker (OUTPUT), maintenance bypass breaker (MAINTENANCE) are all OFF.
- Step 2 Check load.
- Ensure that the load is not conductive load. The output of the UPS cannot be conductive load, such as motor, fan, air-condition, etc. Generally, these loads are power supplied by power-grid.
 - Ensure that the load is close. And at the same time, the load capacity should not exceed the UPS rated output capacity, or, it will cause overload protection.
- Step 3 Ensure that there is no short-circuit between the live wire and neutral wire, live wire and grounding wire of input and output.
- Step 4 Measure the AC voltage of mains input terminal (POWER), and the voltage should be within the range of 80V-280V, or, it can be started from battery status only.
- Step 5 Measure the DC voltage of battery input terminal (detailed position please see Figure3-20).The voltage of positive battery group should be greater than a certain value (+11.5× battery amount), the voltage of negative battery group should be less than (-11.5× battery amount), and pay attention to the polarity, avoid wrong battery connection.
- Step 6 Ensure that the auxiliary contact of battery breaker is connected to the ND4 dry contact of system monitor card at front of the UPS.

----End

5.3.2 Startup

- Step 1 Recheck all the system parameters setting and ensure that the setting is right.
- Step 2 Close the bypass breaker (BYPASS), ensure that the system bypass input is normal and with no output. The UPS is initializing. After initializing, the system will turn to bypass power supply. Look up the system running status in the touch screen, and ensure that the system is power supplied by bypass.

Step 3 Start the inverter.

- Start the UPS by panel combination button.
 1. Close the mains breaker (POWER).
 2. 30s later, long press the panel ON combination button for 3s, the system inverts to output. Check the system running status in the touch screen, and ensure that the system turns to inverter from bypass to supply power.
 3. Press the panel OFF combination button for 3s, the system turns to bypass power supply. Look up the system running status in the touch screen, and ensure that the system turns to bypass to supply power.
- Start the UPS by touch screen
 4. Click  icon in system management page, it will enter ON/OFF page, click **OK** button to perform the startup operation, as shown in Figure5-2.

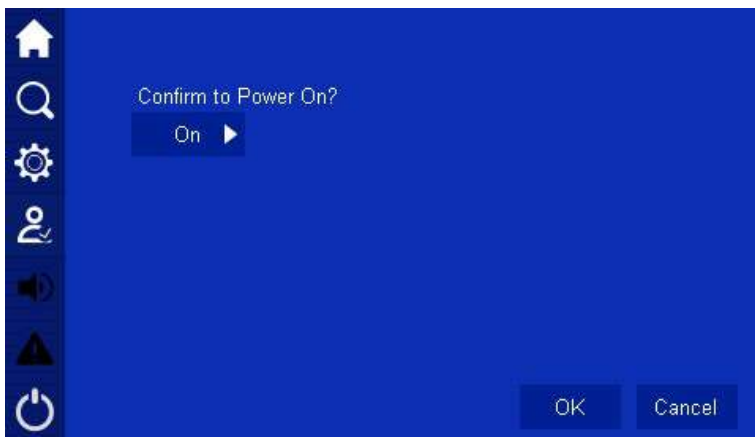

Figure5-2 Start confirmation page

5. After start the inverter, UPS turns to inverter to supply power, the bypass output alarm disappears. User can look up the system running status chart and ensure if the system turns to inverter to supply power. During testing, ensure that the UPS three-phase output voltage and frequency is normal through the real-time data in the touch screen. Measure the three-phase output voltage and frequency of output breaker or external output distribution breaker on output distribution cabinet and check if the voltage and frequency is normal.

Step 4 Close the output breaker of output distribution cabinet or external output distribution breaker to supply power for load.

5.3.3 UPS Shutdown



CAUTION

When the system bypass is normal, after the UPS shutdown, system will turn to bypass power supply mode; when system bypass is abnormal, after the UPS shutdown, system will be with no output. Before shutting down, please ensure that the load is closed.

- Shutdown by touch screen

Click the  icon in the main page, it will enter ON/OFF page, click **OK** to perform the operation, as shown in Figure5-3.



Figure5-3 Confirm to shutdown

5.3.4 Switch to Bypass Mode Manually



CAUTION

Before shutting down the inverter of UPS, please ensure that the bypass is normal. When bypass abnormal, after shut down the inverter manually, the system will be with no output and the power supply for load will break off.

Shut down the UPS inverter, please see **5.3.3 UPS Shutdown**. The UPS can be shutdown by touch screen or OFF combination button on the panel. System will turn to bypass to supply power automatically.

 **NOTE**

When the bypass input voltage or frequency exceeds the setting value, shutting down the inverter will cause system without output, and the power supply for load will be interrupted.

5.3.5 Switch to Maintenance Bypass Mode From Inverter Output

**CAUTION**

Unless professional person, no one can perform the following operation. Manufacturer does not take charge of the problem caused by the operation of untrained person.

- Step 1 In system management page, click the ON/OFF icon , it will enter ON/OFF page. Select **OFF** icon and press the **OK** icon for more than 3s, the inverter will be shut down.

 **NOTE**

The inverter also can be shut down by OFF combination button on the panel, but generally, it is not suggested to operate like this.

- Step 2 After switch to bypass and the energy flow on the touch screen show as bypass output, open the cover of manual maintenance breaker at the back of the cabinet, place the manual maintenance breaker to ON position.
- Step 3 Disconnect the bypass breaker (BYPASS), mains input breaker (POWER), output breaker (OUTPUT) (detail position please seeFigure2-8) and battery breaker of battery cabinet.

**CAUTION**

During maintenance, it is strictly forbidden to close the output breaker (OUTPUT).

----End

5.3.6 Switch to Inverter Output from Maintenance Bypass



CAUTION

Before perform the operation of switching to inverter power supply from maintenance bypass, please ensure that the system bypass input is normal.

- Step 1 Close the mains input breaker (POWER), bypass breaker (BYPASS), battery breaker of battery cabinet, output breaker (OUTPUT) successively.
- Step 2 After the power supply of UPS normal and the energy flow on touch screen shows bypass output, place the manual maintenance breaker at the back of the cabinet to OFF, at this time, the bypass supply power for load.
- Step 3 Start inverter system.

After the rectifier finish starting, click the ON/OFF icon  on touch screen, it will enter ON/OFF page. Select **ON** icon and press the **OK** icon for more than 3s, The load is switched to mains inverter mode.



NOTE

The inverter also can be started by ON button on the panel, but generally, it is not suggested to operate like this.

----End

5.3.7 Emergency Power Off (EPO)



CAUTION

Do not perform the EPO operation unless emergency.

Press the EPO button on the panel or external EPO button of system, the UPS will turn to emergency stop status. At this time, the touch screen shows EPO protection, system red AC/DC and DC/AC indicators on and the buzzer long beeps.

**CAUTION**

1. After pressing the EPO button, the UPS is with no output, the power supply for load is interrupted.
 2. When the system stay in maintenance bypass status, after pressing EPO button, the UPS still has output.
-

5.3.8 Emergency Power Off Recovery

- Step 1 Ensure that the dry contact of monitor card, which connected to the external EPO switch, is not in emergency power off status.
- Step 2 Disconnect the system input, output and battery breaker, until all system indicators are off, system power down completely.
- Step 3 Close the mains input breaker (POWER), bypass breaker (BYPASS), battery breaker, system will be started again, and EPO removes.

----End

5.4 Parallel System Startup and Shutdown

5.4.1 Start Parallel System

**CAUTION**

- Before start the parallel system, please perform the operation of **5.3 UPS Start and Shutdown** for each UPS.
 - Before power on and test the parallel system, please ensure that the wire connection of input and out cables and phase sequence is right and the parallel wire is well connected and stay in disconnection status.
 - Before completely starting the parallel system, please do not start load, and ensure that all switches of load are off.
 - Before performing the parallel wire operation, please do not connect the parallel wire.
-

- Step 1 Measure the front-end voltage and frequency of all UPS input (including mains input and bypass input) breaker or external input distribution breaker. Voltage range: 80V-280V, frequency range: 40Hz~60Hz (50Hz system) or 50Hz~70Hz (60Hz system) .
-

-
- Step 2 Connect the parallel wires, close the mains breaker and bypass breaker (keep all UPS breakers are off) of all UPS. If input power normal, rectifier will start automatically, the touch screen starts. Connect battery to parallel system.
- Step 3 Close battery breaker of each UPS's battery cabinet (if there are many groups battery, it is necessary to close each battery breaker and then close the total breaker between battery groups and UPS). Measure the voltage of battery breaker (if there are many groups battery, measure the voltage of each group battery, and then measure the voltage of total battery breaker). Ensure that the battery connection is proper (in 2min, all the "battery circuit abnormal" alarm on main page of the touch screen disappear).
- Step 4 Start each UPS. Ensure that all UPS stay in bypass power supply mode, and with no abnormal, switch on the external distribution switch, switch off the UPS output switch, and start the inverter of each UPS manually, all UPS turns to inverter power supply.
- Step 5 Measure the output voltage and frequency of each UPS. After each UPS turns to inverter power supply (user can check whether the system stay in inverter power supply mode through system running status), check whether the UPS three-phase output voltage and frequency is normal by the real-time data in touch screen, measure the front-end three-phase output voltage of output breaker of UPS, ensure that the inverter output voltage is normal (the three-phase output voltage = output voltage setting $\pm 2.0V$), and ensure that the inverter frequency is normal (the three-phase output frequency = output frequency setting $\pm 0.1Hz$). Record the measured three-phase voltage effective value of each UPS).
- Step 6 Switch off the output breaker of one UPS, and measure the voltage difference at the front and rear of the output breaker in any other UPS, ensure that the corresponding phase voltage effective value difference less than 5V, and then parallel the UPS. If it does not meet the requirement, the UPS with big voltage deviation cannot put into parallel system, and it is necessary to debug again.
- Step 7 Shut down the inverter of the UPS. Ensure that there is no abnormal of each UPS, shut down each UPS manually. All UPS turn to bypass power supply.
- Step 8 Check the bypass phase sequence.

Close the output breaker of UPS1 (ensure that the total breaker of load is disconnected, or once closing the output breaker of UPS1, it will supply power for load), maintain the output breaker of other UPSs is disconnected, keep the multimeter in AC position, one pen connect with the output breaker front-end phase-A of UPS2, the other pen connect with the output breaker back-end phase-A of UPS2, measure the voltage different between front-end and

back-end of UPS2 output breaker. Measure the voltage difference of phase-B and phase-Cas the same way. If the phase sequence is right, the voltage different of each should less than 5V; if the phase sequence is not right, there is at least one phase voltage difference greater than 5V. Measure whether the bypass sequence of each paralleled UPS is right (when measure other UPSs' phase sequence, it doesn't need to operate the breaker. Maintain the output of UPS1 is closed and the output breaker of other UPSs are not closed). If all bypass phase sequence of all UPS are right, go on the next step; if the phase sequence of any one UPS is not right, power off the system and check the input and output wiring of each UPS is right.

Step 9 Close the output breaker of all UPS.

Ensure that each UPS is with no abnormal, close the output breaker of all UPS successively. Ensure that the output end of all UPS stay in parallel status.

Step 10 Start the inverter of each UPS.

Ensure that the system is with no abnormal, manually start each UPS successively. System start inverter power supply. Monitor that there is no abnormal alarm.

Step 11 Shut down the inverter of each UPS.

Ensure that each UPS is with no abnormal, shut down the inverter of all UPS, the system turns to bypass power supply.

Step 12 Close the total output breaker of load.

After the parallel system turns to bypass power supply, close the total output breaker of load, system bypass supplies power for load.

Step 13 Start each UPS successively, the system turns to inverter power supply.

----End

5.4.2 Shutdown Parallel System



CAUTION

If the system bypass is normal, after shutting down the UPS, the system will turn to bypass power supply mode; if the system bypass is abnormal, after shutting down the UPS, the system will turn to no output mode, the system output is outage.

Before shutting down, please ensure that load is closed and can endure the status of power outage at any time.

- Step 1 Close the load of parallel system, keep the UPS run without load for 5min to eliminate inner heat.
- Step 2 Perform 5.3.3 UPS Shutdown to close all UPS, system turns to bypass power supply.
- Step 3 Disconnect the load total breaker, each UPS output breaker (OUTPUT), battery breaker, battery breaker (BYPASS), mains input breaker (POWER) successively.

----End

 **NOTE**

If it just needs to close the UPS, system turns to bypass power supply and the load without power outage, just perform Step 2; if it needs to power off all UPS system, perform all above steps.

5.4.3 Emergency Power Off (EPO)

Single UPS running

Press the EPO button of the UPS or the EPO button of total system, the UPS will shut down and close all output.

Multi UPS running in parallel system

- EPO linkage is enabled

Press the EPO button of the UPS or the EPO button of total system, all the paralleled UPS will shut down and close all output.

- EPO linkage is not enabled

Press EPO button of one UPS, the output of this UPS will be closed.

Press the EPO button of total system, all paralleled UPS will be shut down and all output will be closed.

6 Maintenance and Troubleshooting

6.1 Maintenance Guide

Proper maintenance is the key to make the device operate in the best status and with a longer service life.

6.1.1 Safety Precautions

To ensure human safety and equipment security, observe the following precautions.

- Please keep in mind that there is dangerous voltage inside the UPS even if the UPS does not operate. Before maintenance, use a multi-meter to check the voltage and make sure that the UPS is completely shut down and stays in safe status.
- Before close the battery breaker at any time, use a multi-meter to measure if the voltage of multi-meter is normal and the polarity is reverse connected. If the result is abnormal, it is strictly forbidden to close the battery breaker.
- Do not wear any conductive metal objects during operation, such as ring, watch.
- Observe safety regulations strictly. If any doubt, consult professionals.

6.1.2 Preventive Maintenance

To improve the UPS reliability and efficacy, perform the following maintenance tasks on a quarterly basis.

- Keep the operating environment free from dust and chemical pollutants.
- Check if the wiring terminals on input, output cables are in good contact every half year.
- Check the fans work status periodically and avoid blocking the air vents. If a fan is damaged, maintain or replace it in time.
- Check the voltage of batteries periodically and ensure that the battery voltage is within the normal range.
- Check the UPS status periodically and ensure that any fault can be found in time.

6.2 Battery Maintenance

- Battery charge requirements

- When first use the battery, please start the UPS and charge the battery for 24h. during charging, the UPS still can be used, but if power outage occurs at the same time, the battery discharge time may less than the standard vale this time.
- Generally, the battery needs to be charged and discharged every 4 to 6 months. First, discharge till battery low-voltage alarm and then charge the battery. The charge time of each time cannot less than 24h.
- In high temperature area, the battery needs to be charged and discharged every 2 months and the charge time of each time cannot less than 24h.
- If the battery will not be used for long time, it also needs to charge the battery every 3 months and the charge time of each time cannot less than 24h.
- Clean battery shells by water-dipped cloth. Oil and organic solvents, such as petrol and diluents are prohibited.
- To avoid explosion, keep batteries far away from fire sources and devices that easily generate sparks.
- Avoid over-discharge the battery during using. Fully charge the battery immediately after discharge (24h at latest) and then the battery can discharge again. It is strictly forbidden to discharge the not fully charged battery, or, it will cause battery capacity decrease even damage battery.
- To avoid battery discharging for too much time after mainspower outage, disconnect the battery breaker when the UPS is not used.

6.3 Announcementsfor Battery Replacement

- Dangerous voltage may exist in the battery terminal and grounding terminal, before touching, please measure if there is dangerous high voltage, which is to avoid endanger human safety. It is strictly forbidden to touch the two wiring pillars or the bare end of battery.
- The battery should be replaced in whole group, do not use the new battery and old battery together.
- A new battery should be with the same capacity, model, and manufacturer as the replaced one. The battery with different capacity, different type and different manufacturer battery is strictly forbidden to use together.
- Recycle the battery according to the relative illustration on the battery.
- Do not put the battery into fire, which is to avoid explosion.

- Do not open or disassemble the battery, for the inner electrolyte is harmful for skin and eyes.

6.4 Troubleshooting

6.4.1 Common Abnormal Phenomena Diagnosis

If the UPS works abnormally after start, please refer to Table6-1 to find possible reason. Meanwhile, check whether the fault is caused by external environment, such as temperature, humidity is not accordance with the requirement or overload.

Table6-1only includes some simple diagnosis. If the diagnosis is not clear, or not sufficient to solve the problem, please contact with local agency or dealer to deal with.

Table6-1 Troubleshooting

NO	Abnormal phenomena	Possible reason
1	Mains normal, but UPS works in battery inverting status, the buzzer beeps intermittently.	Each connection point, socket of grid feed circuit is not so good, which causes the AC power supply input unblocked.
2	After installation, close breaker or switch of power supply, it will fuse the fuse or trip off.	The three-phase input wires are wrongly connected, such as neutral wire and ground wire or live wire and grounding (case) is wrongly connected or the three-phase output wire is wrongly connected.
3	After startup, the UPS outputs 220V AC power, but the UPS works in bypass status.	<ol style="list-style-type: none"> 1. The load it too large and exceed the rated output capacity of the UPS. It needs to reduce load or select a UPS with larger output capacity. 2. If it is temporary bypass caused by the impact of load startup, and it can recover to normal automatically, that is normal.

NO	Abnormal phenomena	Possible reason
4	The UPS output normally after startup, but once turn on load, the UPS stop outputting immediately.	<ol style="list-style-type: none"> 1. The UPS is serious overload or the output circuit is short-circuit. It is necessary to reduce load to proper capacity or find the reason of short-circuit. Common reason is output socket is short circuit or input short circuit caused by device damage. 2. The load is not started according to the sequence from large power device to small power device. You should restart the UPS. After the UPS run stably, start the load according to the sequence from large power device to small power device.
5	The UPS work normally after startup, but some time later, the UPS shut down automatically.	<p>At the status of battery supply power, the battery is runs out and system protects for battery under-voltage, the UPS shut down automatically. This phenomenon is normal. Once mains normal, system will start and charge battery automatically.</p> <p>Warning: if the battery stays in under-voltage status for long time, it will influence the battery service life. After battery under-voltage protection, if mains cannot recover in a long time, please disconnect the battery breaker to protect battery and restart the UPS and fully charge the battery once mains recovers.</p>
6	After startup and work a period of time, buzzer long beeps and the touch screen shows battery low-voltage.	The mains voltage is too low, and the UPS works in battery inverting status, finally, the battery is under-voltage and causes under-voltage protection.

NO	Abnormal phenomena	Possible reason
7	When there is mains, the UPS output normally, when there is no mains, the UPS is with no output.	1. Battery fault or the battery group is serious damaged. 2. Charger fault. The battery cannot be charged and causes battery energy insufficient. 3. Battery wire is not well connected or the contact of wire terminal is not good. 4. Battery breaker is not closed. 5. After serious overload of UPS, the UPS is not restarted, which causes the UPS stay in bypass output status.
8	Buzzer long beeps, DC/AC indicator on, the UPS turns to bypass to supply power.	See the fault information on touch screen.
9	There is mains, but buzzer beeps intermittently.	The voltage or frequency of mains exceed the allowable range of the UPS.
10	At mains status, the UPS works normally, once power outage, the UPS works normally but load system halt.	The grounding is not so good and the float voltage between neutral wire and grounding wire is too large.
11	FAULT indicator of a power unit is on.	The power unit is fault, replace it in time.

6.4.2 Emergency Dispose for System Fault

- How to deal with the system fault in emergency

When system fault, shut down the power supply of UPS by the touch screen, if necessary, close the user load and disconnect the input and output breaker of the UPS to avoid further damage for the UPS. Inform the engineering technician to maintain.

- How to deal with the fault of single power unit in emergency

When some power unit fault, it will be insulated with system automatically, and generally, it will not influence the system normal operation, but it will decrease the redundancy degree of

the unit. At this time, please shut down the fault unit and pull it out of the cabinet, and then inform the engineering technician to maintain.

After pulling out the unit, there still has high voltage inside the unit and on the rear connector pin. It is necessary to wait enough time (≥ 10 min) and then open the cover to maintain.

7 Package, Transportation and Storage

7.1 Package

During packing, please pay attention to the place direction requirements. At the side of the package, there is afraid of wet, handle with care, upward, stack layer limit, etc. alarm marks. And also, the device model is pasted on the package. At front of the package, the LOGO of our company and device name is printed.

7.2 Transportation

During transporting, pay attention to the alarm marks and avoid severe impact on the device. Place the device according to the marked direction, which is to avoid damage the component. Any inflammable, explosive, corrosive object is not allowed to shipping with the device. While midway transportation, do not put the device in the open air. The device cannot suffer any rain, snow or liquid material or mechanical damage.

7.3 Storage

When storing the device, place the device according to the marked direction. The package box should be far away from ground for 200mm, and keep at least 500mm from wall, eat source, cold source, window or air inlet.

Storage temperature: -20-50°C. If the device is transported or stored out of the storage temperature, before installation and startup, put the device aside and let the device temperature recover to normal range for more than 4h. In the warehouse, any inflammable, explosive, corrosive object or harmful gas is not allowed, and also, strong mechanical shake, impact or magnetic field is forbidden. The storage period of these requirements, generally, is 6 months. If the device stored more than 6 months, it is necessary to check again. If the device is stored for a long time, please charge the battery every 3 months.

A Technical Specifications

Index		Model	10kVA	20kVA	50kVA	80kVA	100kVA	160kVA	200kVA
			30kVA	40kVA	60kVA	140kVA			
Input	Input mode	3φ4W+PE							
	Rated input voltage (VAC)	220/230/240 (phase voltage)							
	Input voltage range	Vin=176Vac~280Vac, Do not decrease rated power to use. Vin=80Vac~175Vac, Linear decrease rated power to use.							
	Input frequency range (Hz)	40~70							
	Bypass synchronization tracking range (Hz)	50/60±6							
	Bypass input voltage	220/230/240 (phase voltage)							
	Input power factor	≥0.99							
	Input THDI	Resistive full load:≤3%; non-linear full load:≤5%							
	Battery (VDC)	±180~±240 (can be selected from ±15cells~±20cells, default is ±16 cells)							
	Charge current (A)	10	20	20	30	40	50		
Output	Output mode	3φ4W+PE							
	Output wave	Sine-wave							

Index	Model	10kVA	50kVA	80kVA	100kVA	160kVA	200kVA
		20kVA	60kVA		140kVA		
		30kVA					
		40kVA					
	Voltage (Vac)	L—N: 220/230/240 L—L: 380/400/415					
	Frequency (Hz)	When mains normal, it tracks the bypass input; When mains abnormal, it tracks the frequency of the UPS in the range of 50±0.1 or 60±0.1.					
	Three-phase phase error	With three-phase rated balance resistive load≤1°					
	Wave form distortion (THDv)	Resistive full load≤1%; non-linear load≤4%					
	Bypass inversion switch time	Synchronization < 0ms; Unsync:<15ms					
	System efficiency	96%					

Index	Model	10kVA	50kVA	80kVA	100kVA	160kVA	200kVA
		20kVA			60kVA		
	Overload capacity	<p>Inverter overload capacity:</p> <p>When the load less than 105% rated load, it runs normally.</p> <p>When the load in the range of 105%~115% rated load, it will turns to bypass 60min later.</p> <p>When the load in the range of 116%~130% rated load, it will turns to bypass 10min later.</p> <p>When the load in the range of 131%~150% rated load, it will turns to bypass 1min later.</p> <p>When the load in the range of 151%~250% rated load, it will turns to bypass 200ms later.</p> <p>When the load greater than 251% rated load, it will turns to bypass 10ms later.</p> <p>Bypass overload capacity:</p> <p>When the load less than 130% rated load, it runs normally.</p> <p>When the load in the range of 131%~150% rated load, it can maintain 10min.</p> <p>When the load greater than 150% rated load, it can maintain 100ms.</p>					
	Current-equalized precision	≤5%					
	Output DC component	-200mV~+200mV					
	Dynamic response transient range	When the load changes in the range of 0%~100% or 100%~0%, the output voltage≤5%					
	Load unbalance capacity	Can bear 100% unbalance load					
	Manual maintenance bypass	It equips the maintenance bypass switch without switch time.					
Q1	DC start function	Equipped					

Index	Model	10kVA	50kVA	80kVA	100kVA	160kVA	200kVA
		20kVA					
		30kVA					
		40kVA					
Touch screen display	Three-phase input voltage, input frequency, three-phase output voltage, load, battery voltage, battery charge & discharge current, each unit output current and inner temperature, parameter setting, hIST7ory record, etc.						
LED display	Work status and fault indication of UPS.						
Alarm function	Alarm for input abnormal, battery low-voltage, overload, fault, etc.						
Communication function	Provides dry contact communication and RS485, and it can also equip with SNMP to realize the smart monitor for the UPS.						
Battery monitor function (optional)	MMBM-3 battery monitor manage system, realizes the work status monitor of single battery.						
Protection function	Protect for output short-circuit, output over-voltage/ under-voltage, overload, over-temperature, battery under-voltage, etc.						
EMC	Meet the provision of GB7260.2-2009						
Noise (dB)	< 70 (measured away from the front cabinet for 1m)						
Cooling way	Forced wind-cooling						
Work temperature (°C)	0~40						
Size (W×D×H) (mm)	320*840*86 7	450*840*96 7	450*840*1400		600*900*1600		
Weight (kg)	120	160	210	242	300	342	

- Specifications are subject to change without prior notice.

